

SUPEROFFERTA
2022



**AVVITA LUI.
STRINGI TU.**

€ Senza IVA 62/2022
Valida fino al 31/01/2023

0		280 LTSTX/S8	PAG. 41	468 M	PAG. 87	519/276	PAG. 28	519 RS7/5V	PAG. 8	922 B2	PAG. 95
001 RV	PAG. 32	280 TK/SE6	PAG. 42	493 A	PAG. 73	519/280HG	PAG. 28	519 RS8/3V	PAG. 8	922 BL1	PAG. 95
001 TRV	PAG. 32	280 T/SE7	PAG. 42	493 B	PAG. 73	519/280HGTS	PAG. 28	519 RSC4/3V	PAG. 9	922 BP1	PAG. 95
002 JMA	PAG. 30	280 TTS/SE6	PAG. 42	493 C	PAG. 73	519/280T	PAG. 28	519 RSC4/4V	PAG. 9	923 A	PAG. 94
002 JTMA	PAG. 30	280 TTX/SE8	PAG. 42	495 098HYB	PAG. 77	519/285A1	PAG. 28	519 RSC4/5V	PAG. 9	926 A	PAG. 67
002 UDE	PAG. 31	280 XLTS/S9	PAG. 41	495 MAA	PAG. 26	519/285B2	PAG. 28	600		928 AC1 1/2"	PAG. 92
002 UDM	PAG. 31	282 S10	PAG. 72	495 MB	PAG. 26	519/285KA1	PAG. 28	601 1/2 J22	PAG. 56	928 D1 3/4"	PAG. 93
007/1V	PAG. 34	285 DS8	PAG. 48	495 MC	PAG. 26	519/294	PAG. 28	601 1/4-1/2 J82	PAG. 57	929 PC1 1/2"	PAG. 90
007 FTSV	PAG. 35	285 J/B16	PAG. 57	495 PA	PAG. 27	519/322H	PAG. 28	601 1/4-1/2 J100	PAG. 57	929 PC1/C12	PAG. 91
007 MLV	PAG. 65	285 KA/DS8	PAG. 49	495 PM	PAG. 27	519/322STX	PAG. 28	601 1/4-1/2 JTX16	PAG. 56	939 C1	PAG. 94
007 MV	PAG. 65	285 KA/DS12	PAG. 49	500		519/324H	PAG. 28	601 1/4 J34	PAG. 56	942 PC3 1/2"	PAG. 90
007 RV	PAG. 35	285 KB/SR8	PAG. 50	504 S	PAG. 15	519/324TX	PAG. 28	604 1/2" ED	PAG. 53	942 PC3/C7	PAG. 91
007 SV	PAG. 35	285 KF/DS8	PAG. 50	506 BA	PAG. 23	519/366	PAG. 28	605 1/4" ED	PAG. 53	942 PD1 3/4"	PAG. 93
007 TV	PAG. 35	285 L/SE4	PAG. 50	506 BAC/2000	PAG. 23	519/382F	PAG. 28	606 1/2" EA	PAG. 52	942 PE1 1"	PAG. 93
007 TXV	PAG. 34	285 SE26	PAG. 48	506 BL	PAG. 23	519/613AEA	PAG. 28	606 1/4" EA	PAG. 52	942 PEL2 1"	PAG. 93
007 V	PAG. 34	294 AC	PAG. 47	506 BLC/2000	PAG. 23	519/613BEA	PAG. 28	606 1/4" SK	PAG. 54	943 PC1 1/2"	PAG. 90
074 A	PAG. 65	294 AD	PAG. 47	516 AC1	PAG. 13	519/613CEA	PAG. 28	608 1/4" EAK	PAG. 55	943 PC1/C12	PAG. 91
076 G	PAG. 65	294 AG	PAG. 47	516 AC2	PAG. 13	519/990A1	PAG. 28	609 1/4" EB	PAG. 54	943 PC2 1/2"	PAG. 92
085 EX/SE3	PAG. 44	299 SE4	PAG. 51	516 AC3	PAG. 13	519 ACT1	PAG. 7	610 1/4" EFK	PAG. 54	988 D/S3	PAG. 70
091 D/SH5	PAG. 39	300		516 AC4	PAG. 13	519 ACT2	PAG. 7	612 3/4" B	PAG. 55	988 E/S10	PAG. 70
091 SH5	PAG. 39	305 N	PAG. 68	516 AC5	PAG. 13	519 ACT3	PAG. 7	612 3/4" EB	PAG. 55	988 G/S12	PAG. 70
091 SH8	PAG. 39	307 A/S7	PAG. 68	516 AC6	PAG. 13	519 ACT4	PAG. 7	618 MF1	PAG. 72	988 LA/S14	PAG. 70
098 3/8" HYB8	PAG. 77	314 C	PAG. 68	516 AC7	PAG. 13	519 ACT5	PAG. 7	618 MF2	PAG. 72	988 MA/S19	PAG. 70
099 BG	PAG. 76	317 K	PAG. 68	516 AC8	PAG. 13	519 ACT6	PAG. 7	640 A	PAG. 33	988 MA/S25	PAG. 70
099 FS	PAG. 76	322 SH7	PAG. 39	516 AC9	PAG. 13	519 ACT7	PAG. 7	641 T	PAG. 32	995 A	PAG. 67
099 G	PAG. 76	322 SH10	PAG. 39	516 AC10	PAG. 15	519 ACT8	PAG. 7	646/5LV	PAG. 33	995 AF	PAG. 67
099 H	PAG. 76	324 L/SH5	PAG. 37	516 SA/C1	PAG. 20	519 ACT9	PAG. 7	664 B/S7	PAG. 40	995 CA	PAG. 66
099 L	PAG. 76	324 LTX/SH5	PAG. 86	516 SA/C2	PAG. 20	519 ACT10	PAG. 7	664 S25	PAG. 40	995 LA	PAG. 66
099 TG	PAG. 76	324 SH5	PAG. 36	516 SA/C3	PAG. 21	519 ACT11	PAG. 7	687 1/2" C16	PAG. 96	997 A	PAG. 71
100		324 SH8	PAG. 36	516 SA/C4	PAG. 21	519 ACT12	PAG. 7	688 3/4" MD6	PAG. 96	997 B	PAG. 71
115 CL/SE2	PAG. 86	324 SH12	PAG. 37	516 SA/CA1	PAG. 20	519 ACT13	PAG. 7	692 J32	PAG. 40	1000	
127 C/SE4	PAG. 45	324 STX/S7	PAG. 37	516 SA/CA2	PAG. 20	519 ACT14	PAG. 7	692 J49	PAG. 40	1612 BA12	PAG. 79
127 C/SE4S	PAG. 45	324 XP/B16	PAG. 5	516 SA/CA3	PAG. 21	519 ACT15	PAG. 9	692 J100	PAG. 41	1612 BA24	PAG. 79
127 N/SE4	PAG. 45	333 K/SB10	PAG. 38	516 SA/CA4	PAG. 21	519 M 091A	PAG. 29	700		1613 AGM12-24	PAG. 78
127 N/SE4S	PAG. 45	333 K/SC23	PAG. 38	516 SPC1	PAG. 22	519 M 127N	PAG. 29	751	PAG. 64	1613 OBD	PAG. 79
146 B	PAG. 64	333 K/SH8	PAG. 38	516 SPC2	PAG. 22	519 M 150AX	PAG. 29	753 KA	PAG. 64	1613 RA12	PAG. 78
150 AX/SE3	PAG. 44	341 SH33	PAG. 64	516 SPCN1	PAG. 22	519 M 276	PAG. 29	767	PAG. 64	1651	PAG. 79
155 AX	PAG. 44	367 SE6	PAG. 69	516 SPCN2	PAG. 22	519 M 280HG	PAG. 29	800		1785 B	PAG. 89
163	PAG. 64	376	PAG. 69	516 ST5HYA-S	PAG. 77	519 M 280HGTS	PAG. 29	810 N	PAG. 61	1881 S22	PAG. 79
174 CX	PAG. 46	382	PAG. 69	516 ST5V	PAG. 14	519 M 280N1	PAG. 29	810 SA	PAG. 60	1950 C	PAG. 82
200		391	PAG. 86	516 ST6MA	PAG. 17	519 M 280TK	PAG. 29	811 NE	PAG. 61	2000	
200 S	PAG. 71	400		516 ST6MM	PAG. 17	519 M 285A1	PAG. 29	811 SE	PAG. 60	2000 A	PAG. 89
207 D	PAG. 63	400 P	PAG. 88	516 ST6NMA	PAG. 17	519 M 285A2	PAG. 29	812 N	PAG. 61	2550 A	PAG. 82
207 E	PAG. 63	426 B/S5	PAG. 88	516 ST6NMM	PAG. 17	519 M 285KA	PAG. 29	814 A	PAG. 62	2550 B	PAG. 82
233 1/2" MNTX/C6	PAG. 96	426 C/S4	PAG. 88	516 ST6NPA	PAG. 16	519 M 322H	PAG. 29	824 A	PAG. 61	2847/3	PAG. 81
235 1/2" MB/C10	PAG. 98	426 D/S4	PAG. 88	516 ST6NPM	PAG. 16	519 M 322STX	PAG. 29	828 X4	PAG. 62	2847 N4	PAG. 81
235 1/2" M/C16	PAG. 97	426 SAB	PAG. 88	516 ST6NUD-796	PAG. 19	519 M 324H	PAG. 29	831 A	PAG. 62	3000	
235 3/4 M/C8	PAG. 97	443 N	PAG. 84	516 ST6NUD-894	PAG. 19	519 M 324STX	PAG. 29	870 C	PAG. 87	3781 A	PAG. 89
235 3/4 MLS	PAG. 83	443 NC	PAG. 84	516 ST6NV	PAG. 14	519 M 382F	PAG. 29	871 C	PAG. 87	3781 C	PAG. 89
236 K	PAG. 99	445 B	PAG. 83	516 ST6PA	PAG. 16	519 M 613AEA	PAG. 29	871 D	PAG. 87	3781 D	PAG. 89
236 KE	PAG. 99	446 DA/SE6	PAG. 84	516 ST6PM	PAG. 16	519 M 613BEA	PAG. 29	884 C/S6	PAG. 87	3781 E	PAG. 89
236 KE/C22	PAG. 99	446 DC	PAG. 85	516 ST6UD-796	PAG. 19	519 M 613CEA	PAG. 29	885 F	PAG. 87	5000	
237 1/2" AK	PAG. 55	446 DT/S2	PAG. 85	516 ST6UD-894	PAG. 19	519 M 990A5MD	PAG. 29	889 LTE	PAG. 75	5003/1	PAG. 33
237 1/4" AK	PAG. 55	446 E/SE2	PAG. 84	516 ST6V	PAG. 14	519 RBO7/3V	PAG. 9	889 RD	PAG. 74	5006 EF2	PAG. 25
237 D	PAG. 53	446 RT	PAG. 83	516 ST7NV	PAG. 14	519 RBU6/3V	PAG. 9	889 RP	PAG. 75	5006 EF6	PAG. 25
252 N/SR8	PAG. 51	447 T	PAG. 80	516 ST7V	PAG. 14	519 RS6/3MA	PAG. 10	889 RT	PAG. 75		
263/S16	PAG. 85	449 IDA	PAG. 83	516 STC4V	PAG. 15	519 RS6/3MM	PAG. 10	889 SA	PAG. 74		
270 BM	PAG. 81	449 TA	PAG. 83	516 STS6NV	PAG. 14	519 RS6/3NMA	PAG. 10	889 TR	PAG. 74		
270 C/C3	PAG. 81	449 TB	PAG. 83	516 STXL6MM	PAG. 18	519 RS6/3NMM	PAG. 10	890 K	PAG. 79		
272 DS	PAG. 80	449 TC	PAG. 83	516 STXL6NMM	PAG. 18	519 RS6/3NV	PAG. 8	900			
276 CE/SE8	PAG. 51	451 N/S4	PAG. 59	516 STXL6NV	PAG. 14	519 RS6/3V	PAG. 8	913 PB2 3/8"	PAG. 92		
280 HAP/SE6	PAG. 43	454	PAG. 59	516 STXL6V	PAG. 14	519 RS6/4MM	PAG. 11	913 PC2 1/2"	PAG. 92		
280 HATX/SE6	PAG. 43	458 E/B9	PAG. 58	516 SU2V	PAG. 15	519 RS6/4NMM	PAG. 11	920 AN1	PAG. 94		
280 HG/SE6	PAG. 43	458 S6	PAG. 59	516 SUXLV	PAG. 15	519 RS6/4NV	PAG. 8	921 A4	PAG. 94		
280 HGTS/SE6	PAG. 43	458 S20	PAG. 58	519/127N	PAG. 28	519 RS6/4V	PAG. 8	921 B1	PAG. 95		
280 LTS/S9	PAG. 41	460 A	PAG. 59	519/150AX	PAG. 28	519 RS7/3V	PAG. 8	922 B1	PAG. 95		

SCOPRI LE NOVITÀ 2022

Indice per categorie

NEW



Giravite elettrico
Pagina 4

NEW



Carrelli portautensili
Pagina 6

NEW



Pinza chiave
Pagina 46

NEW



Serraggio controllato
Pagina 60



Arredamento da officina
Pagina 20



Banchi da lavoro
Pagina 22

NEW



Allestimenti per furgoni
Pagina 24

NEW



Assortimenti
Pagina 26



NEW

Valigie manutenzione
Pagina 30



NEW

Contenitori trasportabili
Pagina 32

NEW



Giraviti
Pagina 36



Inserti e chiavi maschio
Pagina 40



Pinze
Pagina 44



NEW

Chiavi di manovra
Pagina 47

NEW



Cricchetti e bussole
Pagina 52



Estrattori
Pagina 58



Forbici per elettricisti
Pagina 63



Elettrotecnica
Pagina 64

NEW

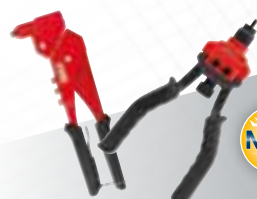

Rivettatrici
Pagina 66



Idraulica
Pagina 68

NEW



Manutenzione
Pagina 69



Illuminazione
Pagina 74

NEW



Autoriparazione
Pagina 76

NEW



Pneumatica e accessori
Pagina 90



CERCA GLI ICONIC PRODUCT:

i prodotti che fanno la differenza!



GIRAVITE ELETTRICO 324 XP

LA VELOCITÀ DELLA BATTERIA, LA SENSIBILITÀ DEL TUO POLSO.



**PORTAINSERTI
MAGNETICO**
con ghiera a
sgancio rapido.



IMPUGNATURA
ergonomica in gomma
resistente ad olii e
prodotti chimici.

IEC 60529



ILLUMINAZIONE
a 5 LED frontali con
autospegnimento a 10 secondi.



SISTEMA DI BLOCCAGGIO
automatico del mandrino per
applicare la forza a mano.

CE
EN 60529

CARATTERISTICHE TECNICHE

Vibrazioni (mm/s ²)	1,4
Potenza sonora dB(A)	54
Dimensioni (mm)	170x39
Peso (gr)	245



LITHIUM
Batteria 3.6V al litio
da 2 Ah.

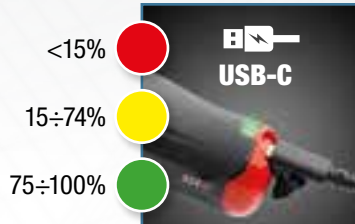

RICARICABILE
LED di indicazione
dello stato di carica.
Carica completa in 70
minuti (IN: 5V = 3A).

AVVITA LUI. STRINGI TU.

300
Giri/min



LA SUA VELOCITÀ
Avvita e svita velocemente
con i 300 giri/min del
motore elettrico.

LA TUA SENSIBILITÀ
Finisci il serraggio con la
sensibilità di un giravite
manuale.



0,9 Nm

10 Nm



16
PEZZI



324 XP/B16

Cod. U03240801

Giravite elettrico in astuccio con inserti

- Astuccio in nylon ad alta resistenza.
- Elastici portainseriti.
- Tasca interna per il cavo USB-C.
- Gancio per cintura.

~~€ 215,55~~ | **€ 99,00**

Nylon ad alta resistenza



Elastici portainseriti



Tasca interna per il cavo USB-C



Gancio per cintura

DESCRIZIONE	ARTICOLO/MISURA	PZ
Giravite elettrico	324 XP	1
Inserti ad intaglio lunghi (50mm)	664 0,6x4-0,8x5,5	2
Inserti esagonali lunghi (50 mm)	664 E 3-4-5-6	4
Inserti a croce PH lunghi (75 mm)	664 PH 1-2	2
Inserti a croce PZ lunghi (75 mm)	664 PZ 1-2	2
Inserti TORX lunghi (70 mm)	664 TX T10-T15-T20-T25-T30	5

SERRAGGIO RAPIDO DI PARTI DELICATE



INTERVENTI IN SPAZI RISTRETTI





CARRELLO 519 RACING

LA TUA POSTAZIONE DI LAVORO AL TOP.



**DUE RUOTE
CON FRENO**

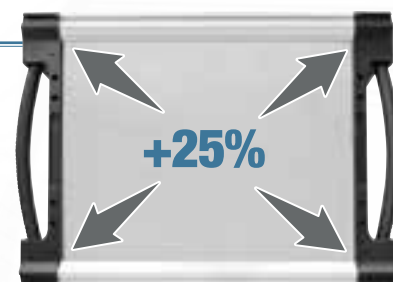

**NUOVO PIANO DI LAVORO AMPIO
CON DOPPIA MANIGLIA**



DOPPIO STRATO

Sopra: lastra in alluminio da 2 mm.
Sotto: piano in legno da 15 mm.



**PARAURTI IN GOMMA
SU TELAIO E CASSETTI**



**NUOVE MANIGLIE ERGONOMICHE
BASCULANTI IN ALLUMINIO**



**GUIDE CON SISTEMA DI
RICHIAMO A FINE CORSA**



519 ACT1

Cod. U05190301

Supporto laptop

€ 140,00 | **€ 98,00**



519 ACT2

Cod. U05190302

Porta flaconi
e porta rotolo

€ 150,00 | **€ 105,00**



YouTube



519 ACT3

Cod. U05190303

Barra blocca
cassetti

€ 156,00 | **€ 109,00**



519 ACT4

Cod. U05190304

Pannello per
moduli in spugna

€ 50,00 | **€ 35,00**



519 ACT5

Cod. U05190305

Porta documenti

€ 50,00 | **€ 35,00**



519 ACT6

Cod. U05190306

Piano in legno M3
(775 mm)

€ 180,00 | **€ 126,00**



519 ACT7

Cod. U05190307

Piano in legno M4
(965 mm)

€ 220,00 | **€ 154,00**



519 ACT8

Cod. U05190308

Piano in legno M5
(1155 mm)

€ 240,00 | **€ 168,00**



519 ACT9

Cod. U05190309

Piano in legno
porta morsa

€ 100,00 | **€ 70,00**



519 ACT10

Cod. U05190310

Ganci posteriori
porta oggetti

€ 22,00 | **€ 15,40**



519 ACT11

Cod. U05190311

Pannello forato con
mensola

€ 227,00 | **€ 159,00**



519 ACT12

Cod. U05190312

Pannello forato
doppio

€ 227,00 | **€ 159,00**



519 ACT13

Cod. U05190313

Pannello forato/
liscio con mensola

€ 250,00 | **€ 175,00**



519 ACT14

Cod. U05190314

Tripla mensola

€ 270,00 | **€ 189,00**



CREA IL CARRELLO ADATTO AL TUO LAVORO.

Il nuovo piano di lavoro integra un'innovativo sistema di binari che permettono di montare una nuova gamma di accessori specifici. Insieme all'utilizzo dei classici accessori laterali (pagina 13) puoi rendere il tuo carrello RACING una vera postazione di lavoro.

Carrelli portautensili



900 kg

NEW

8 CASSETTI

3 MODULI

79 kg | 814 mm | 1005 mm | 575 mm

519 RS8/3V
Cod. U05190508

RAL 3020

Carrello RACING (vuoto)

- Dimensioni interne:
 - 6 cassetti 570x420x60 mm.
 - 2 cassetti 570x420x130 mm.

~~€ 1.227,00~~ | **€ 859,00**



900 kg

NEW

7 CASSETTI

3 MODULI

77 kg | 814 mm | 1005 mm | 575 mm

519 RS7/3V
Cod. U05190507

RAL 3020

Carrello RACING (vuoto)

- Dimensioni interne:
 - 5 cassetti 570x420x60 mm.
 - 1 cassetto 570x420x130 mm.
 - 1 cassetto 570x420x200 mm.

~~€ 1.129,00~~ | **€ 790,00**



900 kg

NEW

6 CASSETTI

3 MODULI

75 kg | 814 mm | 1005 mm | 575 mm

519 RS6/3V
Cod. U05190506

RAL 3020

Carrello RACING (vuoto)

519 RS6/3NV
Cod. U05190516

RAL 9005

Carrello RACING (vuoto)

- Dimensioni interne:
 - 4 cassetti 570x420x60 mm.
 - 1 cassetto 570x420x130 mm.
 - 1 cassetto 570x420x270 mm.

~~€ 1.029,00~~ | **€ 720,00**



1000 kg

NEW

6 CASSETTI

4 MODULI

89 kg | 1004 mm | 1005 mm | 575 mm

519 RS6/4V
Cod. U05190546

RAL 3020

Carrello RACING (vuoto)

519 RS6/4NV
Cod. U05190566

RAL 9005

Carrello RACING (vuoto)

- Dimensioni interne:
 - 4 cassetti 760x420x60 mm.
 - 1 cassetto 760x420x130 mm.
 - 1 cassetto 760x420x270 mm.

~~€ 1.199,00~~ | **€ 839,00**



1100 kg

NEW

7 CASSETTI

5 MODULI

106 kg | 1194 mm | 1035 mm | 575 mm

519 RS7/5V
Cod. U05190556

RAL 3020

Carrello RACING (vuoto)

- Dimensioni interne:
 - 5 cassetti 950x420x60 mm.
 - 1 cassetto 950x420x130 mm.
 - 1 cassetto 950x420x200 mm.

~~€ 1.570,00~~ | **€ 1.099,00**



RISPARMIA IL TUO TEMPO

Tutti i carrelli a cassettera USAG sono subito pronti all'uso, perchè forniti con le ruote già montate alla struttura.





1100 kg

NEW

7 CASSETTI | 3 MODULI | 106 kg | 1194 mm | 1035 mm | 575 mm

519 RB07/3V

Cod. U05190097

RAL 3020

Carrello RACING con anta laterale (vuoto)

- Dimensioni interne:
 - 5 cassetti 570x420x60 mm.
 - 1 cassetto 570x420x130 mm.
 - 1 cassetto 570x420x200 mm.
- Vano laterale: 380x400x720 mm.

~~€ 1.570,00~~ | **€ 1.099,00**



NEW

1100 kg

6 CASSETTI | 3 MODULI | 128 kg | 1.212 mm | 1000 mm | 670 mm

519 RBU6/3V

Cod. U05190098

RAL 3020

Banco da lavoro mobile RACING (vuoto)

- Dimensioni interne:
 - 3 cassetti 570x420x60 mm.
 - 2 cassetti 570x420x130 mm.
 - 1 cassetto 570x420x200 mm.
- Vano laterale: 380x524x704 mm.



~~€ 1.964,00~~ | **€ 1.375,00**



NEW

519 ACT15

Cod. U05190315

Kit trasporto per cassetteria

- Include:
 - maniglione in acciaio.
 - 4 ruote (Ø 125 mm): due fisse e due pivotanti, di cui una con freno.

~~€ 100,00~~ | **€ 70,00**



4 CASSETTI

3 MODULI

NEW

45 kg | 814 mm | 500 mm | 575 mm

519 RSC4/3V

Cod. U05190534

RAL 3020

Cassetteria RACING (vuota)

- Dimensioni interne:
 - 3 cassetti: 570x420x60 mm.
 - 1 cassetto: 570x420x130 mm.

~~€ 788,00~~ | **€ 552,00**



4 CASSETTI

4 MODULI

NEW

51 kg | 1004 mm | 500 mm | 575 mm

519 RSC4/4V

Cod. U05190544

RAL 3020

Cassetteria RACING (vuota)

- Dimensioni interne:
 - 3 cassetti: 760x420x60 mm.
 - 1 cassetto: 760x420x130 mm.

~~€ 909,00~~ | **€ 636,00**



4 CASSETTI

5 MODULI

NEW

60 kg | 1194 mm | 500 mm | 575 mm

519 RSC4/5V

Cod. U05190554

RAL 3020

Cassetteria RACING (vuota)

- Dimensioni interne:
 - 3 cassetti: 950x420x60 mm.
 - 1 cassetto: 950x420x130 mm.

~~€ 1.024,00~~ | **€ 717,00**

NON TROVI IL
Vai subito su



6 CASSETTI **3** MODULI

RISPARMI
€ 270

Rispetto all'acquisto di carrello ed assortimento separati.



6 CASSETTI **3** MODULI

RISPARMI
€ 270

Rispetto all'acquisto di carrello ed assortimento separati.



519 RS6/3MM

Cod. U05190628

RAL 3020

519 RS6/3NMM

Cod. U05191628

RAL 9005

156
PEZZI

Carrello RACING con assortimento MANUTENZIONE - 4 cassette

~~€ 2.406,15~~ | **€ 1.199,00**



519 RS6/3MA

Cod. U05190627

RAL 3020

519 RS6/3NMA

Cod. U05191627

RAL 9005

155
PEZZI

Carrello RACING con assortimento AUTORIPARAZIONE - 3 cassette

~~€ 2.383,35~~ | **€ 1.199,00**



ASSORTIMENTO MANUTENZIONE



519 M 613AEA 519 M 613CEA 519 M 285A1



519 M 127C 519 M 150AX 519 MSK6



519 M 324H 519 M 324STX 519 MSK6+ 692 J32



519 M 990A5B 519 M 382 519 MSK6



519 M 285A1 519 M 324H 519 M 324STX



519 M 613AEA 519 M 612CLA

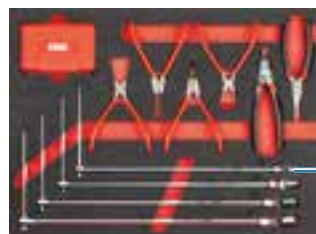

519 M 276C



CHIAVI A T SNODATE
8-10-13-17 mm

DESCRIZIONE	ART	PZ
Bussole esagonali, cricchetto (237 A), accessori 1/4 ed inserti	519 M 613AEA	46
Bussole esagonali, cricchetto (237 A) ed accessori 1/2	519 M 613CEA	23
Chiavi combinate (6-7-8-9-10-12-13-14-15-16-17-18-19-22-24 mm)	519 M 285A1	17
Pinze per anelli elastici interni ed esterni 15÷25 e 19÷60	519 M 127C	6
Pinza universale, pinza regolabile, tronchese, pinza becchi lunghi e pinza grip	519 M 150AX	5
Giraviti per viti ad intaglio ed a croce PHILLIPS	519 M 324H	7
Giraviti per viti TORX	519 M 324STX	8
Lime a taglio mezzodolce	519 M 990A5B	5
Martello per meccanici, mazzuola, cacciapine, scalpello e bulino	519 M 382F	7
Assortimento di inserti con cricchetto reversibile	692 J32	32

DESCRIZIONE	ART	PZ
Bussole esagonali, cricchetto (237 A), accessori 1/4 ed inserti	519 M 613AEA	46
Bussole esagonali lunghe e corte, cricchetto (237 A) ed accessori 1/2	519 M 612CLA	35
Chiavi combinate (6-7-8-9-10-12-13-14-15-16-17-18-19-22-24 mm)	519 M 285A1	17
Giraviti per viti ad intaglio ed a croce PHILLIPS	519 M 324H	7
Giraviti per viti TORX	519 M 324STX	8
Pinze per anelli elastici, pinza universale, pinza becchi lunghi, chiavi snodate con bussola esagonale (8-10-13-17 mm), assortimento di inserti con cricchetto	519 M 276C	42

TUO ASSORTIMENTO IDEALE? kitplanner.usag.it e realizzalo!



6
CASSETTI

4
MODULI

NEW

RISPARMI
€ 350

Rispetto all'acquisto di carrello ed assortimento separati.



6
CASSETTI

4
MODULI

NEW

RISPARMI
€ 350

Rispetto all'acquisto di carrello ed assortimento separati.

301
PEZZI

519 RS6/4MM

Cod. U05190632

RAL 3020

Carrello RACING con assortimento MANUTENZIONE - 4 cassette

~~€ 3.621,45~~ | **€ 1.799,00**



301
PEZZI

519 RS6/4NMM

Cod. U05191632

RAL 9005

Carrello RACING con assortimento MANUTENZIONE - 4 cassette

~~€ 3.621,45~~ | **€ 1.799,00**



ASSORTIMENTO MANUTENZIONE



DESCRIZIONE	ART	PZ
Bussole esagonali, cricchetto (237 A), accessori 1/4 ed inserti	519 M 613AEA	46
Bussole esagonali, cricchetto (237 A) ed accessori 3/8	519 M 613BEA	20
Bussole esagonali lunghe e corte, cricchetto (237 A) ed accessori 1/2	519 M 612CLA	35
Chiavi combinate a cricchetto reversibili (8-9-10-12-13-14-15-16-17-18-19 mm)	519 M 285 KA	12
Chiavi combinate (6-7-8-9-10-11-12-13-14-15-16-17-18-19-22-24 mm)	519 M 285A1	17
Chiavi combinate (27-29-30-32-34 mm)	519 M 285A2	5
Chiave a rullino rapida e corta, pinza autobloccante e forbice	519 M 294B	4
Giraviti per viti ad intaglio ed a croce PHILLIPS	519 M 324H	7

DESCRIZIONE	ART	PZ
Giraviti per viti TORX	519 M 324STX	8
Chiavi maschio esagonali con impugnatura (3-4-5-6-7-8-10 mm)	519 M 280HG	7
Cassetta inserti assortita e chiavi maschio esagonali / TORX	519 M 280N1	117
Pinze per anelli elastici interni ed esterni 15-25 e 19-60	519 M 127C	6
Pinza universale, pinza regolabile, tronchese, pinza becchi lunghi e pinza grip	519 M 150AX	5
Lime a taglio mezzodolce	519 M 990A5B	5
Martello per meccanici, mazzuola, cacciaspine, scalpello e bulino	519 M 382F	7

Vuoi solo l'assortimento? Vai a pagina 26



CARRELLO 516 START
ANCORA PIÙ RESISTENTE ED AFFIDABILE.

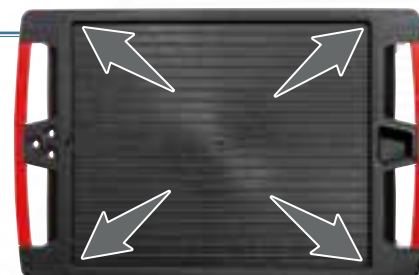

**NUOVO PIANO DI LAVORO
DA 460 X 560 mm
CON BORDI ANTICADUTA DA 15 mm**



**STABILE E CAPIENTE:
PROFONDITÀ TOTALE 515 mm**



**GUIDE RESISTENTI DA 35 mm
CON PORTATA FINO A 40 kg**



**NUOVE MANIGLIE IN ABS
RINFORZATE CON APERTURA
BASCULANTE**

GAMMA ACCESSORI PER CARRELLI 516 START



NEW

516 AC1

Cod. U05160301

Porta rotolo

€ 42,00 | **€ 29,40**



NEW

516 AC2

Cod. U05160302

Porta flaconi

€ 70,00 | **€ 49,00**



NEW

516 AC3

Cod. U05160303

Porta documenti

€ 50,00 | **€ 35,00**



NEW

516 AC4

Cod. U05160304

Porta rifiuti

€ 78,00 | **€ 54,50**



NEW

516 AC5

Cod. U05160305

Armadio con serratura

€ 227,00 | **€ 159,00**



NEW

516 AC6

Cod. U05160306

Ripiano pieghevole

€ 141,00 | **€ 98,50**



NEW

516 AC7

Cod. U05160307

Supporto
per avvitatori

€ 93,00 | **€ 65,00**



NEW

516 AC8

Cod. U05160308

Porta flaconi con
presa schuko e USB

• Lunghezza cavo 1,8 m.
€ 100,00 | **€ 70,00**



NEW

516 AC9

Cod. U05160309

Piano in legno
da 15 mm

€ 70,00 | **€ 49,00**



COMPLETA IL TUO CARRELLO E RENDILO PERFETTO

Tutti i carrelli della gamma 516 START possono essere completati con i nuovi accessori laterali. Si agganciano facilmente, aggiungendo funzioni utili alle diverse destinazioni d'uso. La gamma di accessori 516 START è compatibile anche con tutti i modelli della gamma 519 RACING e con i moduli base della linea arredamento 516 START.

Carrelli portautensili



800 kg

NEW

5 CASSETTI

3 MODULI



516 ST5V

Cod. U05160105

RAL 3020

Carrello START (vuoto)

• Dimensioni interne:

- 2 cassetti 570x420x60 mm.
- 2 cassetti 570x420x130 mm.
- 1 cassetto 570x420x270 mm.

~~€ 542,00~~ | **€ 379,00**



800 kg

NEW

6 CASSETTI

3 MODULI

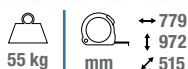

516 ST6V

Cod. U05160106

RAL 3020

Carrello START (vuoto)

516 ST6NV

Cod. U05160116

RAL 9005

Carrello START (vuoto)

• Dimensioni interne:

- 3 cassetti 570x420x60 mm.
- 2 cassetti 570x420x130 mm.
- 1 cassetto 570x420x200 mm.

~~€ 613,00~~ | **€ 439,00**



800 kg

NEW

7 CASSETTI

3 MODULI



516 ST7V

Cod. U05160107

RAL 3020

Carrello START (vuoto)

516 ST7NV

Cod. U05160117

RAL 9005

Carrello START (vuoto)

• Dimensioni interne:

- 5 cassetti 570x420x60 mm.
- 1 cassetto 570x420x130 mm.
- 1 cassetto 570x420x200 mm.

~~€ 670,00~~ | **€ 469,00**



800 kg

NEW

6 CASSETTI

4 MODULI



516 STXL6V

Cod. U05160146

RAL 3020

Carrello START (vuoto)

516 STXL6NV

Cod. U05160156

RAL 9005

Carrello START (vuoto)

• Dimensioni interne:

- 3 cassetti 760x420x60 mm.
- 2 cassetti 760x420x130 mm.
- 1 cassetto 760x420x200 mm.

~~€ 742,00~~ | **€ 519,00**



800 kg

Antiribaltamento



NEW

6 CASSETTI

3 MODULI



516 STS6NV

Cod. U05160136

RAL 9005

Carrello START (vuoto)

• Dimensioni interne:

- 3 cassetti 570x420x60 mm.
- 2 cassetti 570x420x130 mm.
- 1 cassetto 570x420x200 mm.

~~€ 728,00~~ | **€ 509,00**



RISPARMIA IL TUO TEMPO

Tutti i carrelli a cassetteria USAG sono subito pronti all'uso, perchè forniti con le ruote già montate alla struttura.



Doppio cassetto



30 kg | mm | 779
972
515

2 CASSETTI | 3 MODULI

3 RIPIANI

COMPATIBILE CON ACCESSORI 516



516 SU2V

Cod. U05160002

RAL 3020

Carrello START multiuso con cassetti

- Piano di lavoro in ABS ad alta resistenza con doppia maniglia.
- Ripiani con bordo anticaduta e copertura in plastica antiolio.
- Fornito smontato.
- Dimensioni cassetti:
 - 2 cassetti 570x420x60 mm.

~~€ 385,00~~ | **€ 289,00**

Versione extralarge



22 kg | mm | 969
972
515

3 RIPIANI

COMPATIBILE CON ACCESSORI 516



516 SUXLV

Cod. U05160003

RAL 3020

Carrello START multiuso XL

- Piano di lavoro in ABS ad alta resistenza con doppia maniglia.
- Ripiani con bordo anticaduta e copertura in plastica antiolio.
- Fornito smontato.

~~€ 285,00~~ | **€ 215,00**



18 kg | mm | 750
950
450

3 RIPIANI

4 CASSETTI

3 MODULI



34 kg | mm | 779
467
515



504 S

Cod. U05040003

RAL 3020

Carrello multiuso

- Ripiani protetti con materiale plastico ad alta resistenza.
- Maniglia in acciaio per una maggiore manovrabilità.
- Due ruote pivotanti (Ø 100 mm) e due ruote fisse (Ø 100 mm).
- Fornito smontato.

~~€ 190,00~~ | **€ 143,00**

516 STC4V

Cod. U05160104

RAL 3020

Cassettiera START (vuota)

- Dimensioni interne:
 - 3 cassetti: 570x420x60 mm.
 - 1 cassetto: 570x420x130 mm.

~~€ 429,00~~ | **€ 299,00**

516 AC10

Cod. U05160310

Kit trasporto per cassettera

- Include:
 - maniglione in acciaio.
 - 4 ruote (Ø 125 mm): due fisse e due pivotanti, di cui una con freno.

~~€ 100,00~~ | **€ 70,00**

NON TROVI IL
Vai subito su



6
CASSETTI

3
MODULI

RISPARMI
€ 120

Rispetto all'acquisto di carrello ed assortimento separati.



6
CASSETTI

3
MODULI

RISPARMI
€ 120

Rispetto all'acquisto di carrello ed assortimento separati.



516 ST6PM
Cod. U05160630

RAL 3020

157
PEZZI

516 ST6NPM
Cod. U05161630

RAL 9005

Carrello START con assortimento MANUTENZIONE - 4 cassette

~~€ 1.767,95~~ | **€ 899,00**



516 ST6PA
Cod. U05160629

RAL 3020

142
PEZZI

516 ST6NPA
Cod. U05161629

RAL 9005

Carrello START con assortimento AUTORIPARAZIONE - 2 cassette

~~€ 1.680,60~~ | **€ 899,00**



ASSORTIMENTO MANUTENZIONE

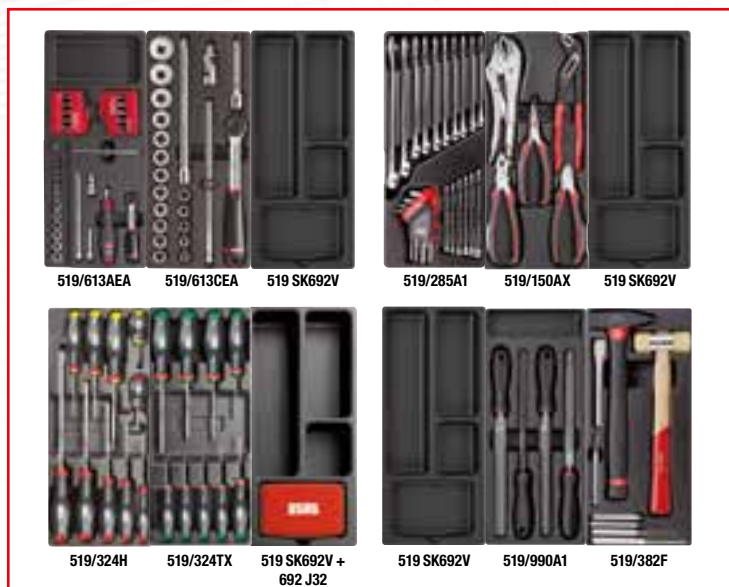

ASSORTIMENTO AUTORIPARAZIONE

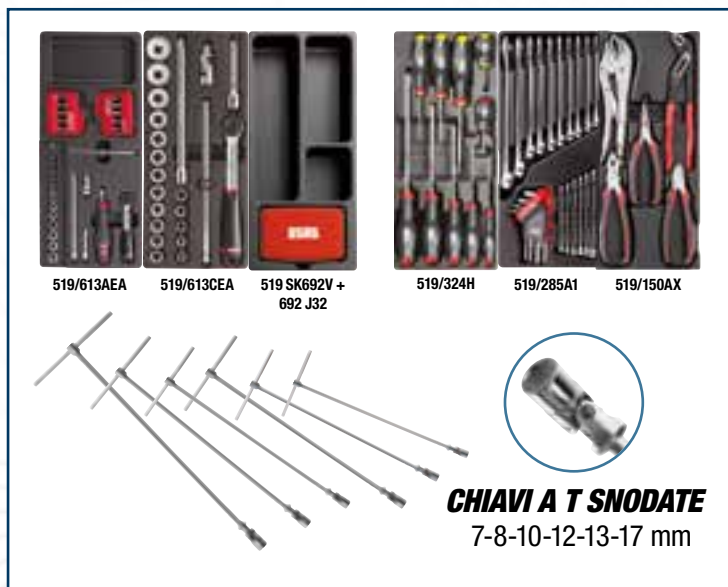

DESCRIZIONE	ART	PZ
Bussole esagonali, cricchetto (237 A), accessori 1/4 ed inserti	519/613AEA	42
Bussole esagonali, cricchetto (237 A) ed accessori 1/2	519/613CEA	22
Chiavi combinate (6÷24 mm) + chiavi maschio esagonali (1,5÷10 mm)	519/285A1	25
Pinza universale, pinza regolabile, tronchese, pinza becchi lunghi e pinza grip	519/150AX	5
Giraviti per viti ad intaglio ed a croce PHILLIPS	519/324H	10
Giraviti per viti TORX	519/324TX	9
Lime a taglio mezzodolce	519/990A1	4
Martello per meccanici, mazzuola, cacciapine, scalpello e bulino	519/382F	8
Assortimento di inserti con cricchetto reversibile	692 J32	32

DESCRIZIONE	ART	PZ
Bussole esagonali, cricchetto (237 A), accessori 1/4 ed inserti	519/613AEA	42
Bussole esagonali, cricchetto (237 A) ed accessori 1/2	519/613CEA	22
Giraviti per viti ad intaglio ed a croce PHILLIPS	519/324H	10
Chiavi combinate (6÷24 mm) + chiavi maschio esagonali (1,5÷10 mm)	519/285A1	25
Pinza universale, pinza regolabile, tronchese, pinza becchi lunghi e pinza grip	519/150AX	5
Chiavi a T snodate con bocca esagonale (7-8-10-12-13-17 mm)	276 CE	6
Assortimento di inserti con cricchetto reversibile	692 J32	32

CHIAVI A T SNODATE
7-8-10-12-13-17 mm

Vuoi solo l'assortimento? Vai a pagina 27

TUO ASSORTIMENTO IDEALE?

kitplanner.usag.it e realizzalo!



6 CASSETTI 3 MODULI

RISPARMI
€ 180

Rispetto all'acquisto di carrello ed assortimento separati.



6 CASSETTI 3 MODULI

RISPARMI
€ 180

Rispetto all'acquisto di carrello ed assortimento separati.



516 ST6MM
Cod. U05160628

RAL 3020

156 PEZZI

516 ST6NMM
Cod. U05161628

RAL 9005

Carrello START con assortimento MANUTENZIONE - 4 cassette

~~€ 1.990,15~~ | **€ 999,00**



516 ST6MA
Cod. U05160627

RAL 3020

155 PEZZI

516 ST6NMA
Cod. U05161627

RAL 9005

Carrello START con assortimento AUTORIPARAZIONE - 3 cassette

~~€ 1.967,35~~ | **€ 999,00**



ASSORTIMENTO MANUTENZIONE



519 M 613AEA 519 M 613CEA 519 M 285A1

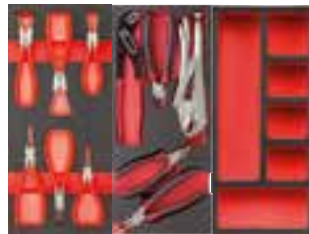

519 M 127C 519 M 150AX 519 MSK6



519 M 324H 519 M 324STX 519 MSK6+ 692 J32



519 M 990A5B 519 M 382 519 MSK6

ASSORTIMENTO AUTORIPARAZIONE



519 M 285A1 519 M 324H 519 M 324STX



519 M 613AEA 519 M 612CLA



519 M 276C



CHIAVI A T SNODATE
8-10-13-17 mm

DESCRIZIONE	ART	PZ
Bussole esagonali, cricchetto (237 A), accessori 1/4 ed inserti	519 M 613AEA	46
Bussole esagonali, cricchetto (237 A) ed accessori 1/2	519 M 613CEA	23
Chiavi combinate (6-7-8-9-10-12-13-14-15-16-17-18-19-22-24 mm)	519 M 285A1	17
Pinze per anelli elastici interni ed esterni 15÷25 e 19÷60	519 M 127C	6
Pinza universale, pinza regolabile, tronchese, pinza becchi lunghi e pinza grip	519 M 150AX	5
Giraviti per viti ad intaglio ed a croce PHILLIPS	519 M 324H	7
Giraviti per viti TORX	519 M 324STX	8
Lime a taglio mezzodolce	519 M 990A5B	5
Martello per meccanici, mazzuola, cacciaspine, scalpello e bulino	519 M 382F	7
Assortimento di inserti con cricchetto reversibile	692 J32	32

DESCRIZIONE	ART	PZ
Bussole esagonali, cricchetto (237 A), accessori 1/4 ed inserti	519 M 613AEA	46
Bussole esagonali lunghe e corte, cricchetto (237 A) ed accessori 1/2	519 M 612CLA	35
Chiavi combinate (6-7-8-9-10-12-13-14-15-16-17-18-19-22-24 mm)	519 M 285A1	17
Giraviti per viti ad intaglio ed a croce PHILLIPS	519 M 324H	7
Giraviti per viti TORX	519 M 324STX	8
Pinze per anelli elastici, pinza universale, pinza becchi lunghi, chiavi snodate con bussola esagonale (8-10-13-17 mm), assortimento di inserti con cricchetto	519 M 276C	42

Vuoi solo l'assortimento? Vai a pagina 26



NON TROVI IL
Vai subito su



6
CASSETTI

4
MODULI

NEW

RISPARMI
€ 230

Rispetto all'acquisto di carrello ed assortimento separati.



6
CASSETTI

4
MODULI

NEW

RISPARMI
€ 230

Rispetto all'acquisto di carrello ed assortimento separati.

301
PEZZI

516 STXL6MM

Cod. U05160632

RAL 3020

Carrello START con assortimento MANUTENZIONE - 4 cassette

~~€ 3.164,45~~ | **€ 1.599,00**



301
PEZZI

516 STXL6NMM

Cod. U05161632

RAL 9005

Carrello START con assortimento MANUTENZIONE - 4 cassette

~~€ 3.164,45~~ | **€ 1.599,00**



ASSORTIMENTO MANUTENZIONE



519 M 612CLA

519 M 613BEA

519 M 613AEA

519 M 285KA

519 M 285A1

519 M 285A2

519 M 294B

519 M 324H

519 M 324STX

519 M 280HG

519 M 280N1

519 M 127C

519 M 150AX

519 M 382F

519 M 990A5MD

DESCRIZIONE	ART	PZ
Bussole esagonali, cricchetto (237 A), accessori 1/4 ed inserti	519 M 613AEA	46
Bussole esagonali, cricchetto (237 A) ed accessori 3/8	519 M 613BEA	20
Bussole esagonali lunghe e corte, cricchetto (237 A) ed accessori 1/2	519 M 612CLA	35
Chiavi combinate a cricchetto reversibili (8-9-10-12-13-14-15-16-17-18-19 mm)	519 M 285 KA	12
Chiavi combinate (6-7-8-9-10-12-13-14-15-16-17-18-19-22-24 mm)	519 M 285A1	17
Chiavi combinate (27-29-30-32-34 mm)	519 M 285A2	5
Chiave a rullino rapida e corta, pinza autobloccante e forbice	519 M 294B	4
Giraviti per viti ad intaglio ed a croce PHILLIPS	519 M 324H	7

DESCRIZIONE	ART	PZ
Giraviti per viti TORX	519 M 324STX	8
Chiavi maschio esagonali con impugnatura (3-4-5-6-7-8-10 mm)	519 M 280HG	7
Cassetta inserti assortita e chiavi maschio esagonali / TORX	519 M 280N1	117
Pinze per anelli elastici interni ed esterni 15÷25 e 19÷60	519 M 127C	6
Pinza universale, pinza regolabile, tronchese, pinza becchi lunghi e pinza grip	519 M 150AX	5
Lime a taglio mezzodolce	519 M 990A5B	5
Martello per meccanici, mazzuola, cacciaspine, scalpello e bulino	519 M 382F	7

Vuoi solo l'assortimento? Vai a pagina 26

TUO ASSORTIMENTO IDEALE?

kitplanner.usag.it e realizzalo!



6 CASSETTI **3 MODULI** **18V XR DCD796**

Incluso trapano avvitatore



6 CASSETTI **3 MODULI** **18V XR DCF894**

Incluso avvitatore ad impulsi



516 ST6UD-796
Cod. U05162796W

RAL 3020



516 ST6UD-894
Cod. U05162894W

RAL 3020

INS EME UN CI

516 ST6NUD-796
Cod. U05163796W

RAL 9005

Carrello START con assortimento MANUTENZIONE - 4 cassette

INS EME UN CI

516 ST6NUD-894
Cod. U05163894W

RAL 9005

Carrello START con assortimento AUTORIPARAZIONE - 4 cassette

113 PEZZI



€ 2.370,00 | **€ 1.199,00**

121 PEZZI



€ 2.585,00 | **€ 1.199,00**

ASSORTIMENTO MANUTENZIONE



519 M 613AEA 519 M 613CEA 519 MSK6



519 M 324H 519 M 324STX 519 MSK6



519 M 285A1 519 M 150AX 519 MSK6



519 M 990A5MD

Alloggiamento libero per 3^a batteria



2 batterie incluse



519 M 613AEA 519 M 613CEA 519 MSK6



519 M 324H 519 M 324STX 519 MSK6



519 M 285A1 519 M 150AX 519 MSK6

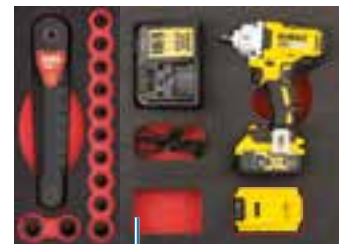

519 M 236K

Alloggiamento libero per 3^a batteria



2 batterie incluse

DESCRIZIONE	ART	PZ
Bussole esagonali, cricchetto (237 A 1/4"), accessori 1/4" ed inserti	519 M 613AEA	46
Bussole esagonali, cricchetto (237 A 1/2") e accessori 1/2"	519 M 613CEA	23
Chiavi combinate (6-7-8-9-10-11-12-13-14-15-16-17-18-19-22-24 mm)	519 M 285A1	17
Pinza universale, pinza regolabile, tronchese, pinza becchi lunghissimi, pinza grip	519 M 150AX	5
Giraviti a taglio e croce PH	519 M 324H	7
Giraviti TORX® Tamper Resistant (T10-T15-T20-T25-T30-T40)	519 M 324STX	8
Lime a taglio mezzodolce	519 M 990A5B	5
Caricabatterie universale XR Litio	DCB115	1
Trapano avvitatore con percussione	DCD796	1

DESCRIZIONE	ART	PZ
Bussole esagonali, cricchetto (237 A 1/4"), accessori 1/4" ed inserti	519 M 613AEA	46
Bussole esagonali, cricchetto (237 A 1/2") e accessori 1/2"	519 M 613CEA	23
Chiavi combinate (6-7-8-9-10-11-12-13-14-15-16-17-18-19-22-24 mm)	519 M 285A1	17
Pinza universale, pinza regolabile, tronchese, pinza becchi lunghissimi, pinza grip	519 M 150AX	5
Giraviti a taglio e croce PH	519 M 324H	7
Giraviti TORX® Tamper Resistant (T10-T15-T20-T25-T30-T40)	519 M 324STX	8
Cassetta inserti assortita e chiavi maschio esagonali - TORX®	519 M 236K	13
Caricabatterie universale XR Litio	DCB115	1
Avvitatore ad impulsi 1/2" con batteria	DCF894	1



VUOI CREARE LA TUA

Vai subito su



YouTube



ACCIAIO

516 SA/CA1

Cod. U05160235

135 kg | 1.450 mm | 2.000 mm | 650

Pianale in acciaio
1.450 mm
516 AC/1

Arredamento per officina - pianale in acciaio

• Fornita con kit base di 30 ganci 516 SA/K1.

~~€ 1.874,60~~ | **€ 1.299,00**

LEGNO

516 SA/C1

Cod. U05160231

127 kg | 1.450 mm | 2.000 mm | 650

Pianale in legno
1.450 mm
516 SAL/1

Arredamento per officina - pianale in legno

• Fornita con kit base di 30 ganci 516 SA/K1.

~~€ 1.874,60~~ | **€ 1.299,00**



Include: ganci e lampade LED

POSSIBILITÀ DI INVERTIRE IL SENSO DI APERTURA DELL'ANTA



ACCIAIO

516 SA/CA2

Cod. U05160236

198 kg | 1.950 mm | 2.000 mm | 650

Pianale in acciaio
1.450 mm
516 AC/1

Arredamento per officina - pianale in acciaio

• Fornita con kit base di 30 ganci 516 SA/K1.

~~€ 2.886,60~~ | **€ 1.999,00**

LEGNO

516 SA/C2

Cod. U05160232

190 kg | 1.950 mm | 2.000 mm | 650

Pianale in legno
1.450 mm
516 SAL/1

Arredamento per officina - pianale in legno

• Fornita con kit base di 30 ganci 516 SA/K1.

~~€ 2.886,60~~ | **€ 1.999,00**



Include: ganci, lampade LED e presa multipla

DESCRIZIONE	ART	PZ
Mobile fisso con 6 cassetti	516 SA/1	1
Mobile fisso con 2 ante	516 SA/2	1
Armadio a 1 anta	516 SA/3	1
Pensile con anta basculante	516 SA/4	2
Pannello forato portautensili	516 SA/5	3
Pannello forato portautensili con 6 prese SCHUKO	516 SA/6	1
Rialzo per mobili	516 SA/11	3
Lampada a LED	516 SA/12	2
Kit di montaggio	516 SA/14	2
Kit di 30 ganci per pannelli	516 SA/K1	1

POSTAZIONE SU MISURA? start516.usag.it e realizzala!

**POSSIBILITÀ DI INVERTIRE IL SENSO
DI APERTURA DELL'ANTA**



**Include: ganci, lampade LED
e presa multipla**

ACCIAIO

516 SA/CA3

Cod. U05160237

289 kg | mm | ↔ 2.675
↓ 2.000
↙ 650

Pianale in acciaio
2.175 mm
516 AC/2

Arredamento per officina - pianale in acciaio

• Fornita con kit base di 30 ganci 516 SA/K1.

~~€ 3.929,80~~ | **€ 2.699,00**

LEGNO

516 SA/C3

Cod. U05160233

278 kg | mm | ↔ 2.675
↓ 2.000
↙ 650

Pianale in legno
2.175 mm
516 SAL/2

Arredamento per officina - pianale in legno

• Fornita con kit base di 30 ganci 516 SA/K1.

~~€ 3.929,80~~ | **€ 2.699,00**

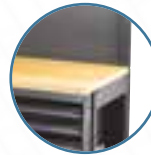

DESCRIZIONE	ART	PZ
Mobile fisso con 6 cassetti	516 SA/1	1
Mobile fisso con 2 ante	516 SA/2	1
Armadio a 1 anta	516 SA/3	1
Pensile con anta basculante	516 SA/4	3
Pannello forato portautensili	516 SA/5	5
Pannello forato portautensili con 6 prese SCHUKO	516 SA/6	1
Rialzo per mobili	516 SA/11	3
Lampada a LED	516 SA/12	2
Kit di montaggio	516 SA/14	3
Kit di 30 ganci per pannelli	516 SA/K1	1
Carrello - 6 cassetti	516 SA/16	1



**Include: ganci, lampade LED
e presa multipla**

ACCIAIO

516 SA/CA4

Cod. U05160238

160 kg | mm | ↔ 2.175
↓ 2.000
↙ 650

Pianale in acciaio
2.175 mm
516 AC/2

Arredamento per officina - pianale in acciaio

• Fornita con kit base di 30 ganci 516 SA/K1.

~~€ 2.152,30~~ | **€ 1.489,00**

LEGNO

516 SA/C4

Cod. U05160234

147 kg | mm | ↔ 2.175
↓ 2.000
↙ 650

Pianale in legno
2.175 mm
516 SAL/2

Arredamento per officina - pianale in legno

• Fornita con kit base di 30 ganci 516 SA/K1.

~~€ 2.152,30~~ | **€ 1.489,00**

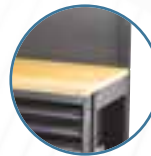

DESCRIZIONE	ART	PZ
Mobile fisso con 6 cassetti	516 SA/1	1
Mobile fisso con 2 ante	516 SA/2	1
Pannello forato portautensili	516 SA/5	8
Pannello forato portautensili con 6 prese SCHUKO	516 SA/6	1
Rialzo per mobili	516 SA/11	2
Lampada a LED	516 SA/12	2
Ripiano metallico	516 SA/13	3
Kit di montaggio	516 SA/14	3
Kit di 30 ganci per pannelli	516 SA/K1	1

1000 kg



ACCIAIO

6
CASSETTI

3
MODULI

RAL 3020

516 SPC2
Cod. U05160021

102 kg | mm | → 2.000
↓ 850
↙ 700

Banco da lavoro START con piano in acciaio

- Dimensioni interne cassetti:
 - 3 cassetti 570x420x60 mm.
 - 2 cassetti 570x420x130 mm.
 - 1 cassetto 570x420x200 mm.

~~€ 1.177,00~~ | **€ 824,00**



RAL 9004

516 SPCN2
Cod. U05160023

Banco da lavoro START con piano in acciaio

~~€ 1.177,00~~ | **€ 824,00**

2000 mm

Piano in acciaio zincato

Trattato anticorrosione e con bordi anticaduta da 37 mm.

1000 kg



LEGNO

6
CASSETTI

3
MODULI

RAL 3020

516 SPC1
Cod. U05160020

115 kg | mm | → 2.000
↓ 850
↙ 700

Banco da lavoro START con piano in legno

- Dimensioni interne cassetti:
 - 3 cassetti 570x420x60 mm.
 - 2 cassetti 570x420x130 mm.
 - 1 cassetto 570x420x200 mm.

~~€ 1.177,00~~ | **€ 824,00**



RAL 9004

516 SPCN1
Cod. U05160022

Banco da lavoro START con piano in legno

~~€ 1.177,00~~ | **€ 824,00**

2000 mm

Piano in faggio multistrato

Lo spessore di 40 mm garantisce il top della resistenza.



506 BA

RAL 9004

ACCIAIO

Banco da lavoro con piano in acciaio

- Piano in lamiera d'acciaio zincata (spessore 2,5 mm) con bordi anticaduta altezza 37 mm.
- Ripiano inferiore d'appoggio incluso.
- Predisposizione per il fissaggio al pavimento.
- Struttura in lamiera d'acciaio verniciata, colore nero RAL 9004.
- 4 montanti per le lunghezze 1 m e 1,5 m.
- 6 montanti per la lunghezza 2 m.
- Possibilità di montare il cassetto 506 U130.

CODICE	L (mm)	P (mm)	H (mm)	📦	
U05060014	1.000	700	850	50 kg	€ 259,00 € 194,00
U05060015	1.500	700	850	63 kg	€ 367,00 € 275,00
U05060016	2.000	700	850	85 kg	€ 459,00 € 344,00



506 BL

RAL 9004

LEGNO

Banco da lavoro con piano in legno

- Piano in legno multistrato (spessore 40 mm) integrato nella struttura.
- Ripiano inferiore d'appoggio incluso.
- Predisposizione per il fissaggio al pavimento.
- Struttura in lamiera d'acciaio verniciata, colore nero RAL 9004.
- 4 montanti per le lunghezze 1 m e 1,5 m.
- 6 montanti per la lunghezza 2 m.
- Possibilità di montare il cassetto 506 U130.

CODICE	L (mm)	P (mm)	H (mm)	📦	
U05060004	1.000	700	850	55 kg	€ 371,00 € 278,00
U05060005	1.500	700	850	69 kg	€ 501,00 € 376,00
U05060006	2.000	700	850	93 kg	€ 601,00 € 451,00



506 BAG/2000

Cod. U05060034

RAL 9004

ACCIAIO

Banco da lavoro con piano in acciaio

- 2 cassetti con serratura montati su guide telescopiche, colore rosso RAL 3020.
- Dimensione interna cassetti: 570x420x175 mm.

~~€ 695,00~~ | € 521,00



506 BLC/2000

Cod. U05060024

RAL 9004

LEGNO

Banco da lavoro con piano in legno

- 2 cassetti con serratura montati su guide telescopiche, colore rosso RAL 3020.
- Dimensione interna cassetti: 570x420x175 mm.

~~€ 852,00~~ | € 639,00



2 CASSETTI

2 CASSETTI

SISTEMA MODULARE PER

GRAZIE AL CONFIGURATORE ALLESTISCI IL TUO FURGONE COME PIACE A TE!

MATRIX

Vai su matrix.usag.it
o inquadra il QR code



1

FACILE ED INTUITIVO

Posiziona i moduli come piace a te all'interno del tuo furgone.

2

FUNZIONA ONLINE

Non richiede nessuna installazione ed è compatibile con i browser più diffusi.

3

PROGETTO IN UN CLIC

Salva il tuo progetto ed esportalo in PDF o Excel per chiedere un preventivo al tuo Rivenditore.



SE LO DESIDERI POSSIAMO VERIFICARE GRATUITAMENTE IL TUO PROGETTO:

Inviaci i files excel, pdf o .mtx salvati tramite il configuratore, al nostro indirizzo matrix@mygts.net.



ALLESTIMENTO FURGONI



LATO SINISTRO



96 kg | mm | 1.238 mm | 1.146 mm | 375 mm



5006 EF2

Cod. U50060035

Composizione:

DESCRIZIONE	CODICE	PZ.
Cassetteria 5000 E5	U50000105	1
Cassetteria 5000 CE3	U50000052	1
Base passaruota 5002 B3	U50020010	1
Porta-flaconi 5002 SA5	U50020067	1
Coppia montanti 5003 MF1	U50030052	1
Ripiano porta vaschette 5003 A2/7	U50030074	1
Sistema di fissaggio 5002 S5	U50020048	2

~~€ 1.750,50~~ | **€ 1.225,00**

Inquadra il QR code per verificare i modelli di furgoni compatibili.

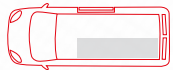

LATO SINISTRO



43 kg | mm | 990 mm | 1.014 mm | 375 mm



5006 EF6

Cod. U50060040

NEW

Composizione:

DESCRIZIONE	CODICE	PZ.
Cassetteria per valigette 5000 AD2	U50000004	1
Cassetteria 5000 C3	U50000042	1
Base passaruota 5002 B2N	U50020009	1
Ripiano 5002 R2	U50020031	1
Porta flaconi 5002 SA5	U50020067	1
Sistema di fissaggio 5002 S5	U50020048	1

~~€ 1.190,60~~ | **€ 833,00**

Inquadra il QR code per verificare i modelli di furgoni compatibili.



NUOVO MODULO PER VALIGETTE TSTAK

Permette di alloggiare fino a due valigette portautensili, organizer o elettroutensili. La barre di chiusura centrale garantisce sicurezza durante il trasporto.

TSTAK™



MODULI IN SPUGNA BICOLORE

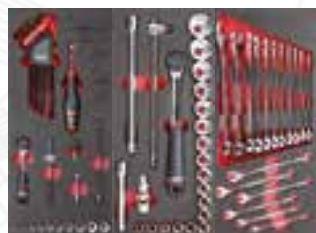

519 M 613AEA 519 M 613CEA 519 M 285A1



519 M 127C 519 M 150AX 519 MSK6



519 M 324H 519 M 324STX 519 MSK6+692 J32



519 M 990A5B 519 M 382 519 MSK6



519 M 285A1 519 M 324H 519 M 324STX



519 M 613AEA 519 M 612CLA



519 M 276C



CHIAVI A T SNODATE
8-10-13-17 mm

495 MB

Cod. U04950628

156
PEZZI



NEW

Assortimento MANUTENZIONE - 4 cassette

DESCRIZIONE	ART	PZ
Bussole esagonali, cricchetto (237 A), accessori 1/4 ed inserti	519 M 613AEA	46
Bussole esagonali, cricchetto (237 A) ed accessori 1/2	519 M 613CEA	23
Chiavi combinate (6-7-8-9-10-11-12-13-14-15-16-17-18-19-22-24 mm)	519 M 285A1	17
Pinze per anelli elastici interni ed esterni 15÷25 e 19÷60	519 M 127C	6
Pinza universale, pinza regolabile, tronchese, pinza becchi lunghi e pinza grip	519 M 150AX	5
Giraviti per viti ad intaglio ed a croce PHILLIPS	519 M 324H	7
Giraviti per viti TORX	519 M 324STX	8
Lime a taglio mezzodolce	519 M 990A5B	5
Martello per meccanici, mazzuola, cacciaspine, scalpello e bulino	519 M 382F	7
Assortimento di inserti con cricchetto reversibile	692 J32	32

~~€ 1.377,15~~ | **€ 750,00**

495 MAA

Cod. U04950627

155
PEZZI



NEW

Assortimento AUTORIPARAZIONE - 3 cassette

DESCRIZIONE	ART	PZ
Bussole esagonali, cricchetto (237 A), accessori 1/4 ed inserti	519 M 613AEA	46
Bussole esagonali lunghe e corte, cricchetto (237 A) ed accessori 1/2	519 M 612CLA	35
Chiavi combinate (6-7-8-9-10-11-12-13-14-15-16-17-18-19-22-24 mm)	519 M 285A1	17
Giraviti per viti ad intaglio ed a croce PHILLIPS	519 M 324H	7
Giraviti per viti TORX	519 M 324STX	8
Pinze per anelli elastici, pinza universale, pinza becchi lunghi, chiavi snodate con bussola esagonale (8-10-13-17 mm), assortimento di inserti con cricchetto	519 M 276C	42

~~€ 1.354,35~~ | **€ 750,00**



519 M 612CLA 519 M 613BEA 519 M 613AEA



519 M 285KA 519 M 285A1 519 M 285A2 519 M 294B

301
PEZZI



495 MC

Cod. U04950632

**Assortimento MANUTENZIONE
4 cassette**

~~€ 2.422,45~~

€ 1.310,00



519 M 324H 519 M 324STX 519 M 280HG 519 M 280N1



519 M 127C 519 M 150AX 519 M 382F 519 M 990A5MD



MODULI IN PLASTICA



519/613AEA 519/613CEA 519 SK692V



519/285A1 519/150AX 519 SK692V



519/324H 519/324TX 519 SK692V + 692 J32



519 SK692V 519/990A1 519/382F

495 PM

Cod. U04950630

157
PEZZI



Assortimento MANUTENZIONE - 4 cassette

DESCRIZIONE	ART	PZ
Bussole esagonali, cricchetto (237 A), accessori 1/4 ed inserti	519/613AEA	42
Bussole esagonali, cricchetto (237 A) ed accessori 1/2	519/613CEA	22
Chiavi combinate (6÷24 mm) + chiavi maschio esagonali (1,5÷10 mm)	519/285A1	25
Pinza universale, pinza regolabile, tronchese, pinza becchi lunghi e pinza grip	519/150AX	5
Giraviti per viti ad intaglio ed a croce PHILLIPS	519/324H	10
Giraviti per viti TORX	519/324TX	9
Lime a taglio mezzodolce	519/990A1	4
Martello per meccanici, mazzuola, cacciaspine, scalpello e bulino	519/382F	8
Assortimento di inserti con cricchetto reversibile	692 J32	32

~~€ 1.154,95~~ | € 590,00



519/613AEA 519/613CEA 519 SK692V + 692 J32



519/324H 519/285A1 519/150AX

495 PA

Cod. U04950629

142
PEZZI



Assortimento AUTORIPARAZIONE - 2 cassette

DESCRIZIONE	ART	PZ
Bussole esagonali, cricchetto (237 A), accessori 1/4 ed inserti	519/613AEA	42
Bussole esagonali, cricchetto (237 A) ed accessori 1/2	519/613CEA	22
Giraviti per viti ad intaglio ed a croce PHILLIPS	519/324H	10
Chiavi combinate (6÷24 mm) + chiavi maschio esagonali (1,5÷10 mm)	519/285A1	25
Pinza universale, pinza regolabile, tronchese, pinza becchi lunghi e pinza grip	519/150AX	5
Chiavi a T snodate con bocca esagonale (7-8-10-12-13-17 mm)	276 CE	6
Assortimento di inserti con cricchetto reversibile	692 J32	32

~~€ 1.067,60~~ | € 590,00



CHIAVI A T SNODATE
7-8-10-12-13-17 mm

DESCRIZIONE	ART	PZ
Bussole esagonali, cricchetto (237 A), accessori 1/4 ed inserti	519 M 613AEA	46
Bussole esagonali, cricchetto (237 A) ed accessori 3/8	519 M 613BEA	20
Bussole esagonali lunghe e corte, cricchetto (237 A) ed accessori 1/2	519 M 612CLA	35
Chiavi combinate a cricchetto reversibili (8-9-10-1-12-13-14-15-16-17-18-19 mm)	519 M 285 KA	12
Chiavi combinate (6-7-8-9-10-1-12-13-14-15-16-17-18-19-22-24 mm)	519 M 285A1	17
Chiavi combinate (27-29-30-32-34 mm)	519 M 285A2	5
Chiave a rullino rapida e corta, pinza autobloccante e forbice	519 M 294B	4
Giraviti per viti ad intaglio ed a croce PHILLIPS	519 M 324H	7
Giraviti per viti TORX	519 M 324STX	8
Chiavi maschio esagonali con impugnatura (3-4-5-6-7-8-10 mm)	519 M 280HG	7
Cassetta inserti assortita e chiavi maschio esagonali / TORX	519 M 280N1	117
Pinze per anelli elastici interni ed esterni 15÷25 e 19÷60	519 M 127C	6
Pinza universale, pinza regolabile, tronchese, pinza becchi lunghi e pinza grip	519 M 150AX	5
Lime a taglio mezzodolce	519 M 990A5B	5
Martello per meccanici, mazzuola, cacciaspine, scalpello e bulino	519 M 382F	7



NON TROVI IL TUO ASSORTIMENTO IDEALE?

Vai subito su
kitplanner.usag.it
e realizzalo!

Moduli in plastica



519/127N
Cod.U05190716 **4** PEZZI

127 N 19÷60 · 127 PN 19÷60 ·
128 N 19÷60 · 128 PN 19÷60.

€ 103,10 | **€ 72,00**



519/150AX
Cod.U05190850 **5** PEZZI

133 AX 160 · 134 250 · 150 AX 180 ·
180 C 250 · 188 AX 160.

€ 153,70 | **€ 108,00**



519/280HG
Cod.U05191860 **7** PEZZI

280 HG 3-4-5-6-7-8-10 mm.

€ 103,00 | **€ 72,00**



519/280HGTS
Cod.U05191861 **7** PEZZI

280 HGTS 3-4-5-6-7-8-10 mm.

€ 112,60 | **€ 79,00**



519/285A1
Cod.U05190785 **25** PEZZI

285 6-7-8-9-10-11-12-13-14-15-16-17-
18-19-22-24 280 S9 1,5÷10.

€ 173,25 | **€ 121,00**



519/285B2
Cod.U05190823 **4** PEZZI

285 27-29-30-32.

€ 94,30 | **€ 66,00**



519/285KA1
Cod.U05190788 **12** PEZZI

285 KA 8-9-10-11-12-13-14-15-
16-17-18-19.

€ 222,10 | **€ 155,00**



519/294
Cod.U05190732 **9** PEZZI

204 250 · 294 A 250 · 367 2x110-3x130-
4x145-5x165-6x180-8x200 · 981 A3.

€ 113,40 | **€ 79,50**



519/322H
Cod.U05190772 **10** PEZZI

322 0,5x3x75-0,8x4x100-1x5,5x125-
1,2x6,5x150-1,6x8x175 · 322 PH 0x75-1x100-
2x125 · 322 N 0,8x4x30 · 322 NPH 2x30.

€ 57,15 | **€ 40,00**



519/322STX
Cod.U05190831 **6** PEZZI

322 STX T10-T15-T20-T25-T30-T40.

€ 51,15 | **€ 35,80**



519/324H
Cod.U05190763 **10** PEZZI

324 0,5x3x75-0,8x4x100-1x5,5x125-
1,2x6,5x150-1,2x8x200 · 324 PH 0x75-1x75-
2x100 · 324 N 0,8x4x35 · 324 NPH 2x35.

€ 73,70 | **€ 51,50**



519/324TX
Cod.U05190764 **9** PEZZI

324 TX T6x50-T7x50-T8x50-T9x75 · 324 STX
T10x75-T15x75-T20x100-T25x100-T30x125.

€ 97,55 | **€ 68,50**



519/366
Cod.U05190740 **7** PEZZI

351 200 · 362 125-150 · 364 125 ·
366 3x125 · 4x150 · 368 4x125.

€ 75,65 | **€ 53,00**



519/382F
Cod.U05190742 **8** PEZZI

362 150 · 367 2x100-3x130-4x145-
5x165 · 368 4x125 · 376 35 · 382F 500.

€ 94,15 | **€ 66,00**



519/613AEA
Cod.U05190784 **42** PEZZI

235 1/4" EN 4-4,5-5-5,5-6-7-8-9-10-11-12-13-
14 · 236 1/4" 50-150 · 237 A 1/4" · 240 1/4" ·
241 1/4" · 243 1/4" · 692 S11 · 692 STX/S11 ·
684 1/4"-1/4".

€ 195,10 | **€ 137,00**



519/613BEA
Cod.U05190747 **21** PEZZI

235 3/8" E 6-7-8-9-10-11-12-13-14-15-
16-17-18-19-21-22 · 236 3/8" 125-250 ·
237 A 3/8" · 240 3/8" N · 241 3/8".

€ 199,30 | **€ 140,00**



519/613CEA
Cod.U05190750 **22** PEZZI

235 1/2" EN 10-11-12-13-14-15-16-
17-18-19-20-21-22-24-27-30-32 · 236
1/2" 125-250 · 237 A 1/2" · 240 1/2" N
· 241 1/2".

€ 239,80 | **€ 168,00**



519/990A1
Cod.U05190825 **4** PEZZI

990 M PA/200 · 990 M PB/200
990 M PC/200 · 990 M PE/200.

€ 54,20 | **€ 37,90**



8 PEZZI **XXL**

519/276
Cod.U05190725

276 CE 7-8-10-11-13-14-17-19.

€ 285,90 | **€ 200,00**



8 PEZZI **XL**

519/280T
Cod.U05190727

280 T 2-2,5-3-4-5-6-8-10.

€ 146,40 | **€ 102,00**



CREA IL TUO
Questa è solo
disponib

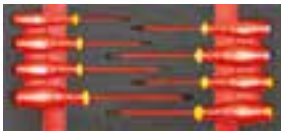

519 M 091A
Cod.U05191016 **8 PEZZI**
091 0,5x3x75-0,8x4x100-1x5,5x125
1,2x6,5x150 · 091 PH 1x100-2x125
· 091 PZ 1x100-2x125.
€ 86,60 | **€ 60,50**



519 M 127N
Cod.U05190937 **4 PEZZI**
127 N 19÷60 · 127 PN 19÷60 ·
128 N 19÷60 · 128 PN 19÷60.
€ 108,50 | **€ 76,00**



519 M 150AX
Cod.U05190965 **5 PEZZI**
133 AX 160 · 134 250 · 150 AX 180 ·
180 C 250 · 188 AX 160.
€ 159,10 | **€ 111,00**

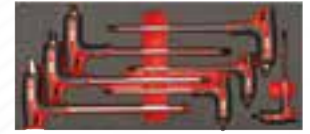

519 M 280HG
Cod.U05191945 **7 PEZZI**
280 HG 3-4-5-6-7-8-10 mm.
€ 108,40 | **€ 76,00**



519 M 280HGTS
Cod.U05191946 **7 PEZZI**
280 HGTS 3-4-5-6-7-8-10 mm.
€ 118,00 | **€ 82,50**



519 M 280N1
Cod.U05191013 **117 PEZZI**
280 S9 1,5-2-2,5-3-4-5-6-8-10 · 280 TX/
S8C T10-T15-T20-T25-T27-T30-T40-T45
· 692 J100.
€ 124,30 | **€ 87,00**



519 M 280TK
Cod.U05190935 **6 PEZZI**
280 TK 2,5-3-4-5-6-8.
€ 112,70 | **€ 79,00**



519 M 285A1
Cod.U05190921 **17 PEZZI**
285 6-7-8-9-10-11-12-13-14-15-16-
17-18-19-21-22-24.
€ 167,15 | **€ 117,00**

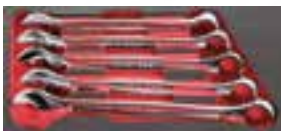

519 M 285A2
Cod.U05190943 **5 PEZZI**
285 27-29-30-32-34.
€ 136,20 | **€ 95,50**



519 M 285KA
Cod.U05190944 **12 PEZZI**
285 KA 8-9-10-11-12-13-14-15-
16-17-18-19.
€ 227,50 | **€ 159,00**



519 M 322H
Cod.U05190927 **8 PEZZI**
322 0,5x3x75-0,8x4x100-1x5,5x125-
1,2x6,5x150-1,6x8x175 · 322 PH 0x75-
1x100-2x125.
€ 52,25 | **€ 36,60**



519 M 322STX
Cod.U05190929 **6 PEZZI**
322 STX T10x75-T15x75-T20x100-
T25x100-T30x125-T40x125.
€ 56,55 | **€ 39,60**



519 M 324H
Cod.U05190910 **8 PEZZI**
324 0,5x3x75-0,8x4x100-1x5,5x125-
1,2x6,5x150 · 324 PH 1x100-2x125
324 D 0,6x3,5x100 324 E 1,6x8x175.
€ 70,05 | **€ 49,00**



519 M 324STX
Cod.U05190911 **7 PEZZI**
324 STX T10x75-T15x75-T20x100-
T25x100-T27x100-T30x125-T40x150.
€ 98,20 | **€ 68,50**



519 M 382F
Cod.U05190926 **7 PEZZI**
362 175 · 367 2x100-3x130-6x180
368 3x100 · 376 28 · 382F 500.
€ 115,05 | **€ 80,50**

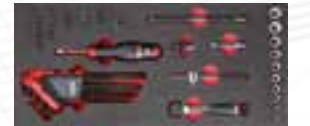

519 M 613AEA
Cod.U05190940 **237 A** **46 PEZZI**
235 1/4" EN 5,5-6-7-8-9-10-11-12-13-14
· 236 1/4" 50-100 · 237 A 1/4" · 240 1/4"
· 241 1/4" · 243 1/4" · 280 LTS/S9 · 684
1/4"-1/4" · 660 0,6-1-1,6 · 660 E 3-4-5-6-
8 · 660 PH 1-2-3 · 660 PZ 1-2-3 · 660 STX
T15-T20-T25-T27-T30-T40.
€ 231,60 | **€ 162,00**



519 M 613BEA
Cod.U05190928 **237 A** **20 PEZZI**
235 3/8" E 7-8-9-10-11-12-13-14-15-16-
17-18-19-21-22 · 236 3/8" 125-250 ·
237 A 3/8" · 240 3/8" N · 241 3/8".
€ 198,95 | **€ 139,00**



519 M 613CEA
Cod.U05190942 **237 A** **23 PEZZI**
235 1/2" EN 8-10-11-12-13-14-15-16-
17-18-19-21-22-23-24-27-30-32 · 236
1/2" 125-250 · 237 A 1/2" · 240 1/2" N
· 241 1/2".
€ 251,90 | **€ 176,00**



519 M 990A5MD
Cod.U05191011 **5 PEZZI**
990 M PA/200 · 990 M PB/200 · 990 M
PC/200 · 990 M PD/200 · 990 M PE/200.
€ 71,90 | **€ 50,50**

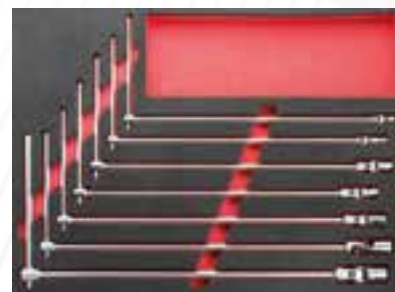

7 PEZZI **XXL**
519 M 276
Cod.U05190936
276 CE 7-8-10-11-13-17-19.
€ 263,10 | **€ 184,00**

ASSORTIMENTO IDEALE:
una selezione dei 200 moduli
ili su kitplanner.usag.it

13 kg | 460 mm | 158 mm | 385 mm



002 JMA

Cod. U00020011

Valigia con assortimento per manutenzione

- Valigia con struttura in profilato di Alluminio.
- Doppia cerniera di chiusura in metallo con serratura.
- 3 pannelli portautensili interni con elastici di tenuta.
- Base con interno in spugna bicolore sagomata.

€ 679,05 | **€ 389,00**



PINZE SERIE AX, GIRAVITI 324 E CHIAVE A RULLINO 294 AD!



181 PEZZI



002 JTMA

Cod. U00020015

Valigia trolley con assortimento per manutenzione

- Valigia con struttura in profilato di Alluminio.
- Doppia cerniera di chiusura in metallo con serratura.
- 3 pannelli portautensili interni con elastici di tenuta.
- Base con interno in spugna bicolore sagomata.

€ 679,05 | **€ 409,00**



RUOTE INTEGRATE NELLA STRUTTURA



14 kg | 485 mm | 200 mm | 377 mm



002 UDM

Cod. U00021706W

Valigia con assortimento per manutenzione

- Valigia con struttura in profilato di Alluminio.
- Doppia cerniera di chiusura in metallo con serratura.
- 3 pannelli portautensili interni con elastici di tenuta.
- Base con interno in mousse bicolore sagomata.

10 kg | 460 mm | 158 mm | 385 mm

~~€ 868,00~~ | **€ 429,00**

74
UTENSILI

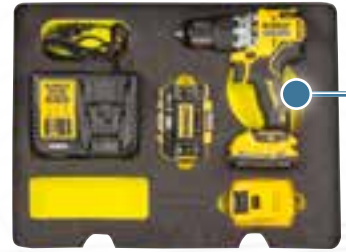
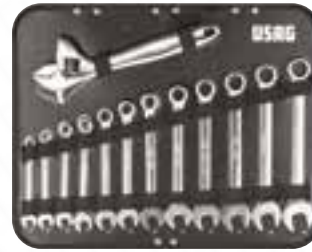

INSIEME UNICI

002 UDE

Cod. U00022706W

Valigia con assortimento per elettricisti

~~€ 710,00~~ | **€ 429,00**

74
UTENSILI

10 kg | 460 mm | 158 mm | 385 mm

1000 V

NEW

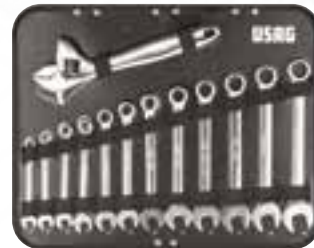

Modello con percussione

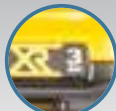

Batterie da 3.0 AH

DCD706

Trapano avvitatore a percussione

- Coppia 57Nm.
- 0-425/1500 giri/minuto.
- Mandrino in metallo autoserrante 1-10mm.
- Caricabatterie rapido.

12V XR

**2 BATTERIE 12V
3.0 AH INCLUSE**



Contenitori trasportabili



Resistente agli urti



Resistente alle alte e basse temperature



Anti corrosione



MAX
20 kg

4,7 kg | 465 mm | 352 mm | 215 mm

001 RV

Cod. U00010004

Valigia porta utensili in polipropilene ad alto spessore (vuota)

- Due pannelli interni amovibili con elastici portautensili.
- Vano inferiore con divisori amovibili e regolabili.
- Doppia serratura con chiave.
- Maniglia ergonomica rivestita in gomma.
- 3 cerniere posteriori e doppio braccetto di tenuta coperchio in metallo.
- Gusci in polipropilene ad alto spessore montati su un'intelaiatura di alluminio.
- La struttura garantisce resistenza alle sostanze corrosive, alle basse ed alte temperature ed agli urti anche sugli angoli.

~~€ 276,00~~ | **€ 193,00**



MAX
20 kg

6 kg | 465 mm | 352 mm | 255 mm

001 TRV

Cod. U00010005

Valigia trolley porta utensili in polipropilene ad alto spessore (vuota)

- Maniglia telescopica in alluminio.
- Ruote con cuscinetto a sfera integrato.

~~€ 407,00~~ | **€ 285,00**



641 T

Cassetta portautensili (vuota)

- In materiale plastico ad alta resistenza.
- 2 scomparti portaminuteria sul coperchio.
- Possibilità di chiusura con lucchetto (non fornito).
- Vassoio interno amovibile.

	CODICE	L (mm)	P (mm)	H (mm)	kg	
A	U06410004	16"	394	220	1,2	€ 22,30 € 15,60
B	U06410005	19"	486	266	2,1	€ 33,40 € 23,40
C	U06410006	24"	595	281	2,8	€ 44,50 € 31,10



Sistema di apertura con una sola mano



Possibilità di chiusura con lucchetto (non fornito)



2 scomparti portaminuteria sul coperchio

5
SCOMPARTI



646/5LV

Cod. U06460301

Cassetta estensibile LUNGA (vuota)

- Predisposizione per lucchetto.
- Struttura in lamiera d'acciaio con verniciatura anaforetica.
- Versione lunga della cassetta 646/5V.
- Dimensioni interne:
 - vano 537x207x100 mm.
 - scomparti 537x103x52 mm.

~~€ 67,50~~ | **€ 51,00**



8
VASCHETTE

640 A

Cod. U06400001

Organizer (vuoto)

- Coperchio trasparente: visibilità istantanea del contenuto.
- 8 vaschette interne amovibili di cui 1 suddivisibile tramite 2 divisori in dotazione.
- Blocco delle vaschette interne tramite chiusura del coperchio.
- Clip esterne di chiusura in materiale plastico.

~~€ 29,90~~ | **€ 20,90**



5003/1

Vaschetta in plastica multiuso



	CODICE	L (mm)	P (mm)	H (mm)		
A	U50030001Q	115	165	75	86 g	€ 2,95 € 2,05
B	U50030002Q	160	230	125	180 g	€ 6,30 € 4,40
C	U50030003Q	220	340	165	412 g	€ 11,80 € 8,25



420 mm



007/1V

Cod. U00070001



Tutta l'attrezzatura a portata di mano

Borsa portautensili (vuota)

- Nylon ad altissima resistenza.
- Base rigida e resistente all'acqua.
- Pratici e comodi vani interni portautensili.
- Due tasche frontali portaminuteria.
- Pratico maniglione in alluminio.
- Ganci interni porta flessometro ed elastici portautensili.
- Mantella di chiusura tramite velcro.

~~€ 75,50~~ | **€ 53,00**



490 mm



007 V

Cod. U00070002



Tasca frontale porta seghetto

Borsa portautensili (vuota)

- Nylon ad altissima resistenza.
- Base rigida resistente all'acqua.
- Vani interni portautensili e tasca frontale porta seghetto.
- Maniglione in alluminio con impugnatura rivestita.
- Cinghia di trasporto a tracolla.
- Mantella di chiusura con velcro.

~~€ 98,00~~ | **€ 69,00**



550 mm

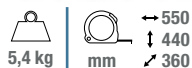

007 TXV

Cod. U00070065



Borsa trolley portautensili (vuota)

- Tessuto ad altissima resistenza
- Maniglia telescopica.
- Ruote con diametro 90 mm.
- 6 tasche esterne e 1 tasca frontale porta seghetto.
- Vani interni portautesili.
- Maniglione in alluminio con impugnatura rivestita.
- Mantella di chiusura con velcro.

~~€ 156,00~~ | **€ 109,00**



Tasca frontale porta seghetto



Ruote con diametro 90 mm



Maniglia telescopica



Cinghia posteriore per fissare la borsa al trolley



8 pratici vani e 6 elastici portautensili



Compatibile con

TSTAK™

STANLEY: FMST1-71968

DeWALT: DWST1-70705



007 FTSV

Cod. U00070060

Borsa portautensili pieghevole (vuota)

- Tessuto ad altissima resistenza.
- 8 pratici e comodi vani portautensili.
- Pannello centrale con elastici portautensili in entrambi i lati.
- Asole porta martello.
- Maniglia superiore con rivestimento in gomma.
- Cinghia posteriore per fissare la borsa al trolley.
- Possibilità di essere utilizzata con tracolla (non inclusa).
- Codice tracolla: U00070001Q.

~~€ 34,70~~ | **€ 24,30**



007 RV

Cod. U00070033

Borsa per utensili e PC (vuota)

- Tessuto ad altissima resistenza.
- Base rigida rinforzata.
- Può contenere Notebook di dimensioni L:340 mm - H:240 mm.
- 14 tasche, 2 cinghie portautensili e 1 gancio ferma flessometro.
- Tracolla amovibile per un comfort extra nel trasporto.
- Chiusura tramite fibbie a scatto con sgancio rapido.

~~€ 64,50~~ | **€ 45,10**

L'apertura frontale consente un rapido accesso al contenuto.



Tasca porta Notebook o documenti



Tasca porta Notebook o documenti



007 SV

Cod. U00070004

Zaino portautensili (vuoto)

- Nylon ad altissima resistenza.
- Cinturino pettorale regolabile.
- Cinghie in vita imbottite.
- Base rigida resistente all'acqua.
- Vano interno portautensili.
- Portadocumenti interno.
- La tasca posteriore può contenere Notebook di dimensioni: L 340 mm - H 240 mm.

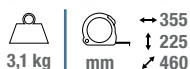

~~€ 92,00~~ | **€ 64,50**

007 TV

Cod. U00070006

Trolley portautensili (vuoto)

- Dimensioni bagaglio a mano (cabin size).
- Tessuto ad altissima resistenza.
- Pratici e comodi vani interni portautensili.
- Tasca frontale portadocumenti.
- Tasche laterali con cinghie per il trasporto di oggetti lunghi.
- Asta telescopica in alluminio.
- Ruote integrate nella struttura.
- Bretelle posteriori per il trasporto a spalla.
- La tasca posteriore può contenere Notebook di dimensioni L:340 mm - H:240 mm.

~~€ 114,00~~ | **€ 80,00**

GIRAVITI 324 IL TOP DEL MERCATO.



IMPUGNATURA TRIMATERIALE

- 1 Esterno in poliuretano resistente ad oli ed agenti chimici.
- 2 Corpo in poliammide resistente agli sforzi.
- 3 Interno in poliammide ad alta densità per un perfetto accoppiamento alla lama.

LAMA RINFORZATA

Acciaio al cromo silicio vanadio per la massima resistenza meccanica.

PUNTA AL TOP

Finitura zincata. Geometria perfetta. Trattamento anti corrosione.

GEOMETRIA ANTI-ROTOLO

RIVESTIMENTO SOFT GRIP
Miglior comfort durante l'uso. Maggiore trasmissione della coppia.

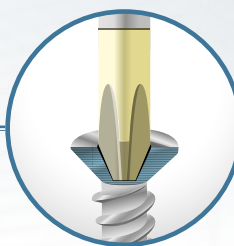
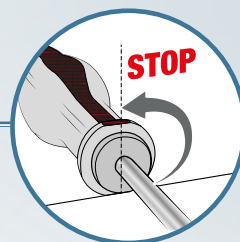

YouTube



324 SH8

Cod. U03240650

Serie di 8 giraviti per viti con intaglio e impronta a croce PHILLIPS®

- 324 D/0,4x2,5x50.
- 324/0,5x3x75-0,8x4x100-1x5,5x125-1,2x6,5x150.
- 324 PH/0x75-1x75-2x100.

~~€ 47,60~~ | **€ 29,90**

8
PEZZI



324 SH5

Cod. U03240645

Serie di 5 giraviti per viti con intaglio e impronta a croce PHILLIPS®

- 324/0,8x4x100-1x5,5x125.
- 324 PH/0x75-1x75-2x100.

~~€ 31,90~~ | **€ 20,90**

5
PEZZI





12
PEZZI

324 SH12

Cod. U03240651

Serie di 12 giraviti per viti con intaglio, impronta a croce PHILLIPS® e impronta a croce POZIDRIV® - SUPADRIV®



- 324 D/0,4x2,5x50.
- 324/0,5x3x75-0,8x4x100-1x5,5x125-1,2x6,5x150.
- 324 N/1x5,5x35.
- 324 PH/0x75-1x75-2x100.
- 324 NPH/2x35.
- 324 PZ/1x75-2x100.

~~€ 80,50~~ | **€ 53,50**



7
PEZZI

324 STX/S7

Cod. U03240662

Serie di 7 giraviti con impronta TORX® Tamper Resistant



- 324 STX T10x75-T15x75-T20x100-T25x100-T27x100-T30x125-T40x150.

~~€ 87,30~~ | **€ 61,00**



5
PEZZI

324 L/SH5

Cod. U03240422

Serie di 5 giraviti lunghi per viti con intaglio e impronta a croce PHILLIPS®



- 324 L 0,6x3,5x250-0,8x4x300-1x5,5x300.
- 324 LPH 1x250-2x250.

~~€ 55,95~~ | **€ 39,20**





COMBIDRIVE 333K NUOVO DESIGN DELL'IMPUGNATURA.

8
PEZZI

NEW



1/4

333 K/SH8

Cod. U03330142



Assortimento COMBIDRIVE con inserti

- Fornito con una selezione di 6 inserti da 1/4".

DESCRIZIONE	ARTICOLO/MISURA	PZ
Impugnatura Combidrive	333 K	1
Lama portainseri magnetica	333 1/4 MG	1
Inserti ad intaglio	660/0,6x4,5-1x5,5	2
Inserti a croce PH	660 PH 1-2	2
Inserti esagonali	660 E 3-4	2

~~€ 57,40~~ | **€ 39,00**



Fornito senza
inserti USAG 660

10
PEZZI

NEW

1/4

333 K/SB10

Cod. U03330143



Assortimento COMBIDRIVE in astuccio di nylon

- Fornito con una selezione di lame.
- Include un astuccio da cintura in nylon.

DESCRIZIONE	ARTICOLO/MISURA	PZ
Impugnatura Combidrive	333 K	1
Lama portainseri magnetica	333 1/4 MG	1
Lame reversibili ad intaglio	333 I 0,6x3,5-0,8x4/1x5,5-1,2x6,5	2
Lame reversibili a croce PH	333 PH 0-1/2-3	2
Lame reversibili TORX®	333 TX T8-T9 333 STX T10-T15/T20-T25/T30-T40	4

~~€ 101,60~~ | **€ 69,00**



23
PEZZI

NEW

1/4

333 K/SC23

Cod. U03330149



Assortimento COMBIDRIVE in cassetta di ABS

- Fornito con una selezione di lame ed inserti.
- Include una cassetta in ABS con modulo in spugna bicolore.

DESCRIZIONE	ARTICOLO/MISURA	PZ
Impugnatura Combidrive	333 K	1
Portabussole Combidrive	333 1/4 Q	1
Lama portainseri magnetica	333 1/4 MG	1
Lame reversibili esagonali	333 E 2,5-3-4-5-6	5
Lame reversibili a croce PH	333 PH 0-1/2-3	2
Lama reversibile ad intaglio	333 I 1x5,5-1,2x6,5	1
Lame reversibili TORX®	333 TX T8-T9 333 STX T10-T15/T20-T25/T30-T40	4
Inserti ad intaglio	660 0,6x4,5-1x5,5-1,2x6,5-1,6x8	4
Inserti a croce PZ	660 PZ 0-1-2-3	4

~~€ 161,80~~ | **€ 109,00**

GIRAVITI 322

QUALITÀ E CONVENIENZA.

7
PEZZI

322 SH7

Cod. U03220254

Serie di 7 giraviti per viti con intaglio e impronta a croce PHILLIPS®

- 322//0,4x2x50-0,5x3x75-0,8x4x100-1,5x100-1,2x6,5x150.
- 322 PH/1x100-2x125.

~~€ 33,30~~ | **€ 23,30**

10
PEZZI

322 SH10

Cod. U03220255

Serie di 10 giraviti per viti con intaglio, impronta a croce PHILLIPS® e impronta a croce POZIDRIV®

- 322//0,4x2x50-0,5x3x75-0,8x4x100-1x5,5x100-1,2x6,5x150.
- 322 PH/0x75-1x100-2x125.
- 322 PZ/1x100-2x125

~~€ 49,50~~ | **€ 34,60**

GIRAVITI 091

ISOLATI 1000 V - EN 60900.

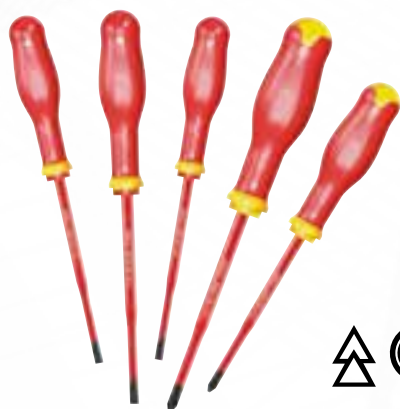
USAG SLIM
5
PEZZI

091 D/SH5

Cod. U00910119

Serie di 5 giraviti SLIM per viti con intaglio e per viti con impronta a croce PHILLIPS®

- 091 D/0,6x3,5x100-0,8x4x100-1x5,5x125.
- 091 DPH/1x100-2x125.

~~€ 53,00~~ | **€ 37,10**

5
PEZZI

091 SH5

Cod. U00910100

Serie di 5 giraviti per viti con intaglio e per viti con impronta a croce PHILLIPS®

- 091//0,5x3x75-0,8x4x100-1x5,5x125.
- 091 PH/1x100-2x125.

~~€ 43,60~~ | **€ 30,50**

8
PEZZI

091 SH8

Cod. U00910106

Serie di 8 giraviti per viti con intaglio, per viti con impronta a croce PHILLIPS® e impronta a croce POZIDRIV® - SUPADRIV®

- 091//0,5x3x75-0,8x4x100-1x5,5x125-1,2x6,5x150.
- 091 PH/1x100-2x125.
- 091 PZ/1x100-2x125.

~~€ 75,00~~ | **€ 52,50**



32
PEZZI  **1/4**







 280 g |  mm  138
 30
 98



692 J32

Cod. U06920042

Assortimento di inserti con cricchetto

DESCRIZIONE	MISURA		PZ.
Inserti ad intaglio	4-5,5-6,5-8		4
Inserti a croce PHILLIPS®	PH 1-2-3		3
Inserti a croce POZIDRIV®	PZ 1-2-3		3
Inserti esagono maschio	3-4-5-6		4
Inserti TORX®	T8-10-15-20-20-25-25-30-40		9
Inserti TORX® Tamper Resistant	STX 10-15-20-25-27-30-40		7
Portainseri magnetico			1
Cricchetto			1

~~€ 51,50~~ | **€ 36,00**



49
PEZZI  **1/4**







 280 g |  mm  138
 30
 98



692 J49

Cod. U06920041

Assortimento di inserti

DESCRIZIONE	MISURA		PZ.
Inserti ad intaglio	4-4,5-5,5-6,5-6,5-8		6
Inserti a croce PHILLIPS®	PH 1-1-2-2-2-3		6
Inserti a croce POZIDRIV®	PZ 1-1-2-2-2-3-3		7
Inserti esagono maschio	2-3-3-4-4-5-5-6-6		9
Inserti TORX®	TX 10-10-15-15-20-20-25-25-30-30		10
Inserti TORX® Tamper Resistant	STX 10-15-15-20-20-25-25-30-30-40		10
Portainseri magnetico			1

~~€ 39,80~~ | **€ 27,90**



Riconoscimento dell'inserto con codice colore per una scelta rapida

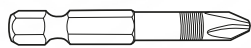

-----50 mm-----







664 S25

Cod. U06640111

Assortimento di inserti per avvitatura

- Fornito in cassetta di plastica

DESCRIZIONE	MISURA		PZ.
Inserti lunghi ad intaglio	3-4-5-6		4
Inserti lunghi a croce PH	1-2(x2)-3(x1)		5
Inserti lunghi a croce PZ	1-2(x2)-3(x1)		5
Inserti lunghi TORX®	T15-T20-T25-T30-T40		5
Inserti lunghi esagonali	2-3-4-5-5,5		5
Portainseri magnetico			1

~~€ 64,00~~ | **€ 44,80**

25
PEZZI  **1/4**

 800 g |  mm  215
 45
 150

664 B/S7

Cod. U06640015

Assortimento di inserti a bussola

- Fornito in cassetta di plastica

~~€ 34,30~~ | **€ 24,00**



7
PEZZI  **1/4**



5,5-6-7-8
10-12-13 mm

 300 g |  mm  138
 30
 98





900 g | 215 mm
45 mm | 150

DESCRIZIONE	MISURA	PZ.
Inserti a intaglio	3-4-4,5-5-5,5-6-6,5-7-8	9
Inserti a croce	PH 00-0-1-1-2-2-3-4 PZ 1-2-2-3-4	13
Inserti esagono maschio	1,5-2-2,5-3-4-5-5,5-6-7-8 mm 1/16-5/64-3/32-7/64-1/8-9/64-5/32-3/16-7/32-1/4"	20
Inserti TORX®	T 8-9-10-15-20-25-27-30-40-45	10
Inserti TORX® Tamper Resistant	STX 8-10-15-20-25-27-30-35-40	9
Inserti Tri-Wing	1-2-3-4	4
Inserti Spanner	4-6-8-10-12	5
Inserti Torq-set	6-8-10	3
Inserti quadrati	0-1-2-2-3	5
Inserti Clutch	1/8-5/32-3/16-1/4-5/16	5
Inserti XZN	M5-M6-M8	3
Inserti esagono maschio con foro	2-2,5-3-4-5-6 mm - 5/64-3/32-7/64-1/8-9/64-5/32"	12
Portainseri magnetici	1/4x60mm	2

692 J100

Cod. U06920043

Assortimento di inserti con impronte speciali

~~€ 61,00~~ | **€ 42,70**

100 PEZZI

1/4



SUPPORTI COMPATTI CON SISTEMA DI ESTRAZIONE RAPIDA



Guarda il video dimostrativo



YouTube



9 PEZZI

280 LTS/S9

Cod. U02800084



Serie di 9 chiavi maschio esagonale lunghe testa sferica

• 280 LTS/1,5-2-2,5-3-4-5-6-8-10 mm.



~~€ 32,00~~ | **€ 19,90**



8 PEZZI

280 LTSTX/S8

Cod. U02800078



Serie di 8 chiavi maschio lunghe testa sferica TORX®

• 280 LTSTX/T10-T15-T20-T25-T27-T30-T40-T45.



~~€ 58,00~~ | **€ 40,60**



9 PEZZI

280 XLTS/S9

Cod. U02800184



Serie di 9 chiavi maschio esagonale extra-lunghe a testa sferica

• 280 XLTS/1,5-2-2,5-3-4-5-6-8-10 mm.



~~€ 35,51~~ | **€ 24,90**

CHIAVI MASCHIO 280 T SICUREZZA GARANTITA.



YouTube



ACCIAIO SPECIALE
al cromo vanadio.



CHIAVI USAG **ALTRE CHIAVI**

SICUREZZA GARANTITA

- +30% resistenza alla torsione rispetto alla norma ISO 2936.
- Raggiunta la coppia di rottura, la chiave si deforma senza spezzarsi.



TRAVERSINO FISSO
Massima resistenza.

7
PEZZI



280 T/SE7
Cod. U02800903

Serie di 7 chiavi a T con maschio esagonale
• 280 T/2,5-3-4-5-6-8 mm.

~~€ 112,60~~ | **€ 79,00**

8
PEZZI



280 TTX/SE8
Cod. U02800686

Serie di 8 chiavi a T per viti con impronta TORX®
• 280 TTX/T6-T7-T8-T9-T10-T15-T20-T25.

~~€ 159,50~~ | **€ 112,00**

6
PEZZI



280 TTS/SE6
Cod. U02800760

Serie di 6 chiavi a T maschio esagonali con testa sferica
• 280 TTS/2,5-3-4-5-6-8 mm.

~~€ 98,80~~ | **€ 69,00**



Testa sferica

6
PEZZI



280 TK/SE6
Cod. U02800020

Serie di 6 chiavi a T maschio esagonale con traversino scorrevole
• 280 TK/2,5-3-4-5-6-8 mm.

~~€ 101,80~~ | **€ 71,50**

Traversino scorrevole

CHIAVI MASCHIO 280 HG CON IMPUGNATURA ERGONOMICA.



SICUREZZA GARANTITA

- +30% resistenza alla torsione rispetto alla norma ISO 2936.
- Raggiunta la coppia di rottura, la chiave si deforma senza spezzarsi.

**Stessa lama
delle chiavi 280 T**

**IMPUGNATURA BIMATERIALE
ERGONOMICA.**

**ACCIAIO SPECIALE
AL CROMO VANADIO.**



**6
PEZZI**



280 HG/SE6

Cod. U02801460

Serie di 6 chiavi maschio esagonale con impugnatura

- 280 HG/2,5-3-4-5-6-8 mm.

~~€ 74,60~~ | **€ 52,00**



**6
PEZZI**



280 HGTS/SE6

Cod. U02801463

Serie di 6 chiavi maschio esagonale a testa sferica con impugnatura

- 280 HGTS/2,5-3-4-5-6-8 mm.

~~€ 82,10~~ | **€ 57,50**



**6
PEZZI**



280 HAP/SE6

Cod. U02800462

Serie di 6 chiavi maschio esagonale in pollici con impugnatura

- 280 HAP/1/4-7/32-5/32-5/16-3/8-3/16".

~~€ 73,40~~ | **€ 51,50**

**6
PEZZI**



280 HATX/SE6

Cod. U02800464

Serie di 6 chiavi maschio con impugnatura per viti con impronta TORX®

- 280 HATX/T8-T10-T15-T20-T25-T30.

~~€ 57,55~~ | **€ 40,30**

GAMMA PINZE "AX"

FINITURA CROMATA ED IMPUGNATURE BIMATERIALE.



Taglia fino a Ø 2 mm di filo armonico con il 30% in meno di forza rispetto al valore massimo indicato dalle normative europee ISO5749 (tronchesi) - ISO5746 (pinze).

YouTube



TAGLIENTI TEMPRATI AD INDUZIONE
per la massima efficacia nel taglio del filo armonico.



FULCRO PIÙ VICINO AI TAGLIENTI
per il minimo sforzo durante il taglio.

IMPUGNATURE ERGONOMICHE BIMATERIALE

IMPUGNATURA USAG



- SFORZO

PRODOTTI SUL MERCATO



+ SFORZO

Minimo sforzo risultante dagli studi sugli sforzi muscolari effettuati dal prestigioso istituto americano US Ergonomics.

3 PEZZI



150 AX/SE3
Cod. U01500201

Assortimento pinze e tronchesi

- Pinza universale 150 AX 180.
- Pinza a becchi mezzotondi lunghissimi diritti 133 AX 160.
- Tronchese a grande effetto a tagliente diagonale 188 AX 160.

~~€ 91,10~~ | **€ 64,00**

3 PEZZI



1000 V

085 EX/SE3
Cod. U00850121

Assortimento pinze e tronchesi isolati 1000 V

- Pinza universale 085 EX 180.
- Pinza a becchi mezzotondi lunghissimi diritti 081 EX 160.
- Tronchese a grande effetto a tagliente diagonale 087 EX 160.

~~€ 122,70~~ | **€ 86,00**

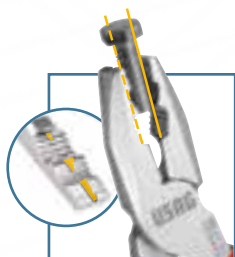

PROFILI TONDI

Intaglio ricavato nella dentatura per una presa sicura di barre tonde, anche filettate.

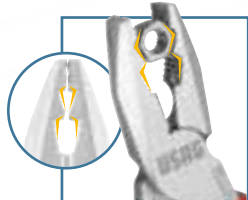

PROFILI ESAGONALI

Geometria delle ganasce studiata per la presa di un esagono.



155 AX
Cod. U01550001

Pinza universale multifunzione
~~€ 56,00~~ | **€ 33,00**

Pinza multifunzione

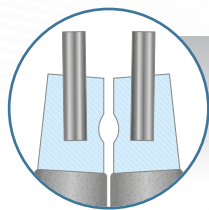

MASSIMA RESISTENZA

Punte in acciaio armonico inserite nei becchi.

4

PEZZI



4

PEZZI



127 N/SE4S

Cod. U01270046

Serie 4 pinze per anelli elastici

- Pinze per anelli elastici interni 127 N 12÷25-127 PN 12÷25.
- Pinze per anelli elastici esterni 128 N 10÷25-128 PN 10÷25.

~~€ 89,90~~ | **€ 63,00**

Misure
piccole

127 N/SE4

Cod. U01279000P

Serie 4 pinze per anelli elastici

- Pinze per anelli elastici interni 127 N 19÷60-127 PN 19÷60.
- Pinze per anelli elastici esterni 128 N 19÷60-128 PN 19÷60.

~~€ 97,60~~ | **€ 68,50**

Misure
grandi

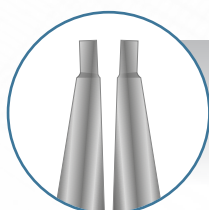

MASSIMA ACCESSIBILITÀ

Punte e becchi in corpo unico.

4

PEZZI



4

PEZZI



127 C/SE4S

Cod. U01270045

Serie 4 pinze per anelli elastici

- Pinze per anelli elastici interni 127 C 12÷25-127 CP 12÷25.
- Pinze per anelli elastici esterni 128 C 10÷25-128 CP 10÷25.

~~€ 75,00~~ | **€ 52,50**

Misure
piccole

127 C/SE4

Cod. U01270040

Serie 4 pinze per anelli elastici

- Pinze per anelli elastici interni 127 C 19÷60-127 CP 19÷60.
- Pinze per anelli elastici esterni 128 C 19÷60-128 CP 19÷60.

~~€ 81,80~~ | **€ 57,50**

Misure
grandi

PINZA CHIAVE 174 CX

PINZA E CHIAVE IN UN UNICO UTENSILE.



YouTube



**SISTEMA
DI CHIUSURA RAPIDA**
senza premere il pulsante.



BECCHI PIATTI E PARALLELI
Battuta sagomata
per far presa su 4 lati dell'esagono.



GANASCE SOTTILI

**CAPACITÀ MAX.
58 mm**

SCALA MILLIMETRATA

**CREMAGLIERA CON
20 POSIZIONI**

NEW

**MANICI RIVESTITI
IN PVC**

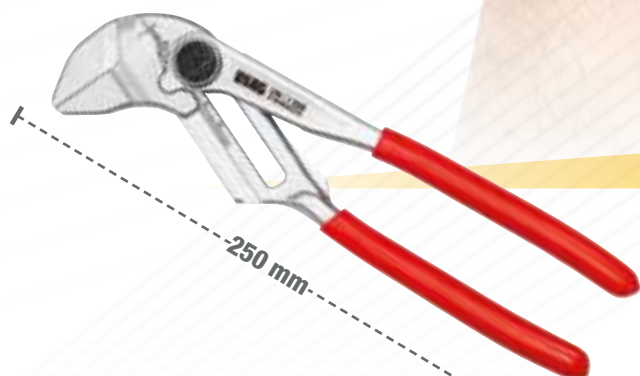

174 CX
Cod. U01740001

Pinza chiave regolabile

~~€ 70,00~~ | **€ 49,00**

NEW

**APERTURA
MAGGIORATA +20%**



YouTube

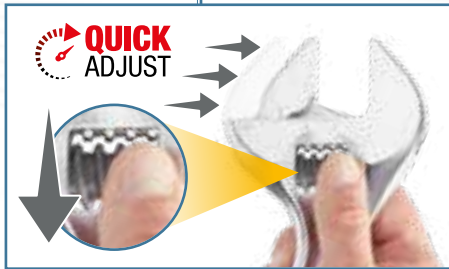

**ARRETRI IL RULLINO,
REGOLI RAPIDAMENTE.**

**RUOTI IL RULLINO,
REGOLI CON PRECISIONE.**

294 AD

Chiavi a rullino con regolazione rapida

- Si regola rapidamente arretrando il rullino.
- Grande capacità: apertura +20% rispetto allo standard.
- Doppia scala graduata: millimetri e pollici.
- Testa inclinata di 22°.
- Rullino in acciaio.
- Asola di aggancio.
- Finitura cromata.

CODICE	L	APERTURA	
U02940011	110 mm - 4"	17 mm	€ 18,20 € 12,70
U02940012	150 mm - 6"	23 mm	€ 19,10 € 13,40
U02940013	200 mm - 8"	33 mm	€ 22,80 € 16,00
U02940014	250 mm - 10"	38 mm	€ 29,00 € 20,30
U02940015	300 mm - 12"	41 mm	€ 38,10 € 26,70
U02940016	380 mm - 15"	50 mm	€ 70,00 € 49,00
U02940017	460 mm - 18"	63 mm	€ 115,00 € 80,50

**APERTURA
MAGGIORATA +20%**



YouTube

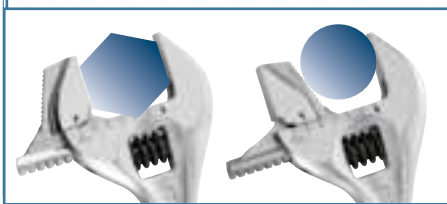

**POSIZIONE
STANDARD**

**GANASCIA
INVERTITA**

INVERTI

LA GANASCIA MOBILE
per passare dalla presa su
esagono a quella su tondo.

294 AG

Chiavi a rullino reversibili con impugnatura

- Nella posizione standard può manovrare un profilo esagonale.
- Invertendo il dente mobile, può manovrare un profilo tondo.
- Grande capacità: apertura +20% rispetto allo standard.
- Doppia scala graduata: millimetri e pollici.
- Impugnatura ergonomica bimateriale.
- Testa inclinata di 22°.
- Rullino in acciaio.
- Asola di aggancio.
- Finitura cromata.

CODICE	L	APERTURA	
U02940023	200 mm - 8"	33 mm	€ 25,00 € 17,50
U02940024	250 mm - 10"	38 mm	€ 31,90 € 22,30
U02940025	300 mm - 12"	41 mm	€ 41,90 € 29,30

**APERTURA
MAX 34 mm**



Solo 150 mm

294 AC

Cod. U02940010

Chiave regolabile a rullino corta

- Lunghezza ridotta del 46% rispetto ad una chiave standard.
- Apertura ganasce pari ad una chiave a rullino da 12".
- Leggera e compatta per un'ottima accessibilità.
- Regolazione tramite rullino in acciaio.
- Scala millimetrata sulla testa della chiave.
- Finitura cromata.

~~€ 22,70~~ | **€ 15,90**

-46%



**LUNGHEZZA RIDOTTA
DEL 46% RISPETTO AD
UNA CHIAVE STANDARD**

CHIAVE COMBINATA 285 RESISTENTE ED ERGONOMICA.



FORCHETTA INCLINATA

Angolo di 15° rispetto all'asse della chiave.

SEZIONE A DOPPIA T

Massima resistenza alla flessione.

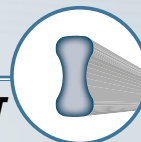

OCCHIO DISASSATO

Per dadi e bulloni incassati in posizioni di difficile accesso.

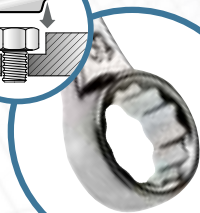

TOP PERFORMANCE

Resistenza alla torsione statica di anello e forchetta:
+50% rispetto alla norma ISO 1711-1.

ISO 1711-1
SAE AS 954E



8
PEZZI

8÷19 mm

285 DS8

Cod. U02850863

Serie di 8 chiavi combinate

- 285/8-10-11-12-13-14-17-19 mm.
- Fornita con supporto in plastica.

~~€ 74,05~~ | **€ 47,90**



26
PEZZI

6÷32 mm

285 SE26

Cod. U02850861

Serie di 26 chiavi combinate

- 285/6-7-8-9-10-11-12-13-14-15-16-17-18-19-20-21-22-23-24-25-26-27-28-29-30-32 mm.

~~€ 327,75~~ | **€ 223,00**

CHIAVE A CRICCHETTO 285 KA CON ANELLO DI TENUTA INTEGRATO.



SEZIONE A DOPPIA T
Massima resistenza alla flessione.

POSIZIONE OTTIMALE



ANELLO IN ACCIAIO ARMONICO INTEGRATO NELL'OCCHIO POLIGONALE
Mantiene la posizione sul dado durante la manovra.



FORCHETTA CON SISTEMA ANTISLITTAMENTO DEL DADO
Maggiore tenuta durante la manovra.

CRICCHETTO RESISTENTE

Resistenza alla torsione statica del cricchetto:
+50% rispetto alla norma ISO 1711-1.

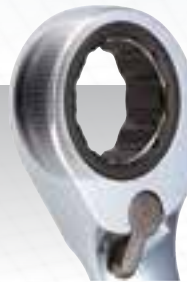

YouTube

8

PEZZI

8÷19 mm



285 KA/DS8

Cod. U02856058

Serie di 8 chiavi combinate a cricchetto con anello di tenuta

- 285 KA/8-10-11-12-13-14-17-19 mm.

~~€ 148,30~~ | **€ 98,50**

12

PEZZI

7÷19 mm



285 KA/DS12

Cod. U02856062

Serie di 12 chiavi combinate a cricchetto con anello di tenuta

- 285 KA/7-8-10-11-12-13-14-15-16-17-18-19 mm.

~~€ 224,20~~ | **€ 158,00**

Chiavi di manovra

8

PEZZI



8÷19 mm



TESTA SNODATA



285 KF/DS8

Cod. U02856158

Serie di 8 chiavi combinate a cricchetto snodate

- 285 KF/8-10-11-12-13-14-17-19 mm.

~~€ 173,70~~ | **€ 122,00**

8

PEZZI



8÷19 mm



CAMBIO DEL SENSO DI ROTAZIONE



285 KB/SR8

Cod. U02856339

Serie di 8 chiavi combinate a cricchetto piatte

- 285 KB/8-10-12-13-14-15-17-19 mm.

~~€ 114,45~~ | **€ 80,50**

4

PEZZI



22÷30 mm



NEW

285 L/SE4

Cod. U02850340

Serie di 4 chiavi combinate lunghe

- 285 L/22-24-27-30 mm.

~~€ 139,50~~ | **€ 97,50**

8
PEZZI

6÷22 mm



252 N/SR8

Cod. U02520862

Serie di 8 chiavi a forchetta doppie

- 252 N/6x7-8x9-10x11-12x13-14x15-16x17-18x19-20x22 mm.

~~€ 56,80~~ | **€ 39,80**

4
PEZZI

7÷13 mm



299 SE4

Cod. U02990200

Serie di 4 chiavi a bussola esagonale con impugnatura

- 299/7-8-10-13 mm.

~~€ 67,80~~ | **€ 47,50**

8
PEZZI

7÷19 mm

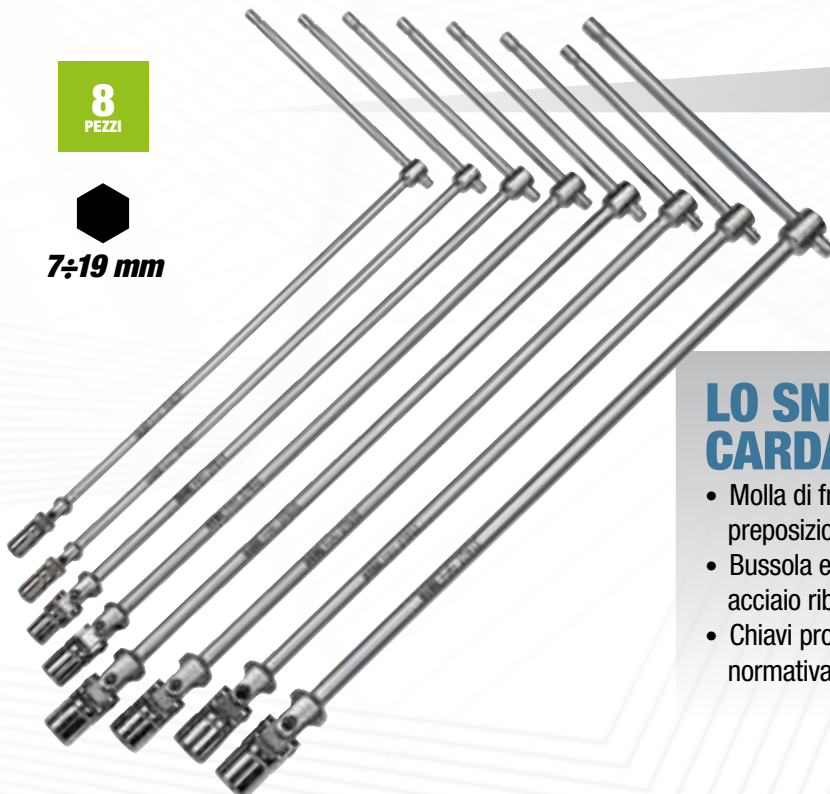

276 CE/SE8

Cod. U02760484

Serie di 8 chiavi a T snodate

- 276 CE/7-8-10-12-13-14-17-19 mm.

~~€ 275,00~~ | **€ 206,00**

LO SNODO CARDANICO USAG

- Molla di frizione interna per il perfetto preposizionamento della bussola.
- Bussola e cardano fissati con un perno in acciaio ribadito per la massima affidabilità.
- Chiavi progettate e prodotte rispettando la normativa UNI 6743.



CRICCHETTO 237 A CON MECCANISMO SIGILLATO IP51.



Sistema di inversione integrato nel coperchio



Spessore della testa ridotto rispetto ai modelli standard -10%



YouTube



IMPUGNATURA CONICA
in bimateriale e antiscivolo.

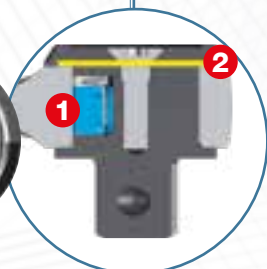

1. Nottolino brevettato.
2. Diaframma protettivo.

TOP PERFORMANCE

1. Resistenza alla torsione statica:
+30% di coppia rispetto alla norma ISO 3315 grazie al nottolino brevettato.
2. Resistenza a fatica:
dura il doppio dei normali cricchetti del mercato grazie alla protezione IP51.



23
PEZZI

1 1/2"

606 1/2" EA
Cod. U06060302

3 kg | mm | 330
60
215

Assortimento in cassetta di ABS con bussole esagonali
• Cassetta in ABS ad alta resistenza con sistema di chiusura rapida.

DESCRIZIONE	ART./MISURA	PZ.
Chiavi a bussola con bocca esagonale	235 1/2 EN 8-9-10-11-12-13-14-15-16-17-18-19-21-22-23-24-27-30-32	19
Prolunghe	236 1/2 125-250	2
Snodo cardanico	241 1/2	1
Cricchetto reversibile certificato IP51	237 A 1/2	1

~~€ 237,55~~ | **€ 142,00**



19
PEZZI

1 1/4"

606 1/4" EA
Cod. U06060101

1 kg | mm | 210
60
130

Assortimento in cassetta di ABS con bussole esagonali
• Cassetta in ABS ad alta resistenza con sistema di chiusura rapida.

DESCRIZIONE	ART./MISURA	PZ.
Chiavi a bussola con bocca esagonale	235 1/4 EN 4-4,5-5-5,5-6-7-8-9-10-11-12-13-14	13
Prolunghe	236 1/4 50-100	2
Snodo cardanico	241 1/4	1
Leva a T con attacco quadro scorrevole	240 1/4	1
Portabussole con impugnatura	243 1/4	1
Cricchetto reversibile certificato IP51	237 A 1/4	1

~~€ 124,85~~ | **€ 75,00**

CRICCHETTO 237 D CON QUADRO DI MANOVRA SCORREVOLE.

MECCANISMO A 60 DENTI
angolo di ripresa 6°.

NEW

IMPUGNATURA CONICA
in bimatereale e antiscivolo.

QUADRO SCORREVOLE
Premendo il quadro e ruotando il cricchetto di 180° si cambia il senso di manovra.

237 D

ARTICOLO	CODICE	□	L (mm)	€ 42,00 € 29,00
237 D 1/4"	U02370053	1/4"	125	€ 42,00 € 29,00
237 D 3/8"	U02370055	3/8"	200	€ 52,00 € 36,00
237 D 1/2"	U02370057	1/2"	260	€ 60,00 € 42,00



15
PEZZI

1/2"



NEW

2 kg | 330 mm | 60 | 215

604 1/2" ED
Cod. U06040300

Assortimento in cassetta di ABS con bussole esagonali
• Cassetta in ABS ad alta resistenza con sistema di chiusura rapida.

DESCRIZIONE	ART./MISURA	PZ.
Chiavi a bussola con bocca esagonale	235 1/2 EN 10-11-12-13-14-15-16-17-18-19-21-22-24	13
Prolunga	236 1/2 125	1
Cricchetto con quadro di manovra scorrevole	237 D 1/2	1

€ 164,65 | **€ 99,00**



12
PEZZI

1/4"



NEW

600 g | 210 mm | 60 | 130

605 1/4" ED
Cod. U06050100

Assortimento in cassetta di ABS con bussole esagonali
• Cassetta in ABS ad alta resistenza con sistema di chiusura rapida.

DESCRIZIONE	ART./MISURA	PZ.
Chiavi a bussola con bocca esagonale	235 1/4 EN 5,5-6-7-8-9-10-11-12-13	9
Prolunga	236 1/4 100	1
Cricchetto con quadro di manovra scorrevole	237 D 1/4	1
Portabussole con impugnatura	243 1/4	1

€ 91,45 | **€ 55,00**

Cricchetti e bussole



38
PEZZI

1/4"



900 g | 155 mm | 50 mm | 95 mm

609 1/4" EB

Cod. U06090002



Assortimento con bussole esagonali ed inserti per avvitatura

• Cassetta compatta in bimatereale con rivestimento soft-touch.

DESCRIZIONE	ART./MISURA	PZ.
Bussole esagonali	235 1/4" EN 5,5-6-7-8-9-10-11-12-13-14 mm	10
Prolungha	236 1/4" 50-100	2
Cricchetto reversibile	237 B 1/4"	1
Snodo cardanico	241 1/4"	1
Impugnatura porta-bussola	243 1/4"	1
Inserti ad intaglio	660 0,6x4,5-1x5,5-1,2x6,5	3
Inserti PH	660 PH 1-2-3	3
Inserti PZ	660 PZ 1-2-3	3
Inserti esagonali	660 E 2-3-4-5-6	5
Inserti TORX® Tamper Resistant	660 STX T10-T15-T20-T25-T27-T30-T40	7
Inserto porta-bussola	660 Q 1/4"	1
Bussola porta-inserti	684 1/4"-1/4"	1

€ 198,11 | € 139,00



YouTube

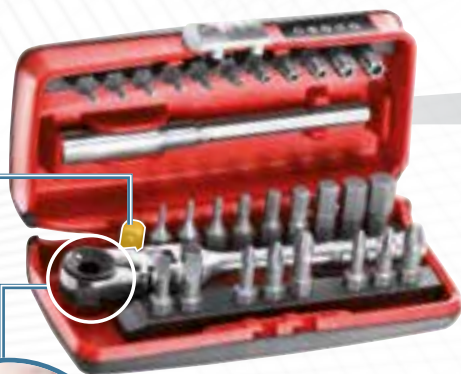

31
PEZZI

1/4"

Inserto portabussole



350 g | 120 mm | 35 mm | 65 mm



606 1/4" SK

Cod. U06060012

Assortimento inserti con cricchetto reversibile

DESCRIZIONE	ART./MISURA	PZ.
Cricchetto reversibile	237 1/4" SFK	1
Inserti ad intaglio	660 0,5x4-1x5,5	2
Inserti esagonali	660 E 1,5-2-2,5-3-4-5-6-7-8	9
Inserti a croce PHILLIPS®	660 PH 1-2-3	3
Inserti a croce POZIDRIV®- SUPADRIV®	660 PZ 1-2-3	3
Raccordo portainseriti	660 Q 1/4"	1
Inserti TORX® Tamper Resistant	660 STX T10-T15-T20-T25-T27-T30-T40	7
Inserti TORX®	660 TX T6-T7-T8-T9	4
Prolunga magnetica	672 1/4" MG 100	1

€ 68,50 | € 47,90



YouTube



11
PEZZI

1/4"

11 mm



265 g | 120 mm | 35 mm | 65 mm

5,5-6-7-8-9-10-11-12-13-14 mm

610 1/4" EFK

Cod. U06100001

Assortimento bussole ribassate con cricchetto reversibile

€ 82,71 | € 58,00

BUSSOLE ESAGONALI RIBASSATE

Garantiscono il doppio dell'accessibilità rispetto all'utilizzo di un cricchetto standard.

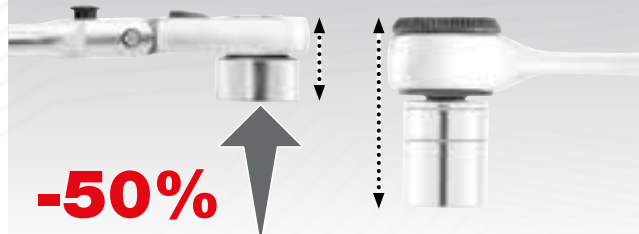

IL TOP PER GLI SPAZI RISTRETTI



50
PEZZI

1/4"



608 1/4" EAK

Cod. U06080305

↔ 435
↑ 70
↙ 270
mm

Assortimento in cassetta di ABS con prolunghe, cricchetto e bussole esagonali

- Cassetta in ABS ad alta resistenza con sistema di chiusura rapida.

DESCRIZIONE	ART./MISURA	PZ.
Chiavi a bussola con bocca esagonale	235 1/4 EN 4-4,5-5-5,5-6-7-8-9-10-11-12-13-14	13
Cricchetto con impugnatura rotante	237 1/4 AK	1
Portabussole con impugnatura	243 1/4	1
Portabussole flessibile con impugnatura	243 1/4 SN	1
Chiave a T con attacco quadro snodato	273 1/4 Q	1
Assortimento inserti con cricchetto reversibile - mini kit	606 1/4 SK	31
Raccordo aumentatore	247 1/4	1
Bussole portainseriti	684/1	1

~~€ 258,30~~ | **€ 169,00**



Chiave a T snodata



Impugnatura con lama flessibile



Cricchetto con Impugnatura rotante



Cricchetto porta inserti snodato

CRICCHETTI CON IMPUGNATURA ROTANTE

1/4"

237 1/4" AK

Cod. U02370003

Cricchetto reversibile 1/4" con impugnatura rotante

~~€ 49,80~~ | **€ 34,90**

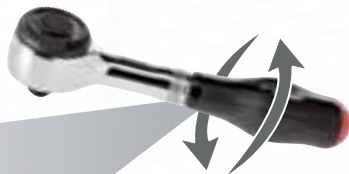

1/2"

237 1/2" AK

Cod. U02370009

Cricchetto reversibile 1/2" con impugnatura rotante

~~€ 81,50~~ | **€ 57,00**

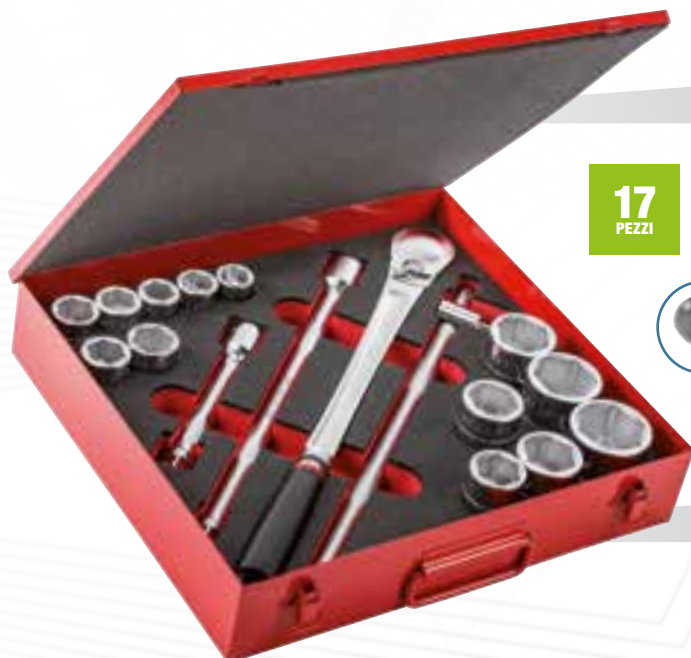

17
PEZZI

3/4"



612 3/4" EB

Cod. U06120017



13 kg | mm ↔ 425
↑ 83
↙ 395

Assortimento in cassetta di lamiera con bussole esagonali

DESCRIZIONE	ART./MISURA	PZ.
Chiavi a bussola con bocca esagonale	235 3/4 N 22-23-24-26-27-28-30-32-36-38-41-46-50	13
Prolunghe	236 3/4 200-400	2
Leva a T scorrevole	240 3/4 N	1
Cricchetto reversibile con meccanismo sigillato 120 denti	237 B 3/4	1

~~€ 548,40~~ | **€ 384,00**

612 3/4" B

Cod. U06120016



BUSSOLE POLIGONALI

Assortimento in cassetta di lamiera con bussole poligonali

~~€ 550,50~~ | **€ 384,00**



16
PEZZI

1/2"

1/4"



1 kg | mm | 190
58
144

601 1/4-1/2 JTX16

Cod. U06010009

Assortimento in cassetta modulare con bussole TORX®

DESCRIZIONE	MISURA	PZ.
Chiavi a bussola 1/4 TORX®	E6-E7-E8-E10	4
Chiavi a bussola 1/2 TORX®	E12-E14-E16-E18	4
Chiavi a bussola 1/4 con inserto TORX®	T10-T15-T20-T25	4
Chiavi a bussola 1/2 con inserto TORX®	T30-T40-T45-T50	4

~~€ 41,20~~ | **€ 28,80**



34
PEZZI

1/4"



1 kg | mm | 190
58
144

601 1/4 J34

Cod. U06010001

Assortimento in cassetta modulare con bussole esagonali ed inserti per avvitatura

DESCRIZIONE	MISURA	PZ.
Chiavi a bussola 1/4"	4-4,5-5-5,5-6-7-8-9-10-11-12-13-14	13
Cricchetto reversibile 1/4"		1
Snodo cardanico 1/4"		1
Prolunghe 1/4"	55-100	2
Inserti a intaglio	4-5,5-6	3
Inserti a croce POZIDRIV®	1-2-3	3
Inserti esagono maschio	4-5-6	3
Inserti TORX®	T10-T15-T20-T25-T30-T40	6
Impugnatura maschio/femmina		1
Raccordo portainseriti 1/4"		1

~~€ 66,50~~ | **€ 46,00**



22
PEZZI

1/2"



4 kg | mm | 375
80
186

601 1/2 J22

Cod. U06010003

Assortimento in cassetta modulare con bussole esagonali

DESCRIZIONE	MISURA	PZ.
Bussole esagonali 1/2"	8-10-11-12-13-14-15-16-17-18-19-21-22-24-27-30-32	17
Cricchetto 1/2"		1
Prolunghe 1/2"	130-250	2
Snodo cardanico 1/2"		1
Leva a T 1/2"		1

~~€ 116,00~~ | **€ 75,00**

LA QUALITÀ **USAG** A UN PREZZO *Just*



100
PEZZI

1/4" **1/2"**

8 kg | mm | 415
92
283



601 1/4-1/2 J100

Cod. U06010011

Assortimento in cassetta modulare con bussole esagonali ed inserti per avvitatura

~~€ 193,00~~ | **€ 126,00**



Modulari con i cassetti dei carrelli USAG!

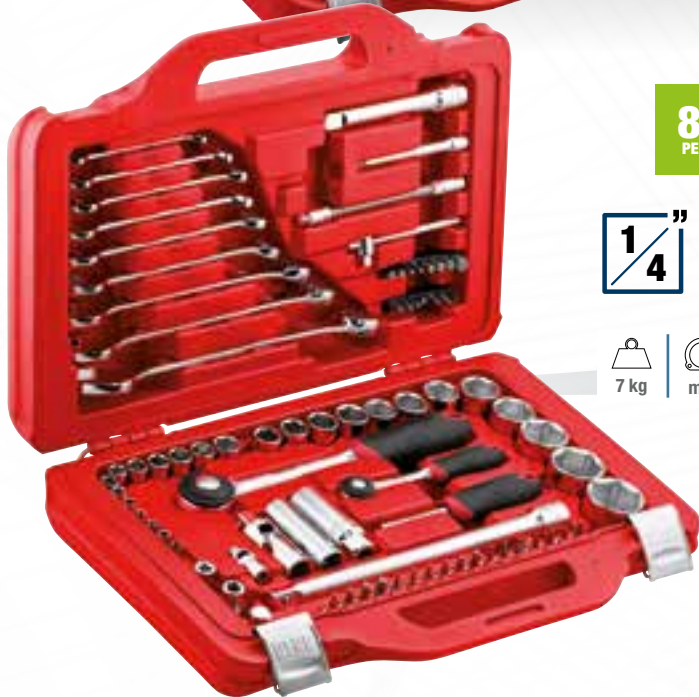

82
PEZZI

1/4" **1/2"**

7 kg | mm | 415
92
283



601 1/4-1/2 J82

Cod. U06010010

Assortimento in cassetta modulare con bussole esagonali e chiavi combinate

~~€ 292,00~~ | **€ 185,00**



16
PEZZI

285 J/B16

Cod. U02851740

Serie di 16 chiavi combinate

- Borsa avvolgibile in dotazione.

~~€ 117,00~~ | **€ 75,00**



6-7-8-9-10-11-12-13-14
15-16-17-18-19-22-24 mm

ESTRATTORI 458 E PER VITI ESAGONALI DANNEGGIATE



YouTube



9
PEZZI

458 E/B9
Cod. U04580313

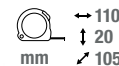

Set di estrattori per viti esagonali danneggiate

- In acciaio speciale con finitura fosfatata.
- Inclusa bussola portainseri 1/4-1/4".
- Fornito in astuccio di tessuto compatto.

DESCRIZIONE	ART./MISURA	PZ.
Estrattori per viti esagonali danneggiate 458 E 2-2,5-3-4-5-6-7-8		8
Bussola portainseri	684 1/4	1

~~€ 47,10~~ | **€ 33,00**

2-2,5-3-4-5-
6-7-8 mm

1/4 Bussola
portainseri

EFFICACE ANCHE SU VITI MOLTO DANNEGGIATE



1/4" 1/4

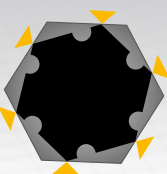

PROFILO ESCLUSIVO

Lo speciale design con cui sono realizzati gli inserti, permette di fare presa sugli esagoni incassati in qualunque condizione: intatti o completamente danneggiati.



VITI DANNEGGIATE

Quando una vite con esagono incassato si danneggia, non è più possibile svitarla con normali chiavi maschio esagonali. I nuovi estrattori 458 E permettono di svitare anche viti danneggiate fino al 98% del profilo esagonale.



20
PEZZI

458 S20
Cod. U04580312

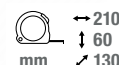

Assortimento di estrattori per viti e dadi esagonali danneggiati

- 458 B: bussole con attacco 3/8 o 1/2" e profilo elicoidale conico.
- 458 E: inserti con attacco 1/4" e profilo speciale esclusivo.
- Inclusa bussola portainseri 1/4-1/4".
- Cassetta in ABS ad alta resistenza.
- Modulo interno in spugna bicolore.

DESCRIZIONE	ART./MISURA	PZ.
Estrattori per viti e dadi esagonali danneggiate 458 B 8-10-11-12-13-14-15-16-17-18-19		11
Estrattori per viti esagonali danneggiate 458 E 2-2,5-3-4-5-6-7-8		8
Bussola portainseri	684 1/4	1

~~€ 195,00~~ | **€ 137,00**

KIT COMPLETO PER VITI E DADI DANNEGGIATI



1/4" 1/4

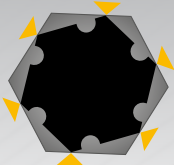

PROFILO ESCLUSIVO PER ESAGONI INCASSATI

Lo speciale design degli inserti permette di fare presa su esagoni incassati intatti o completamente danneggiati.



3/8" 1/2"

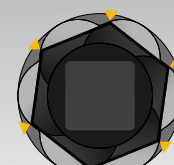

PROFILO ELICOIDALE PER DADI E VITI ESAGONALI

Le bussole elicoidali coniche garantiscono una presa esterna efficace su esagoni danneggiati.

454



Estrattori a due bracci per esterni

- Modello a bracci scorrevoli.
- Trave con esagono di supporto al serraggio.
- Bracci con unghiate ridotte.
- Vite in acciaio al carbonio.
- Corpo in acciaio al cromo vanadio.
- Esecuzione cromata e brunita.

CODICE	A	B	POTENZA	ESAGONO	PREZZO	PREZZO
U04540000	65 mm	70 mm	1,5 t	13 mm	€ 77,50	€ 54,50
U04540010	90 mm	110 mm	3 t	17 mm	€ 87,50	€ 61,00
U04540020	130 mm	110 mm	3 t	17 mm	€ 94,00	€ 66,00
U04540030	175 mm	165 mm	4 t	17 mm	€ 152,00	€ 106,00
U04540040	220 mm	165 mm	4 t	17 mm	€ 168,00	€ 118,00
U04540050	270 mm	220 mm	5 t	21 mm	€ 235,00	€ 165,00
U04540060	340 mm	220 mm	5 t	21 mm	€ 263,00	€ 184,00



4 PEZZI

451 N/S4

Cod. U04510100

Estrattore a tre bracci per esterni

- Modello a bracci autoserranti.
- Capacità: 7÷140 mm.
- Potenza: 3 ton.
- Spina di sicurezza.
- Vite di manovra con esagono da 18 mm.
- Possibilità di utilizzo a due bracci.
- Viti di manovra M16x2.

~~€ 322,70~~ | € 163,00

COMPRESSE
NEL PREZZO

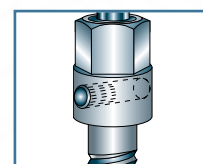

Spina di sicurezza:
utilizzo sicuro e qualità
dell'attrezzo preservata

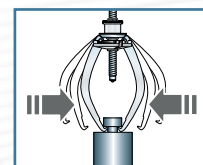

Autoserrante
Autocentrante

ESTRATTORI PER PRIGIONIERI E VITI SPEZZATE

Ø 6÷14
mm

25
PEZZI



460 A

Cod. U04600080

Serie di estrattori per prigionieri

- Fornita in cassetta in materiale plastico.

~~€ 155,00~~ | € 109,00

Ø 1÷6
mm

6
PEZZI



458 S6

Cod. U04580012

Serie di 6 estrattori conici

- Per la rimozione di viti o prigionieri spezzati che non offrono possibilità di presa.

~~€ 26,00~~ | € 18,20



CHIAVI DINAMOMETRICHE 810 SA - 811 SA CON LETTURA DIRETTA DELLA COPPIA DI SERRAGGIO.

CRICCHETTO REVERSIBILE
con meccanismo a 72 denti.



MECCANISMO A SCATTO
con molla di compressione.

IMPUGNATURA CONICA
in bimatériale e antiscivolo.



LETTURA DIRETTA
Il valore della coppia impostato è subito visibile.

REGOLAZIONE RAPIDA
Imposti il valore di coppia necessario ancora piú velocemente.

810 SA

ISO 6789



PRECISIONE
 $\pm 4\%$

3/8"

1/2"

**SERRAGGI
DESTORSI**

Chiave dinamometrica a lettura diretta con cricchetto reversibile

- Include certificato di taratura e dichiarazione REACH (SVHC).

ARTICOLO	CODICE	CAPACITÀ	☑	L (mm)	RISOL.	
810 SA 50	U08105002	10÷50	3/8"	350	0,25	€ 199,00 € 139,00
810 SA 100	U08105003	20÷100	1/2"	410	0,5	€ 199,00 € 139,00
810 SA 200	U08105005	40÷200	1/2"	475	1,0	€ 199,00 € 139,00
810 SA 340	U08105006	60÷340	1/2"	630	1,0	€ 228,00 € 160,00

811 SE

ISO 6789



PRECISIONE
 $\pm 4\%$

3/8"

1/2"

**SERRAGGI
DESTORSI
E SINISTRORSI**

Cricchetto
amovibile

Chiave dinamometrica a lettura diretta con cricchetto amovibile

- Include certificato di taratura e dichiarazione REACH (SVHC).

ARTICOLO	CODICE	CAPACITÀ	☑	☐	L (mm)	RISOL.	
811 SE 50	U08115012	10÷50	3/8"	9x12	370	0,25	€ 255,00 € 179,00
811 SE 100B	U08115013	20÷100	3/8"	9x12	430	0,5	€ 255,00 € 179,00
811 SE 100C	U08115015	20÷100	1/2"	9x12	430	0,5	€ 257,50 € 180,00
811 SE 200	U08115017	40÷200	1/2"	14x18	510	1,0	€ 262,00 € 183,00
811 SE 340	U08115018	60÷340	1/2"	14x18	665	1,0	€ 292,00 € 204,00

810 N

ISO 6789

Chiave dinamometrica con cricchetto reversibile

- Meccanismo a scatto con molla di compressione.
- Riarmo automatico: dopo lo scatto è subito pronta all'uso.
- Fornita con certificato di collaudo.

PRECISIONE
±4%

1/4"

ARTICOLO	CODICE	CAPACITÀ	□	L (mm)	RISOL.
----------	--------	----------	---	--------	--------

810 N 5	U08104000	1÷5	1/4"	197	0,05	€ 218,00 € 139,00
---------	------------------	-----	------	-----	------	----------------------------

810 N 25	U08104001	5 ÷ 25	1/4"	290	0,05	€ 218,00 € 139,00
----------	------------------	--------	------	-----	------	----------------------------

**SERRAGGI
DESTROSI**



811 NE

ISO 6789

Chiave dinamometrica con cricchetto reversibile amovibile

- Cricchetto amovibile e sostituibile con gli inserti della gamma 811.
- Meccanismo a scatto con molla di compressione.
- Riarmo automatico: dopo lo scatto è subito pronta all'uso.
- Fornita con certificato di collaudo.

PRECISIONE
±4%

1/4"

ARTICOLO	CODICE	CAPACITÀ	□	○	L (mm)	RISOL.
----------	--------	----------	---	---	--------	--------

811 NE 5	U08114009	1÷5	1/4"	9x12	185	0,05	€ 254,00 € 178,00
----------	------------------	-----	------	------	-----	------	----------------------------

811 NE 25	U08114010	5 ÷ 25	1/4"	9x12	300	0,05	€ 258,50 € 181,00
-----------	------------------	--------	------	------	-----	------	----------------------------

**SERRAGGI
DESTROSI
E SINISTRORSI**



Cricchetto
amovibile

812 N

ISO 6789

Chiavi dinamometriche con cricchetto reversibile

- Modelli a coppia regolabile per serraggi destrorsi e sinistrorsi con rotazione del cricchetto di 180°.
- Precisione ±4% del valore di coppia impostato.
- Scala di lettura in Nm.
- Meccanismo a scatto con molla di compressione.
- Riarmo automatico: dopo lo scatto è subito pronta all'uso.
- Blocco di sicurezza dopo la regolazione della coppia.
- Fornita in cassetta completa di certificato di collaudo.

PRECISIONE
±4%

3/4"

ARTICOLO	CODICE	CAPACITÀ	□	○
----------	--------	----------	---	---

812 N 600	U08120006	120 ÷ 600	3/4"	14x18	€ 1.005,00 € 704,00
-----------	------------------	-----------	------	-------	------------------------------

812 N 1000	U08120010	200 ÷ 1000	3/4"	-	€ 1.257,00 € 880,00
------------	------------------	------------	------	---	------------------------------

**SERRAGGI
DESTROSI
E SINISTRORSI**



824 A

ISO 6789

Giraviti dinamometrici

- Modello a coppia regolabile per serraggi destrorsi da utilizzare in abbinamento agli inserti della serie 660 o, tramite raccordo, alle chiavi a bussola della serie mano da 1/4".
- Scala di lettura in Nm.
- Disinnesto automatico al raggiungimento della coppia impostata.
- Riarmo automatico dopo 120°.
- Fornito con chiave di regolazione e certificato di collaudo.

1/4"

PRECISIONE
±6%

CODICE	CAPACITÀ	L (MM)	RISOL.
--------	----------	--------	--------

U08240004	0,5÷2,5	145	0,1	€ 241,00 € 169,00
------------------	---------	-----	-----	----------------------------

U08240006	2÷10	167	0,5	€ 246,00 € 172,00
------------------	------	-----	-----	----------------------------



Serraggio controllato

Serraggi controllati utilizzando cricchetti o chiavi a T

1/2"



YouTube

814 A

Dispositivo digitale coppia-angolo

- Permette serraggi coppia ed angolo di precisione digitale anche con utensili tradizionali.
- Per serraggi destrorsi e sinistrorsi.
- Scala di lettura in Nm/ft.lb/in-lb/kg.cm/gradi.
- Doppia indicazione: luminosa (LED) e sonora (buzzer) al raggiungimento del valore impostato.
- 9 valori di coppia o angolo preimpostabili.
- 50 misurazioni memorizzabili.
- In custodia di ABS con certificato di taratura.
- Alimentazione: 2 batterie AAA (include).

CODICE	CAPACITÀ	1/2"	RISOL.	
U08140003	27 - 135	1/2"	0,1	€ 251,00 € 176,00
U08140004	40 - 200	1/2"	0,1	€ 289,00 € 202,00
U08140005	68 - 340	1/2"	0,1	€ 351,00 € 246,00

Misurazione corretta dell'angolo in qualsiasi posizione

PRECISIONE
±2%



YouTube

831 A

Cod. U08310001

Goniometro digitale

- Permette serraggi angolari di precisione digitale in totale semplicità.
- Per serraggi destrorsi e sinistrorsi.
- Precisione angolo: +/- 2%.
- Scala: 0÷360°.
- Risoluzione: 0,1°.
- Doppia indicazione: luminosa (LED) e sonora (buzzer) al raggiungimento del valore impostato.
- 9 valori di angolo preimpostabili.
- 50 misurazioni memorizzabili.
- Fornito in custodia di ABS con certificato di taratura.
- Alimentazione: 2 batterie AAA (include nella confezione).

~~€ 182,00~~ | **€ 119,00**

Rapporto di moltiplicazione

1:3,4



Ingresso

Uscita

CAPACITÀ
1400
Nm

1/2"

3/4"

828 X4

Cod. U08280401

Moltiplicatore di coppia

- Modello compatto e leggero per interventi di manutenzione su veicoli industriali e macchine agricole.
- Fornito con leva di contrasto in custodia di nylon.
- Rapporto di trasmissione 4:1.
- Coppia max in ingresso: 400 Nm.

~~€ 829,00~~ | **€ 580,00**

FORBICE 207 E CON STRUTTURA INTEGRALE IN ACCIAIO INOX.



YouTube



**L'UNICA CON STRUTTURA
INTEGRALE IN ACCIAIO INOX**
resiste alla flessione fino a 180 kg.

**SPELLAFILI
INTEGRATO**



1. Spellatura.
2. Crimpatura.

**TAGLIACAVI SU
ENTRAMBE LE LAME**



Adatto per cavi
multipolari.

**LAMA MICRODENTATA
ANTISCIVOLO**



207 E

Cod. U02070006

Forbice professionale per elettricisti

€ 38,10 | **€ 26,70**



FORBICE 207 D

IL RIFERIMENTO PER GLI ELETTRICISTI.



**IMPUGNATURA
RESISTENTE ALLA
FLESSIONE FINO A 80 kg**
in tecnopolimero caricato vetro.

**ASOLE
MAGGIORATE**



50 mm²

LAME FLUIDE E ROBUSTE
In acciaio inox con
microdentatura e tagliacavi.

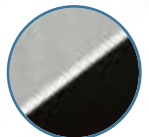

207 D

Cod. U02070008

Forbice professionale
per elettricisti

€ 25,00 | **€ 17,50**



YouTube



Ø 0,02÷10 mm²

146 B

Cod. U01460004

Pinza spellafili
automatica piegata a 90°

~~€ 114,00~~ | **€ 80,00**



Ø 4÷28 mm²

163

Cod. U01630001

Sguainacavi multifunzione

- Per il taglio circolare e longitudinale di cavi con rivestimento esterno in PVC.

~~€ 39,40~~ | **€ 27,60**



YouTube



0,5÷1 mm²
1,5÷2,5 mm²
4÷6 mm²

751

Cod. U07510002

Pinza per capicorda
preisolati

~~€ 58,50~~ | **€ 40,90**

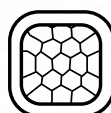

0,14÷10 mm²

753 KA

Cod. U07530004

Crimpatrice autoregolante per
puntalini a sezione quadra

~~€ 229,00~~ | **€ 160,00**



Isolati



Non isolati



9 PROFILI

Per armadi e
impianti tecnici

767

Cod. U07670001

Chiave a croce universale

~~€ 67,00~~ | **€ 46,90**



- ⊖ 1-1,2-1,5-1,8-2-2,5-3 mm
- ⊕ PH0-PH00-PH000
- ⊕ T5-T6-T7-T8-T9
- ⊕ TT10-TT15-TT20
- ⊕ PZ0-PZ1
- 0,9-1,3-1,5-2-2,5-3-4 mm
- ⊕ PT2-PT3-PT4
- ⊖ PT0-PT1

341 SH33

Cod. U03410019

Giravite di precisione portainseri
con 32 inserti

~~€ 38,30~~ | **€ 26,80**



33
PEZZI

SMART FUNCTION

Selezione automatica della
tensione AC/DC, resistenza
e frequenza

MAX
600 V

RMS



074 A

Cod. U00740001

Multimetro digitale compatto SMART

- Misurazione di AC/DC.
- Misurazioni di resistenza e continuità (suono acustico se resistenza circuito è inferiore 40 a Ω).
- Misurazioni frequenza.
- Misurazione corrente AC/DC con pinza amperometrica 076 P.



CAT III 600V

CARATTERISTICHE TECNICHE

Tensione continua DC	1÷600 mV÷V
Tensione alternata AC	1÷600 mV÷V
Resistenza	0÷10 Ω÷MΩ
Frequenza	3÷40 kHz
Tipo batterie (fornite)	2xAAA 1,5V

~~€ 140,00~~ | **€ 98,00**

Ideale sui terminali
dell'inverter delle
auto ibride ed
elettriche (CEI 11-27)

MAX
690 V



076 G

Cod. U00760006

Tester di tensione

- Rilevamento tensione/continuità.
- Identificazione fase/neutro.
- Test rotazione di fase.
- Segnalazione visiva e acustica.



CARATTERISTICHE TECNICHE

Tensione continua/alternata DC/AC	12÷690 mV÷V
Frequenza	50÷60 kHz
Tipo batteria (fornite)	1x9V

~~€ 128,00~~ | **€ 89,50**



007 MV

Cod. U00070035

Marsupio portautensili (vuoto)

- Tessuto ad altissima resistenza.
- Sistema di fissaggio alla cintura con chiusura in velcro.
- 4 tasche portautensili elasticizzate.
- Gancio porta nastro.

~~€ 20,30~~ | **€ 14,20**



007 MLV

Cod. U00070030

Marsupio portautensili con cintura (vuoto)

- Tessuto ad altissima resistenza.
- 6 tasche portautensili elasticizzate.
- Gancio porta nastro.
- Cintura regolabile da 80 a 120 cm.

~~€ 40,50~~ | **€ 28,30**

**FORNITA
IN CASSETTA**

Ø
**M4 - M5
M6 - M8**



995 CA
Cod. U09950008

Rivettatrice per inserti filettati

- Modello compatto con sistema di leve interno che garantisce meno sforzo all'operatore durante l'utilizzo.
- Fornita con 4 tiranti intercambiabili (M4-M5-M6-M8).
- Utilizzabile con rivetti in alluminio e acciaio (M4-M5-M6-M8) e acciaio inox (M4-M5).
- Corpo in lega leggera.
- Manici in materiale plastico.
- Fornita in valigetta di plastica (LxPxH: 320x175x50 mm) con vani portainseri filettati (non inclusi).

~~€ 84,00~~ | **€ 59,00**



235 mm



**PER RIVETTI
FILETTATI**
(non inclusi)



Serbatoio porta steli

330 mm

995 LA
Cod. U09950004

Rivettatrice dritta compatta

- Modello compatto con la stessa capacità di una rivettatrice lunga standard.
- Il sistema di leve interno riduce lo sforzo dell'operatore.
- Adatta a rivetti in alluminio ed acciaio
- 5 testine intercambiabili.
- Serbatoio amovibile per recupero steli.
- Corpo in lega leggera.
- Manici in materiale plastico.

COMPATTA E POTENTE

Solo 330 mm di lunghezza
20% di sforzo in meno
rispetto al modello standard.

~~€ 58,50~~ | **€ 40,90**

**-20%
DI SFORZO**

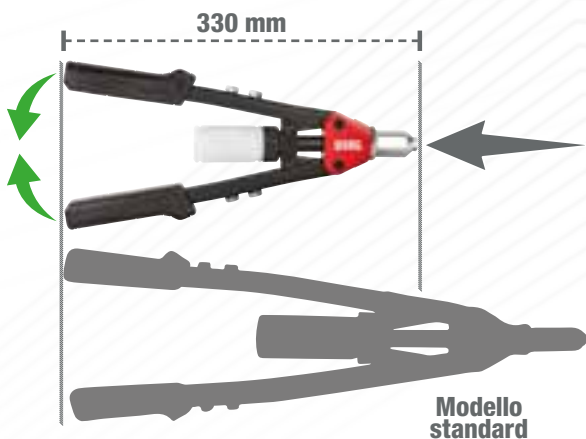

Modello standard



ALLUMINIO E ACCIAIO

- | | | |
|---------------------|---------------------|--------------------|
| • Ø 2,4 mm
3/32" | • Ø 4,0 mm
5/32" | • Ø 6,4 mm
1/4" |
| • Ø 3,2 mm
1/8" | • Ø 4,8 mm
3/16" | |



995 A

Cod. U09950001

Rivettatrice

- Corpo in lega leggera.
- Leva di pressione in lamiera d'acciaio imbutita.
- Molla di richiamo per l'apertura dei manici.
- Fornita con 3 testine intercambiabili e chiave di servizio.

~~€ 30,80~~ | **€ 21,60**

ALLUMINIO E ACCIAIO

- Ø 2,4 mm
3/32"
- Ø 3,2 mm
1/8"
- Ø 4,0 mm
5/32"
- Ø 4,8 mm
3/16" **SOLO
ALLUMINIO**



995 AF

Cod. U09950006

Rivettatrice con testa orientabile

- Testa orientabile liberamente a 360°.
- Adatta a rivetti in alluminio.
- 4 testine intercambiabili.
- Corpo in lega leggera.
- Manici in materiale plastico.
- Clip in metallo per blocco apertura.
- Chiave smontaggio testine in dotazione.

~~€ 33,10~~ | **€ 23,20**

ALLUMINIO

- Ø 2,4 mm
3/32"
- Ø 3,2 mm
1/8"
- Ø 4,0 mm
5/32"
- Ø 4,8 mm
3/16"



**TESTA
ORIENTABILE**

360°



926 A

Cod. U09260001

Rivettatrice oleopneumatica

- Fornita con quattro testine intercambiabili e chiave di servizio.

CARATTERISTICHE TECNICHE

Corsa	14 mm
Consumo medio aria	113 l/min
Pressione aria raccomandata	6,2 bar
Vibrazioni	1,3 m/s ²
Attacco aria	1/4"
Diametro interno tubo aria	10 mm

~~€ 228,00~~ | **€ 160,00**

ALLUMINIO E ACCIAIO

- Ø 2,4 mm
3/32"
- Ø 3,2 mm
1/8"
- Ø 4,0 mm
5/32"
- Ø 4,8 mm
3/16"



CE





305 N

Giratubi modello svedese con ganasce a 90° diritte

- Acciaio al cromo vanadio.

CODICE	CAPACITÀ	LUNGHEZZA	
U03050002	1"	40 mm	330 mm € 37,80 € 26,50
U03050003	1 1/2"	55 mm	420 mm € 50,50 € 35,30
U03050004	2"	67 mm	540 mm € 77,50 € 54,50
U03050005	3"	103 mm	690 mm € 116,00 € 81,00



7
PEZZI



9÷17 mm

307 A/S7

Cod. U03070001

Chiave per sottolavelli

- Per il montaggio di rubinetti e miscelatori con fissaggio a dado.
- Braccio cavo di 25 cm di lunghezza.
- Estremità cava per dadi esagonali di 13 mm.
- Adattatori forniti: 9,10,11,12,14,17 mm.

~~€ 41,50~~ | **€ 29,00**

317 K

Cod. U03170012

Tagliatubi per tubi in plastica

- Per il taglio di tubi in PEX, PEHD, PVC, PER.
- Modello a cremagliera per un'azione di taglio progressiva con il minimo sforzo.
- Corpo in lega leggera.
- Esecuzione verniciata.

~~€ 54,00~~ | **€ 37,80**



PLASTICA

Ø 35 mm Ø 1 3/8"

Inserto in acciaio filettato per uno scorrimento rapido



314 C

Cod. U03140032

Tagliatubi per tubi in rame e lega leggera

- Rulli di scorrimento scanalati per il taglio di tubi bordati.
- Sostituzione rapida della rotella senza bisogno di utensili.
- Spessore massimo tubo: 2 mm.

~~€ 34,90~~ | **€ 24,40**

Ø 3-30 mm Ø 1/8-1 1/8"



RAME

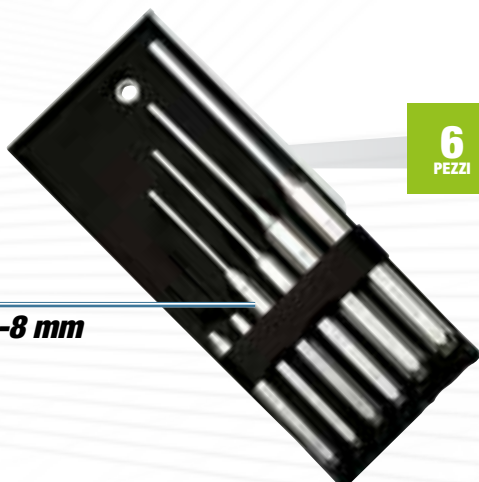

6
PEZZI

2-3-4-5-6-8 mm

367 SE6

Cod. U03670081

Serie di 6 cacciaspine

- 367/2x100-3x130-4x145-5x165-6x180-8x200 mm.
- Fornita in busta di plastica.
- Acciaio al cromo vanadio.
- Punte riportate e fosfatate per le misure da 2 e 3 mm.

~~€ 53,45~~ | **€ 37,40**



UNI 7784

376

Mazzuole

- Modello a tasselli intercambiabili in materiale plastico.
- Corpo in acciaio al carbonio.
- Manico in frassino.

CODICE	Ø TASSELLI	LUNGHEZZA	
U03760001	22 mm	250 mm	€ 13,30 € 9,30
U03760002	28 mm	275 mm	€ 16,10 € 11,30
U03760003	35 mm	300 mm	€ 20,40 € 14,30
U03760004	42 mm	325 mm	€ 27,50 € 19,30
U03760005	50 mm	350 mm	€ 37,70 € 26,40
U03760006	60 mm	380 mm	€ 54,50 € 38,10



UNI 7777 DIN 6475

382

Martelli per meccanici

- Modello tedesco a testa quadra piana e penna simmetrica.
- Manico in frassino.

CODICE	PESO TESTA	LUNGHEZZA	
U03820002	100 g	260 mm	€ 11,00 € 7,70
U03820004	200 g	280 mm	€ 11,50 € 8,05
U03820006	300 g	300 mm	€ 12,70 € 8,90
U03820007	400 g	310 mm	€ 15,10 € 10,60
U03820008	500 g	320 mm	€ 17,00 € 11,90
U03820009	600 g	330 mm	€ 19,60 € 13,70
U03820010	800 g	350 mm	€ 22,70 € 15,90
U03820011	1000 g	360 mm	€ 25,60 € 17,90
U03820013	1500 g	380 mm	€ 34,20 € 23,90
U03820014	2000 g	400 mm	€ 44,30 € 31,00

Testa in acciaio al carbonio forgiata e sottoposta a trattamento termico differenziato per garantire una maggiore durata ed evitare scheggiature o ricalcature della superficie battente.

DIN 338

HSS-G

14
PEZZI



988 LA/S14

Cod. U09880070

Assortimento di punte e maschi

- Ø punte: 2,5-3,3-4,2-5,0-6,8-8,5-10,2 mm.
- M maschi: 3x0,5-4x0,7-5x0,8-6x1-8x1,25-10x1,5-12x1,75 mm.

~~€ 83,00~~ | **€ 58,00**

DIN 338

HSS-G

19
PEZZI



988 MA/S19

Cod. U09880073

Assortimento di punte

- Ø punte: 1,0-1,5-2,0-2,5-3,0-3,5-4,0-4,5-5,0-5,5-6,0-6,5-7,0-7,5-8,0-8,5-9,0-9,5-10,0 mm.

~~€ 50,50~~ | **€ 35,30**

DIN 338

HSS-G

25
PEZZI



988 MA/S25

Cod. U09880074

Assortimento di punte

- Ø punte: 1,0-1,5-2,0-2,5-3,0-3,5-4,0-4,5-5,0-5,5-6,0-6,5-7,0-7,5-8,0-8,5-9,0-9,5-10,0-10,5-11,0-11,5-12,0-12,5-13,0 mm.

~~€ 100,00~~ | **€ 70,00**



HSS

3
PEZZI



988 D/S3

Cod. U09880020

Serie di 3 frese a scalino

ART.	Ø SCALINI	Ø CODOLO	LUNG.
988 D1	4-5-6-7-8-9-10-11-12 mm	6 mm	65 mm
988 D2	4-6-8-10-12-14-16-18-20 mm	8 mm	75 mm
988 D3	4-6-8-10-12-14-16-18-20-22-24-26-28-30 mm	10 mm	100 mm

~~€ 185,00~~ | **€ 130,00**

HSS

12
PEZZI



988 G/S12

Cod. U09880100

Serie di 10 seghe a tazza bimetalliche

- Ø 19-22-25-29-35-38-44-51-57-64 mm.
- Profondità di taglio max: 38 mm.

~~€ 189,00~~ | **€ 132,00**

HSS

10
PEZZI



Ø 6 mm



988 E/S10

Cod. U09880062

Frese rotative in metallo duro

- N°8 pezzi (Ø 10 e 12 forme EA-EC-EF-EG).
- N°2 pezzi (Ø 12 forme ED-EM).

~~€ 468,00~~ | **€ 217,00**

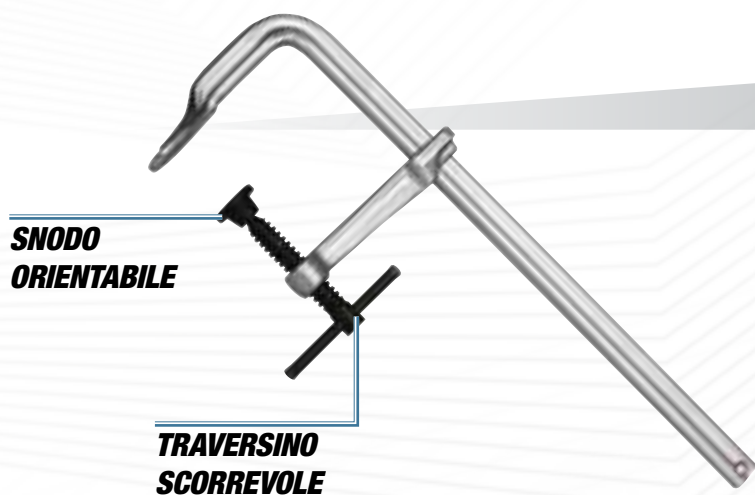

997 A

Strettoio a vite

- Corpo e asta scorrevole in acciaio forgiato.

CODICE	APERTURA	SEZIONE	PESO		
U09970002	160 mm	16x7,5 mm	0,5 kg	€ 26,30	€ 18,40
U09970003	200 mm	19,5x9,5 mm	0,9 kg	€ 32,80	€ 23,00
U09970004	250 mm	22x10,5 mm	1,2 kg	€ 39,30	€ 27,50
U09970005	300 mm	25x12 mm	1,8 kg	€ 50,00	€ 35,00
U09970006	400 mm	25x12 mm	1,9 kg	€ 52,50	€ 36,80
U09970007	500 mm	25x12 mm	2,1 kg	€ 57,00	€ 39,90
U09970008	600 mm	25x12 mm	2,3 kg	€ 61,50	€ 43,00
U09970009	800 mm	27x13 mm	3,3 kg	€ 81,00	€ 56,50
U09970010	1000 mm	27x13 mm	3,7 kg	€ 91,50	€ 64,00



997 B

Strettoio rapido a leva

- Regolazione e sgancio rapidi tramite leva e pulsante integrato.
- Corpo e asta scorrevole in acciaio forgiato.

CODICE	APERTURA	SEZIONE	PESO		
U09970013	120 mm	13,5x6,5 mm	0,7 kg	€ 50,00	€ 35,00
U09970014	160 mm	16x7,5 mm	1 kg	€ 55,00	€ 38,50
U09970015	200 mm	19,5x9,5 mm	1,3 kg	€ 67,00	€ 46,90
U09970016	250 mm	22x10,5 mm	1,9 kg	€ 77,50	€ 54,50
U09970017	300 mm	25x12 mm	2,7 kg	€ 95,00	€ 66,50
U09970018	400 mm	25x12 mm	2,8 kg	€ 99,50	€ 69,50
U09970019	500 mm	25x12 mm	3 kg	€ 105,00	€ 73,50



200 S

Cod. U02000002

Seghetto

- Anima in acciaio rivestita in materiale plastico antiscivolo ed antiurto
- Fornito con lama al cobalto mod. 200 C24

~~€ 33,50~~ | **€ 23,40**

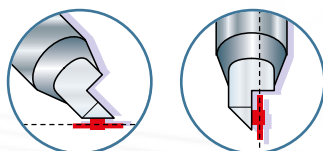

SISTEMA DI TENSIONAMENTO DELLA LAMA
integrato nell'impugnatura

**PASSO GROSSO
METRICO ISO
DESTRORSO**

NEW

**40
PEZZI**



618 MF1

Cod. U06180050

4,7 kg | mm | 425
83
395

Assortimento in cassetta di lamiera con maschi e filiere

Maschi:

- Assortimento con serie di 3 maschi, sgrossatore, intermedio, finitore, per metalli duri.
- Acciaio rapido HSS.
- Filetti rettificati e senza spalla.
- Passo grosso metrico ISO destrorso.
- Qualità lavorazione 6H.

Filieri:

- Acciaio rapido HSS al cromo vanadio trattato a 62/64 HRc (234 daN/mm²).
- Passo grosso metrico ISO destrorso.
- Vite conica che consente una regolazione perfetta del diametro di filettatura.

DESCRIZIONE	ART/MISURA	PZ.
Maschi	M3 - M4 - M5 - M6 - M7 - M8 - M9 - M10 - M12	27
Filieri	M3 - M4 - M5 - M6 - M7 - M8 - M9 - M10 - M12	9
Giramaschi	618 M 1 - 2	2
Porta filiere	832.1" - 832.1"1/2	2

~~€ 333,00~~ | **€ 233,00**

**PASSO GROSSO
METRICO ISO
DESTRORSO**

NEW

**29
PEZZI**



618 MF2

Cod. U06180051

2,6 kg | mm | 430
60
205

Assortimento in cassetta di lamiera con maschi

- Assortimento con serie di 3 maschi, sgrossatore, intermedio, finitore, per metalli duri.
- Acciaio rapido HSS.
- Filetti rettificati e senza spalla.
- Passo grosso metrico ISO destrorso.
- Qualità lavorazione 6H.

DESCRIZIONE	ART/MISURA	PZ.
Maschi	M3 - M4 - M5 - M6 - M7 - M8 - M9 - M10 - M12	27
Giramaschi	618 M 1 - 2	2

~~€ 198,00~~ | **€ 139,00**

NEW

**10
PEZZI**



282 S10

Cod. U02820200

2 kg | mm | 330
215

Assortimento in cassetta di ABS con chiavi a compasso per ghiera a nasello tondo e quadro

- Chiavi a compasso per ghiera con fori e con intagli.
- Le chiavi si regolano agendo sulla vite centrale.
- Naselli amovibili.
- Diametri ghiera: da 20 a 100mm.
- Finitura cromata satinata.
- Cassetta in ABS ad alta resistenza con sistema di chiusura a clip.

DESCRIZIONE	MISURA	PZ.
Naselli tondi	(d) 2,5 - 3 - 4 - 5 - 6 - 7 - 8 - 9 mm	4
Naselli quadri	(a) 4 - 5 - 6 - 8 mm	4

~~€ 152,00~~ | **€ 106,00**

PER GHIERE CON DIAMETRI DA 20 A 100 mm

Ghiere con fori
sulla parte superiore

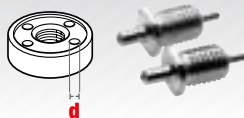

Ghiere con intagli
sulla parte superiore

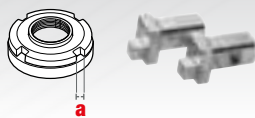

**TUTTI I PRODOTTI DELLA LINEA USAG 493
SONO FABBRICATI IN ITALIA E RISPETTANO ELEVATI
STANDARD DI SICUREZZA E DURATA**



EN 1492-1



493 A

Fascia di sollevamento asola-asola doppio strato

- Coefficiente di sicurezza 7:1.
- Abbinamento colori e portate a norme EN 1492-1.

CODICE	PORTATA	LUNG.	PREZZO	PREZZO
U04930002	1t	2m	€ 11,00	€ 7,70
U04930003	1t	3m	€ 16,30	€ 11,40
U04930004	1t	4m	€ 20,60	€ 14,40
U04930005	1t	5m	€ 25,10	€ 17,60
U04930006	1t	6m	€ 30,80	€ 21,60
U04930012	2t	2m	€ 21,20	€ 14,80
U04930013	2t	3m	€ 29,00	€ 20,30
U04930014	2t	4m	€ 36,00	€ 25,20
U04930015	2t	5m	€ 44,80	€ 31,40
U04930016	2t	6m	€ 52,50	€ 36,80
U04930022	3t	2m	€ 31,80	€ 22,30
U04930023	3t	3m	€ 43,70	€ 30,60
U04930024	3t	4m	€ 54,00	€ 37,80
U04930025	3t	5m	€ 65,00	€ 45,50
U04930026	3t	6m	€ 77,50	€ 54,50



EN 1492-1



493 B

Fune di sollevamento tonda ad anello chiuso

- Struttura con guaina rinforzata antiusura.
- Coefficiente di sicurezza 7:1.
- Abbinamento colori e portate a norme EN 1492-1.

CODICE	PORTATA	LUNG.	PREZZO	PREZZO
U04930052	1t	1m	€ 9,10	€ 6,35
U04930053	1t	1,5m	€ 12,20	€ 8,55
U04930054	1t	2m	€ 17,30	€ 12,10
U04930055	1t	2,5m	€ 20,90	€ 14,60
U04930056	1t	3m	€ 25,00	€ 17,50
U04930062	2t	1m	€ 12,60	€ 8,80
U04930063	2t	1,5m	€ 18,00	€ 12,60
U04930064	2t	2m	€ 23,50	€ 16,40
U04930065	2t	2,5m	€ 29,60	€ 20,70
U04930066	2t	3m	€ 34,40	€ 24,10
U04930072	3t	1m	€ 17,30	€ 12,10
U04930073	3t	1,5m	€ 25,90	€ 18,10
U04930074	3t	2m	€ 31,00	€ 21,70
U04930075	3t	2,5m	€ 38,10	€ 26,70
U04930076	3t	3m	€ 44,80	€ 31,40



EN 12195-2

493 C

Cinghie per ancoraggi

- Larghezza nastro 35÷50 mm.
- Tenditore a cricchetto da 35÷50 mm.
- Carico di ancoraggio 1000÷2000 N.
- Gancio ad uncino per i codici U04930102, U04930103, U04930104.
- Gancio a sponda a due dita per il codice U04930106.
- Norma di riferimento EN 12195-2.

CODICE	CARICO	NASTRO	PREZZO	PREZZO
U04930102	1000 N	35 mm x 4 m	€ 33,20	€ 23,20
U04930103	1000 N	35 mm x 6 m	€ 37,20	€ 26,00
U04930104	2000 N	50 mm x 8 m	€ 39,30	€ 27,50
U04930106	2000 N	50 mm x 10 m	€ 39,30	€ 27,50



SMD
LED



IP20



Lampada: 5 h
Torchia: 9 h



4,5 h



IK07



Li-ion

889 RD

Cod. U08890035

Lampada di ispezione a LED

~~€ 106,00~~ | **€ 74,00**



YouTube

DOPPIA FUNZIONE



LAMPADA



TORCIA

RICARICABILE



COB
LED



IP54



2,5/5 h



4 h



IK06



Li-Poly

889 SA

Cod. U08890019

Lampada ispezione a LED
extra sottile ad alta luminosità

~~€ 126,00~~ | **€ 88,00**



YouTube



RICARICABILE

USB



SMD
LED



2/5 h



Li-ion



IP54



6 h

889 TR

Cod. U08890073

Torcia LED in alluminio ricaricabile

~~€ 71,50~~ | **€ 50,00**

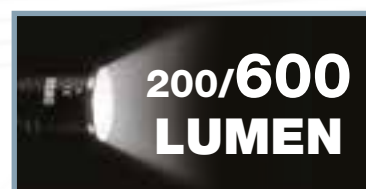

RICARICABILE

USB

360°



Lampada
COB LED

889 RP

Cod. U08890045

Torcia
SMD LED

Lampada a LED ricaricabile compatta

~~€ 64,00~~ | **€ 44,80**

Lampada: 3h
Torcia: 10h

IP20

4,5 h

Li-ion

DOPPIA FUNZIONE



LAMPADA



TORCIA

RICARICABILE USB



YouTube

180°



COB
LED

889 RT

Cod. U08890038

IP67

Faretto a LED ricaricabile - certificato IP67

2,5 h

~~€ 276,00~~ | **€ 193,00**

1 = 8 h
2 = 4 h
3 = 2,5 h

IK07

Li-ion

3 LIVELLI DI LUMINOSITÀ



MAX
**1500
LUMEN**

**FUNZIONA
CON 0
SENZA CAVO!**

Cavo da 5
metri incluso.

500, 1000 e 1500 lumen
con un semplice tocco.



YouTube

Base
magnetica



COB
LED

889 LTE

Cod. U08890014

IP54

Lampada frontale a LED

24/6,5 h

~~€ 60,50~~ | **€ 32,50**

3xAAA



50/200
LUMEN



ORIENTABILE



**CINTURINO
ANTISCIVOLO**



**SENSORE DI
MOVIMENTO**

MANUTENZIONE AUTO IBRIDE ED ELETTRICHE

LE OPERAZIONI PRINCIPALI PER L'AUTOFFICINA:



YouTube



MESSA IN SICUREZZA

Escludere la tensione dell'impianto elettrico per poter effettuare la manutenzione del veicolo.

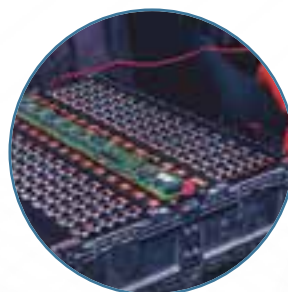

MANUTENZIONE CELLE BATTERIE

Sostituire le singole celle usurate per ricondizionare il pacco batterie.

LO SAPEVI CHE...

- A.** Auto ibride ed elettriche montano impianti elettrici con **tensioni elevate e potenzialmente pericolose (oltre 200 V in CC e 600 V in CA).**
- B.** Gli interventi di manutenzione su auto ibride ed elettriche sono equivalenti a **lavori elettrici su sistemi di categoria 0 e 1**, come definito nel D. Lgs 81/08 - normativa tecnica di riferimento CEI 11-27.
- C.** È necessario utilizzare attrezzatura **con isolamento 1000 V come: utensili, guanti, sovraguanti e tappetino** per garantire la sicurezza durante le operazioni.



DISPOSITIVI DI PROTEZIONE INDIVIDUALE

NEW



099 TG

Cod. U00990216

Verificatore pneumatico per guanti dielettrici

€ 350,00 | **€ 245,00**

NEW



099 FS

Cod. U00990217

Visiera protettiva

€ 63,00 | **€ 44,10**

NEW



099 G

Cod. U00990218

Guanti isolanti 1000 V Taglia 10

€ 195,00 | **€ 137,00**

NEW



099 L

Cod. U00990219

Lucchetto isolato

€ 61,00 | **€ 42,70**

NEW

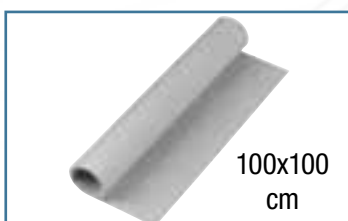

099 H

Cod. U00990211

Tappeto isolante 1000V

€ 174,00 | **€ 122,00**



099 BG

Cod. U00990221

Fioletto di salvataggio

€ 210,00 | **€ 147,00**

USAG
FOR HYBRID
AND ELECTRIC



IL NECESSARIO PER LA MESSA IN SICUREZZA



8
PEZZI

3/8"

↔ 435
↓ 70
mm ↗ 270

098 3/8" HYB8

Cod. U00980508



Assortimento in cassetta di ABS per MESSA IN SICUREZZA AUTO IBRIDE ed ELETTRICHE

- Cassetta in ABS ad alta resistenza con sistema di chiusura rapida.

DESCRIZIONE	ART./MISURA	PZ.
Chiavi a bussola con bocca poligonale 1000 V	098 3/8" 8-10-12	3
Cricchetto reversibile 1000 V	098 A 3/8"	1
Prolunga 1000 V	098 B 3/8" 150	1
Pinza 1000 V	081 EX 200	1
Giravite per viti a intaglio 1000 V	091 1x5,5x125	1
Giravite per viti a impronta PHILLIPS® 1000 V	091 PH 2x125	1

~~€ 346,70~~ | **€ 243,00**

ASSORTIMENTO PER MESSA IN SICUREZZA E MANUTENZIONE CELLE BATTERIE



519 M 098HYB8

519 M 098HYB11

076 G

20
PEZZI



495 098HYB

Cod. U04958010

Assortimento per MESSA IN SICUREZZA e MANUTENZIONE CELLE BATTERIE - 1 cassetto

DESCRIZIONE	ART	PZ
Bussole poligonali 1000 V (8-10-12 mm), cricchetto 1000 V (098 A 3/8), prolunga 3/8" 1000 V, giraviti 1000 V e pinza 1000 V	519 M 098HYB8	8
Bussole poligonali 1000 V (11-13-14 mm), chiavi poligonali 1000 V (8-10-12-13-14 mm) e giraviti 1000 V	519 M 098HYB11	11
Tester di tensione	076 G	1

~~€ 833,90~~ | **€ 545,00**



**5 CASSETTI
3 MODULI**



20
PEZZI



516 ST5HYA-S

Cod. U05168024

Carrello START per MESSA IN SICUREZZA e MANUTENZIONE CELLE BATTERIE - 1 cassetto

DESCRIZIONE	ART	PZ
Bussole poligonali 1000 V (8-10-12 mm), cricchetto 1000 V (098 A 3/8), prolunga 3/8" 1000 V, giraviti 1000 V e pinza 1000 V	519 M 098HYB8	8
Bussole poligonali 1000 V (11-13-14 mm), chiavi poligonali 1000 V (8-10-12-13-14 mm) e giraviti 1000 V	519 M 098HYB11	11
Tester di tensione	076 G	1

~~€ 1.375,90~~ | **€ 963,00**





YouTube

TRASFORMATORE INTEGRATO

Nessun alimentatore esterno.



12 V

1200 A

BATTERIA AGM
(Absorbed Glass Mat)



1613 RA12

Cod. U16130019

Avviatore portatile 12V

- Scocca antiurto in ABS.
- Idoneo anche per batterie sigillate.
- Pinze diritte.
- Fornito con cavo di ricarica.

~~€ 550,00~~ | **€ 385,00**

PULSANTE TEST

Indicazione semaforica a LED dello stato di carica della batteria.

3500 A

LUNGHEZZA CAVI 155 cm



VANO PER CAVO RICARICA E ACCENDISIGARI



FUSIBILE ESTERNO

Protezione da sovracorrente fino a 300A. Facile da sostituire in caso di sovraccarico.

CONNETTORE POSTERIORE PER SELEZIONE VOLTAGGIO



12 V
24 V

1400 A
700 A

BATTERIA AGM
(Absorbed Glass Mat)



1613 AGM12-24

Cod. U16130013

Avviatore professionale portatile 12V-24V

- Scocca antiurto in ABS.
- Protezione da sovratensione.
- Idoneo anche per batterie sigillate.
- Pinze inclinate.
- Fornito con caricatore di rete e cavo presa accendisigari.

~~€ 1.247,00~~ | **€ 873,00**

FUSIBILE ESTERNO

Protezione da sovracorrente fino a 300A.

24V - 1860 A

LUNGHEZZA CAVI 155 cm



VOLTMETRO

per indicazione dello stato di carica della batteria interna.

PER BATTERIE 6÷12 V

Anche per sistema
Start & Stop



890 K

Cod. U08901000

Tester digitale per batterie con stampante

€ 658,00 | **€ 461,00**

E-OBD OBD-II

⚠ IMPORTANTE ⚠

Utilizzare questo accessorio
solo con avviatori da 12V.



1613 OBD

Cod. U16130003

Cavo OBD salva-memorie 12 V

€ 51,50 | **€ 36,00**

12 V

12 V



1612 BA12

Cod. U16120006

Proteggi centraline 12 V

- Protegge le centraline durante le operazioni di saldatura, avviamento con caricabatterie o avviatori, avviamento con cavi.

€ 81,50 | **€ 57,00**

24 V



1612 BA24

Cod. U16120007

Proteggi centraline 24 V

- Protegge le centraline durante le operazioni di saldatura, avviamento con caricabatterie o avviatori, avviamento con cavi.

€ 81,50 | **€ 57,00**

Range di misura: -60÷625°
Rapporto ottico: 16:1



Compatibile
con termocoppia K.

1651

Cod. U16510001

Termometro digitale ad infrarossi

€ 177,00 | **€ 124,00**



YouTube



22
PEZZI



1881 S22

Cod. U18810082

Kit universale per lo smontaggio e il montaggio
delle ghiera pulegge alternatori

- Fornito in cassetta di plastica

€ 131,00 | **€ 91,50**

KIT UNIVERSALE PER LA RIMOZIONE DI DADI E VITI ANTIFURTO



10
PEZZI

272 DS

Cod. U02720001

Kit estrazione dadi e viti antifurto

- Non danneggia il cerchio in lega.
- Punte speciali al carburo di tungsteno in grado di forare qualsiasi tipo di materiale (lubrificare con olio da taglio ad ogni utilizzo).
- Bussole coniche per centraggio/estrazione super sottili per accedere su ogni tipo di cerchio in lega.

€ 286,40 | € 200,00

YouTube
VIDEO
TUTORIAL



ESTRATTORE PROGETTATO PER RESISTERE 150 Nm: IDEALE PER VITI BMW.

Dadi e viti antifurto standard: svita velocemente con le bussole coniche.



Dadi e viti con anello girevole: fora ed estrai in sicurezza con gli utensili speciali.



447 T

Cod. U04470101

Smonta ammortizzatori pneumatico

- Ideale per autovetture.
- Sistema di autolivellamento dei bracci superiori: adatto anche a molle coniche e disassate.
- Boccole autolubrificanti: nessuna operazione di lubrificazione e/o ingrassaggio sulle colonne di scorrimento.
- Fornito con due staffe inferiori 447 TC1 (78÷130 mm) e 447 TC2 (105÷182 mm), morsa 447 TA e morsetti superiori universali 447 TB1.



YouTube

**POTENZA DI
COMPRESSIONE
735 kg (6 bar),
1226 kg (10 bar).**

CARATTERISTICHE TECNICHE

Potenza compressione	735 kg (6 bar) - 1226 kg (10 bar)
Pressione di esercizio	6÷10 bar
Corsa del pistone	420 mm
Cilindro	Doppio in lega d'alluminio e resina al nylon



€ 1.862,00 | € 1.303,00

CONFORMITÀ ALLA DIRETTIVA MACCHINE

Gli smontammortizzatori pneumatici USAG sono progettati per rispondere pienamente alla Direttiva Macchine 2006/42/CE. Alcune funzionalità della macchina sono state impostate perché l'operatore possa lavorare in totale sicurezza:

- Protezione frontale di sicurezza.
- Dispositivo di arresto del pistone in caso di apertura della protezione frontale.
- Velocità limitata: sempre inferiore ai 10 cm/sec.
- Sistema di blocco delle ganasce e del pistone in caso di interruzione dell'alimentazione dell'aria.



270 C/C3
Cod. U02700106

Assortimento in cassetta modulare con bussole macchina per cerchi in lega con protezione in téflon

~~€ 56,90~~ | **€ 39,80**

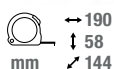

1 1/2"



Mercedes-Benz

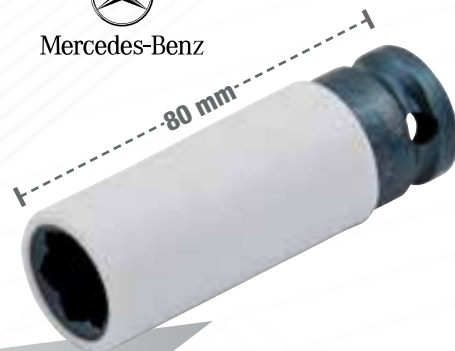
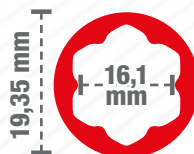

270 BM
Cod. U02700140

Chiave a bussola per dadi ruota Mercedes

- Adatta per i modelli: Classe C e GLK (W204), Classe E (W211, W212, W207), Classe SLK (W172), Classe ML (W164, W166), Classe CL (W216), Classe S (W221, W222).

~~€ 13,00~~ | **€ 9,10**



RIVESTIMENTO PROTETTIVO

Lo speciale rivestimento in teflon riduce il rischio di danneggiamento quando si opera su cerchi in lega di alluminio.



CODICE COLORE

ogni misura è facilmente riconoscibile grazie al colore del rivestimento in teflon.



PRESSIONE REGOLABILE FINO A 4 BAR



Fornito con:

- guarnizioni di ricambio,
- 1 tappo multidiametro 44-45-46 mm (2847 N11).
- 1 contenitore di recupero olio.

2847/3
Cod. U28470084

12 V

Spurgatore per circuito freni

- Permette di cambiare, riempire, spurgare i circuiti dei freni di autovetture e veicoli industriali.
- Apparecchio progettato esclusivamente per liquidi freno tipo DOT 3, DOT 4, DOT 5.1. No LHM.
- Pressione regolabile fino a 4 bar.
- Arresto automatico al 10% del serbatoio (1 L).
- Alimentazione 12 V tramite cavi batteria.
- Vano posteriore accessori.
- Ruote integrate e maniglione per un facile trasporto.

~~€ 1.470,00~~ | **€ 1.029,00**

CARATTERISTICHE TECNICHE

Sistema di manovra del liquido	Pompa peristaltica (nessun contatto diretto pompa liquido, nessuna pressione aria sul liquido)
Alimentazione	12 V (morsetti batteria)
Capacità serbatoio	10 litri
Limitatore di pressione	4 bar
Tubo a spirale	4 m (elastico)
Cavo di alimentazione	4 m

2847 N4
Cod. U28470098Q

Tappo adattatore universale

- Per spurgafreni 2847/3.

~~€ 172,00~~ | **€ 120,00**



30,5 kg mm \leftrightarrow 615 mm \nearrow 344

3
TON **30,5**
kg

CE

3t



2550 A

Cod. U25500001

Sollevatore idraulico 3T per auto e veicoli commerciali

- Struttura in acciaio.
- Polivalente e compatto.
- Portata elevata per utilizzo su auto, fuoristrada e furgoni.
- Sistema a doppia pompa per sollevare più velocemente la vettura.
- Dotato di comando di discesa manuale.
- Valvola di spurgo dell'aria, per evitare il pericolo di over-carico.
- Impugnatura con gomma antiurto.
- Ruote in poliuretano.

~~€ 324,00~~ | **€ 219,00**



32,5 kg mm \leftrightarrow 762 mm \nearrow 350

2
TON **32,5**
kg

CE

2t

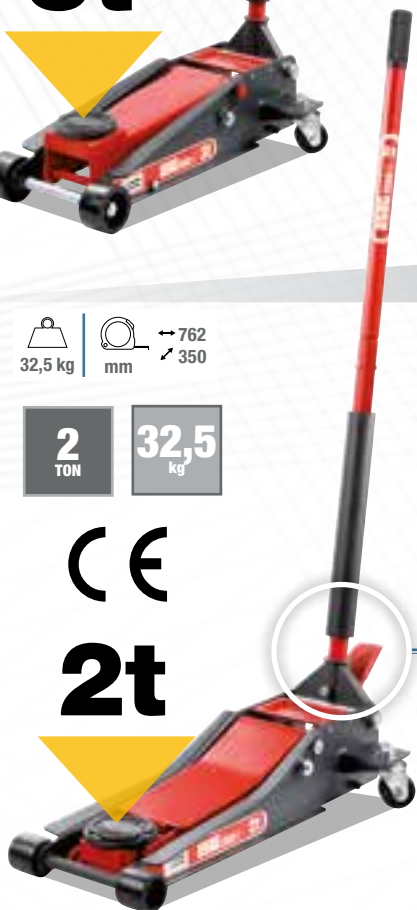

2550 B

Cod. U25500002

Sollevatore idraulico 2T

- Struttura in acciaio.
- Per utilizzo in spazi ridotti.
- Sistema a doppia pompa per sollevare più velocemente la vettura.
- Dotato di pedale di avvicinamento.
- Dotato di comando di discesa manuale.
- Valvola di spurgo dell'aria, per evitare il pericolo di over-carico.
- Impugnatura con gomma antiurto.
- Ruote in poliuretano.

~~€ 458,00~~ | **€ 321,00**

Pedale di avvicinamento

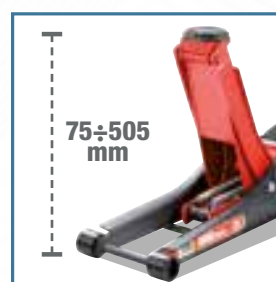

2
PEZZI



1950 C

Coppia colonnette

- Altezza regolabile tramite meccanismo dentato con rilascio a leva.
- Perno di bloccaggio con catena.
- 1950 C/3: modello regolabile a 10 posizioni.
- 1950 C/6: modello regolabile a 13 posizioni.

CODICE	PORTATA	H MAX	H MIN	DIMENSIONI	PESO
U19501001	3 t	427 mm	300 mm	207x188 mm	7 kg
U19501002	6 t	620 mm	400 mm	285x250 mm	14 kg

€ 90,00 | **€ 63,00**

€ 130,00 | **€ 91,00**

SELEZIONE PRODOTTI TRUCK



445 B

Cod. U04450015

Chiave per filtri olio - grandi dimensioni

- Modello regolabile a 8 posizioni.
- Ganasce con dentatura triangolare per una maggiore presa sul filtro.
- Corpo in acciaio forgiato.
- Impugnature in PVC.
- Esecuzione brunita.

~~€ 84,00~~ | **€ 59,00**

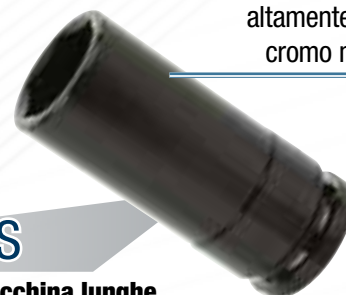

Acciaio speciale altamente legato al cromo molibdeno

235 3/4 MLS

Chiavi a bussola macchina lunghe a parete sottile con bocca esagonale

- Ideali per lo smontaggio di mozzi TRUCK come TRILEX, IVECO, MERCEDES, MAN, DAF, MAGIRUS, DEUTZ, RENAULT, SCANIA, ASTRA, VOLVO.

CODICE	MISURA	Ø ESTERNO	LUNGHEZZA	PREZZO
U02350272	27 mm	39 mm	100 mm	€ 42,30 € 29,60
U02350273	30 mm	43 mm	100 mm	€ 43,40 € 30,40
U02350274	32 mm	45 mm	100 mm	€ 44,20 € 30,90
U02350275	33 mm	48 mm	100 mm	€ 48,70 € 34,10



32 mm



by **FACOM**

446 RT

Cod. U04461206

Chiave a tazza per filtri olio TRUCK

- Specifiche per montare e smontare filtri olio RENAULT e VOLVO TRUCKS.
- Corpo in alluminio.

~~€ 39,00~~ | **€ 27,30**



Dimensioni profilo Ø106 mm x 15 lati



Ø MAX 36 mm

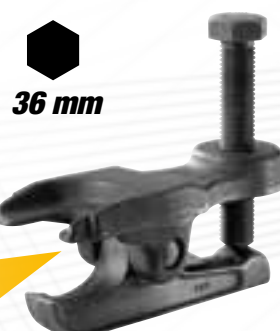

36 mm

by **FACOM**

449 IDA

Cod. U04490019

Estrattore per snodi sferici

- Azionamento meccanico.
- Per l'estrazione degli snodi sferici e delle sospensioni di mezzi pesanti.

~~€ 141,00~~ | **€ 98,50**

22 mm

Ø MAX 23 mm



22 mm

Ø MAX 25 mm



Ø MAX 42 mm



449 TA

Cod. U04490010

Estrattore per snodi sferici mezzi pesanti

- Per l'estrazione dei perni a snodo sferico sui tiranti trasversali dello sterzo.

~~€ 115,00~~ | **€ 80,50**

449 TB

Cod. U04490015

Estrattore per snodi sferici mezzi pesanti

- Per l'estrazione dei perni a snodo sferico sui tiranti trasversali dello sterzo.

~~€ 115,00~~ | **€ 80,50**

449 TC

Cod. U04490021

Estrattore per snodi sferici mezzi pesanti

- Per l'estrazione dei perni a snodo sferico sui tiranti trasversali dello sterzo.

~~€ 256,00~~ | **€ 179,00**

CHIAVE FILTRI OLIO 443 N CON REGOLAZIONE AUTOMATICA DEL NASTRO.



YouTube

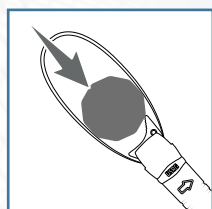

**SERRAGGIO AUTOMATICO
DEL NASTRO**

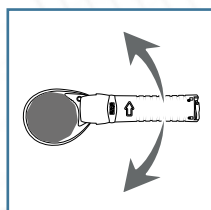

EFFETTO CRICCHETTO

Rapidità d'uso anche in spazi ridotti.

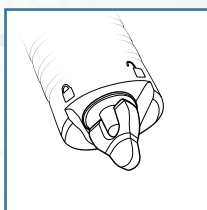

**LEVA DI INCREMENTO
POTENZA SERRAGGIO**



443 N

Cod. U04430005

Chiave automatica a ripresa rapida per filtri olio (autovetture)

~~€ 99,50~~ | **€ 69,50**



**66÷105
mm**

443 NC

Cod. U04430007

Chiave automatica a ripresa rapida per filtri olio (veicoli industriali)

~~€ 115,00~~ | **€ 80,50**



**106÷150
mm**



**2
PEZZI**

3/8"



YouTube

446 E/SE2

Cod. U04460015

Serie di 2 chiavi autoserranti per filtri olio
• 446 E/60÷80-80÷100 mm

~~€ 156,00~~ | **€ 109,00**



446 DA/SE6

Cod. U04461104

Serie di 6 chiavi per coperchio filtro olio

- 1 chiave 14 tacche Ø 76 mm.
- 1 chiave 14 tacche Ø 102 mm.
- 1 chiave 16 tacche Ø 76 mm.
- 1 chiave 16 tacche Ø 88 mm.
- 1 chiave 18 tacche Ø 66 mm.
- 1 chiave 18 tacche Ø 96 mm.
- Quadro di manovra 3/8".

~~€ 203,00~~ | **€ 142,00**

**6
PEZZI**

3/8"

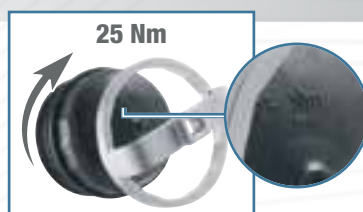

Permettono il riserraggio alla coppia originale di smontaggio (valore indicato sulla campana di plastica)

In alluminio

3/8"

27 mm

- Dimensioni profilo: Ø 64,5 mm x 14 lati.
- Dimensioni d'ingombro (Øxh): 80x49 mm.



2 PEZZI

3/8"

27 mm

- Dimensioni profilo: Ø 64,5 mm x 14 lati.
- Dimensioni d'ingombro (Øxh): 86x49 mm.



446 DT/S2

Cod. U04461203

Serie di 2 chiavi per coperchi filtro olio modelli giapponesi

- Riduce i rischi di danneggiamento dei coperchi filtri.
- Utilizzabili anche in serraggio con chiave dinamometrica.
- Corpo in alluminio fosfatato.

~~€ 57,00~~ | **€ 39,90**



Inquadra il QR code per scaricare la tabella delle applicazioni o vai su usag.it



Specifiche per smontare i coperchi dei filtri olio a immersione dei motori Toyota, Lexus, Daihatsu, Subaru



NEW

446 DC

Chiavi a tazza per coperchi filtri olio

- Riduce i rischi di danneggiamento dei coperchi filtri olio.
- Profilo esagonale.

CODICE	MISURA	PREZZO
U04461224	24	€ 10,00 € 7,00
U04461227	27	€ 10,00 € 7,00
U04461230	30	€ 12,00 € 8,40
U04461232	32	€ 12,00 € 8,40
U04461236	36	€ 15,00 € 10,50
U04461238	38	€ 15,00 € 10,50

by **FACOM**

Attacco per il recuperatore d'olio



VASCHETTA RACCOGLI OLIO INTEGRATA

263/S16

Cod. U02631400

16 PEZZI

Kit per tappi olio

- Bussole magnetiche.
- 1 chiave snodata con coppetta.
- 2 inserti ○ 8-10 mm.
- 6 inserti ○ 8-10-12-13-14-17 mm.
- 6 bussole ● 13-14-17-18-19-21 mm.
- 1 inserto ○ T45.

3/8"

~~€ 179,00~~ | **€ 125,00**



Indicatore temperatura a LED



2 MODALITÀ:

- 1 250 l/min - 50°÷400°C
- 2 500 l/min - 50°÷600°C

MAX
600
GRADI

2000
WATT

391

Cod. U03910001

Pistola termica digitale

- Modello elettronico con controllo della temperatura e del volume d'aria mediante display digitale.
- Possibilità di impostazione dei programmi.
- Dotata di sistema di raffreddamento.

€ 202,00 | **€ 99,00**



**ACCESSORI
INCLUSI**

NEW

5
PEZZI



324 LTX/SH5

Cod. U03240500

Serie di 5 giraviti lunghi con impronta TORX®

- 324 LTX T20x275 - T25x275 - T27x275 - T30x275 - T40x275

€ 77,50 | **€ 54,50**



NEW

2
PEZZI



115 CL/SE2

Cod. U01150022

Serie di 2 pinze lunghe becchi dritti e piegati a 45°

- Ideale per la presa di pezzi e parti in posizioni di difficile accesso.
- Becchi a punta con superficie di presa zigrinata.
- Lunghe fino al 70% in più di una normale pinza a becchi lunghi.
- Doppio snodo per la massima accessibilità grazie al ridotto ingombro.
- Impugnature rivestite in materiale antiscivolo.

€ 77,00 | **€ 54,00**



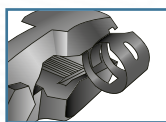

2 in 1

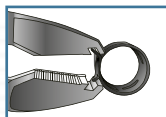

871 D

Cod. U08710001



Pinza per anelli stringitubo a presa frontale/laterale

- Possibilità di aggancio frontale o laterale.
- Ganasce con superficie di presa zigrinata.

~~€ 51,50~~ | **€ 36,00**

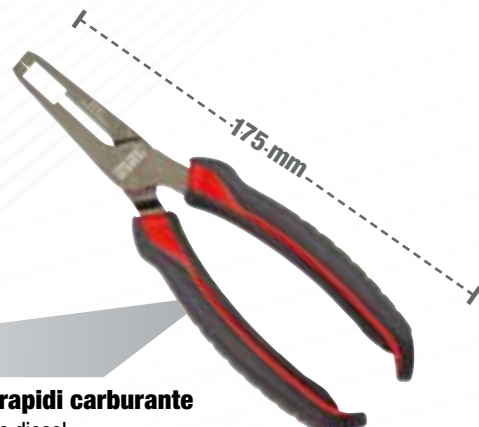

870 C

Cod. U08700006

Pinza per raccordi rapidi carburante

- Per veicoli a benzina e diesel.
- Impugnature ergonomiche bimateriali.

~~€ 62,00~~ | **€ 43,40**

3 posizioni di lavoro



871 C

Cod. U08719005P

Pinza per fascette automatiche CLIC

- Testa triassiale per lavorare in tutte le posizioni.
- Permette di aprire o chiudere le fascette automatiche presenti sui circuiti del carburante, dei collettori d'aspirazione e dei circuiti idraulici.

~~€ 73,00~~ | **€ 51,00**



468 M

Utensile a percussione per anelli di tenuta e guarnizioni

- Semplifica l'inserimento di anelli di supporto esterni per cuscinetti obliqui.
- Asse, sede dei cuscinetti e anelli di tenuta non vengono danneggiati.
- Ghiera regolabile in 3 posizioni.
- Impugnatura in acciaio.

CODICE	CAPACITÀ	LUNGHEZZA	
U04680150	9,5÷50 mm	176 mm	€ 102,00 € 71,50
U04680151	18÷90 mm	210 mm	€ 128,00 € 89,50

9
PEZZI

Due spazzole metalliche
Ø 20mm e 25mm



885 F

Cod. U08850004

Kit pulizia iniettori

- Ideale per la pulizia del condotto degli iniettori montati su motori common rail.

~~€ 163,00~~ | **€ 114,00**

6
PEZZI

1/2"



884 C/S6

Cod. U08841000

Serie di 6 chiavi per raccordi tubi iniettori

- Per montaggio/smontaggio dei raccordi tubi iniettori.
- Lunghezza: 98 mm.
- Misure: 12-14-16-17-18-19 mm.

~~€ 122,00~~ | **€ 85,50**

12
PEZZI

UNIVERSALE PER AIRBAG

426 SAB
Cod. U04260010

Kit manutenzione Airbag

- Adatto per i seguenti modelli di auto: VW Bora, Golf 4, Jetta, Lupo, New Beetle, Passat B5, Polo; Audi A4, A6; BMW; Mercedes-Benz; Opel; Renault; Seat; Skoda Fabia, Octavia, Superb.

~~€ 75,50~~ | **€ 53,00**



4
PEZZI

Per separare i carter della cinghia di distribuzione, testata motore, cinghia di trasmissione etc.

426 D/S4
Cod. U04260005

Kit di 4 scalpelli separatori in plastica

~~€ 25,90~~ | **€ 18,10**



4
PEZZI

Per la rimozione di contrappesi, silicone, modanature etc

426 C/S4
Cod. U04260007

Kit di 4 raschietti multiuso in plastica

~~€ 32,30~~ | **€ 22,60**



5
PEZZI

Per la rimozione di modanature, pioli, parti di cruscotto, rivestimenti portiere, etc.

426 B/S5
Cod. U04260006

Kit di 5 utensili per componenti in plastica

~~€ 30,30~~ | **€ 21,20**

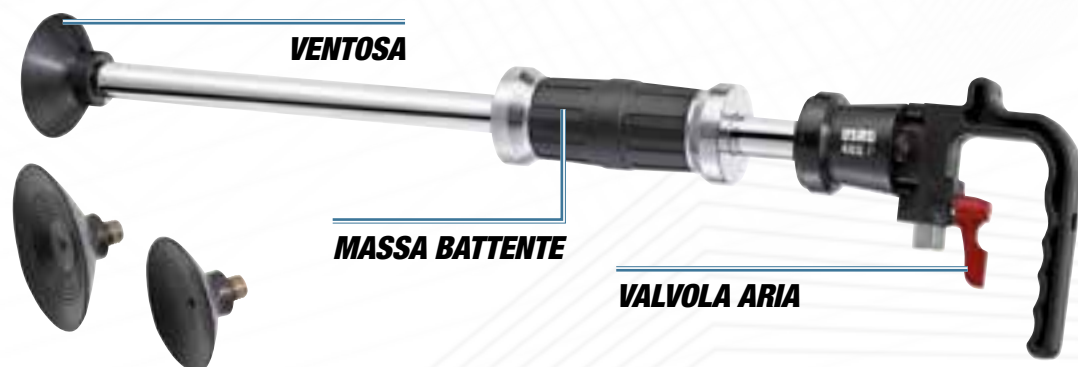

CARATTERISTICHE TECNICHE

Attacco filettatura	M18
Livello sonoro	78 Db
Lunghezza totale	610 mm
Peso	4 Kg
Pressione di esercizio	6,2 bar
Attacco filettato	1/4"

400 P
Cod. U04000010

Aspiratore pneumatico ammaccature

- Ideale per eliminare ammaccature da parti scatoiate senza la necessità di rivernicare.
- Fornito con 3 ventose (Ø 75-100-125 mm), in valigetta in materiale plastico dotata di maniglia per il trasporto e clip di chiusura.

~~€ 194,00~~ | **€ 136,00**



9,5
Litri



4,1 kg | 230 mm | 627 | 302



1785 B

Cod. U17850005

Aspiratore liquidi manuale e pneumatico

CARATTERISTICHE TECNICHE

Pressione aria raccomandata	5÷8 bar
Range temperatura liquidi aspirati	1÷100 °C
Capacità serbatoio	9,5 litri
Accessori contenuti	1 tubo principale 1500 x Ø 16 mm - 4 tubi di aspirazione: 400 x Ø 9,5 mm, 700 x Ø 6 mm, 850 x Ø 7, 700 x Ø 6

~~€ 218,00~~ | **€ 153,00**



4,6 kg | 1.030 mm | 480 | 115



150 kg

2000 A

Cod. U20000100

Letto sottococca 6 ruote

- Cuscino poggiatesta in vinile resistente agli idrocarburi.
- Struttura in materiale plastico resistente agli idrocarburi, lavabile.
- Due vaschette porta utensili laterali.
- Altezza massima da terra: 115mm.
- Fornito con 6 ruote in gomma pivotanti Ø 80mm (da montare).

~~€ 117,00~~ | **€ 82,00**

250
coprisedili



3781 E

Cod. U38000075

Coprisedili

- In polietilene
- In formato doppio, riveste tutto il sedile compresa la parte posteriore
- Spessore: 13 micron
- Dimensioni: 70x165 cm

~~€ 114,00~~ | **€ 80,00**

250 tappetini

1 bobina
coprivolante



250 coprisedili

3781 A

Cod. U38000072

Set service

- Fornito con espositore murale.

~~€ 407,00~~ | **€ 217,00**

3781 C

Cod. U38000073

Tappetino per officina

- Salvamoquette in carta di tipo assorbente
- Dimensioni: 45x35 cm

~~€ 112,00~~ | **€ 78,50**



3781 D

Cod. U38000074

Coprivolante

- Per la protezione del volante durante la permanenza del veicolo in officina
- Materiale: film estensibile
- Dotate di srotolatore in plastica

~~€ 51,00~~ | **€ 31,50**



ILLUMINAZIONE A LED

1/2"

1.898 Nm → 2,2 kg



YouTube

CARTER IN LEGA DI MAGNESIO



TOP DI GAMMA

943 PC1 1/2"

Cod. U09430001

Avvitatore ad impulsi in magnesio

CARATTERISTICHE TECNICHE			
Attacco quadro	1/2"	Pressione aria raccomandata	6,2 bar
Capacità bullone	M20	Pressione sonora	94 ±3 dB(A)
Coppia massima	1.898 Nm	Potenza sonora	105 ±3 dB(A)
Coppia di lavoro	320÷460 Nm	Vibrazioni	6,4 m/s ²
Impulsi al minuto	1200	Attacco aria	1/4"
Velocità a vuoto	6.500 giri/min	Diametro interno tubo aria	10 mm
Consumo medio aria	172 l/min	Peso	2,2 kg

~~€ 479,00~~ | **€ 329,00**

IL RIFERIMENTO

CARTER IN LEGA DI MAGNESIO

1/2"

1.600 Nm → 2 kg



YouTube



929 PC1 1/2"

Cod. U09290001

Avvitatore ad impulsi in magnesio

CARATTERISTICHE TECNICHE			
Attacco quadro	1/2"	Pressione aria raccomandata	6,2 bar
Capacità bullone	M16	Pressione sonora	93 ±3 dB(A)
Coppia massima	1.600 Nm	Potenza sonora	104 ±3 dB(A)
Coppia di lavoro	280÷440 Nm	Vibrazioni	6,2 m/s ²
Impulsi al minuto	1.300	Attacco aria	1/4"
Velocità a vuoto	7.000 giri/min	Diametro interno tubo aria	10 mm
Consumo medio aria	172 l/min	Peso	2,0 kg

~~€ 369,00~~ | **€ 249,00**

EXTRA COMPATTO



1/2"

861 Nm → 1,3 kg



YouTube

942 PC3 1/2"

Cod. U09420012

Avvitatore ad impulsi - extra compatto

CARATTERISTICHE TECNICHE			
Attacco quadro	1/2"	Pressione aria raccomandata	6,2 bar
Capacità bullone	M16	Pressione sonora	91,1±3 dB(A)
Coppia massima	861 Nm	Potenza sonora	108,1±3 dB(A)
Coppia di lavoro	150÷220 Nm	Vibrazioni	9,57 m/s ²
Impulsi al minuto	1650	Attacco aria	1/4"
Velocità a vuoto	10.000 giri/min	Diametro interno tubo aria	10 mm
Consumo medio aria	127 l/min	Peso	1,3 kg

~~€ 238,00~~ | **€ 169,00**

YouTube



Modulare con i cassetti dei carrelli USAG

943 PC1/C12

Cod. U09430005

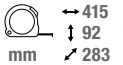

1/2"

Assortimento in cassetta modulare con avvitatore ad impulsi e bussole macchina

12 PEZZI

DESCRIZIONE	ART./MISURA	PZ.
Avvitatore ad impulsi in magnesio	943 PC1 1/2	1
Chiavi a bussola macchina con bocca esagonale	235 1/2 M/ 10-13-17-18-19-22-24-27-30-32 mm	10
Spina di tenuta	235 MCA/4-6	2
Anello di sicurezza	235 MDA/4-6	2
Prolunghe macchina	236 1/2 M/125	1

~~€ 642,90~~ | **€ 399,00**



Modulare con i cassetti dei carrelli USAG

929 PC1/C12

Cod. U09290005

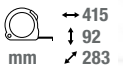

1/2"

Assortimento in cassetta modulare con avvitatore ad impulsi e bussole macchina

12 PEZZI

DESCRIZIONE	ART./MISURA	PZ.
Avvitatore ad impulsi in magnesio	929 PC1 1/2	1
Chiavi a bussola macchina con bocca esagonale	235 1/2 M/ 10-13-17-18-19-22-24-27-30-32 mm	10
Spina di tenuta	235 MCA/4-6	2
Anello di sicurezza	235 MDA/4-6	2
Prolunghe macchina	236 1/2 M/125	1

~~€ 532,90~~ | **€ 325,00**



Modulare con i cassetti dei carrelli USAG

942 PC3/C7

Cod. U09420015

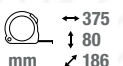

1/2"

Assortimento in cassetta modulare con avvitatore ad impulsi e bussole macchina

7 PEZZI

DESCRIZIONE	ART./MISURA	PZ.
Avvitatore ad impulsi - extra compatto	942 PC3 1/2	1
Chiavi a bussola macchina con bocca esagonale	235 1/2 M/ 13-17-19-21-22-24 mm	6
Spina di tenuta	235 MCA/4	1
Anello di sicurezza	235 MDA/4	1

~~€ 318,95~~ | **€ 217,00**

ILLUMINAZIONE A LED

CARTER IN LEGA DI MAGNESIO

CORPO IN ALLUMINIO

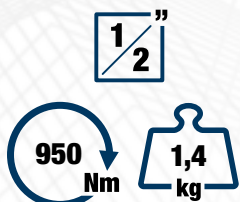

943 PC2 1/2"

Cod. U09430002

Avvitatore ad impulsi in magnesio con LED - Extra compatto

CARATTERISTICHE TECNICHE

Attacco quadro	1/2"	Pressione aria raccomandata	6,2 bar
Capacità bullone	M16	Pressione sonora	95±3 dB(A)
Coppia massima	950 Nm	Potenza sonora	107±3 dB(A)
Coppia di lavoro	200÷270 Nm	Vibrazioni	3,9 m/s ²
Impulsi al minuto	1400	Attacco aria	1/4"
Velocità a vuoto	10.000 giri/min	Diametro interno tubo aria	10 mm
Consumo medio aria	167 l/min	Peso	1,4 kg

~~€ 408,00~~ | **€ 286,00**

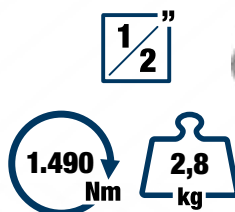

928 AC1 1/2"

Cod. U09280014

Avvitatore ad impulsi in alluminio

CARATTERISTICHE TECNICHE

Attacco quadro	1/2"	Pressione sonora	90 ±3 dB(A)
Capacità bullone	M16	Potenza sonora	101 ±3 dB(A)
Coppia massima	1.490 Nm	Vibrazioni	5,2 m/s ²
Coppia di lavoro	135÷380 Nm	Attacco aria	1/4"
Impulsi al minuto	1.120	Diametro interno tubo aria	10 mm
Velocità a vuoto	6.500 giri/min	Pressione aria raccomandata	6,2 bar
Consumo medio aria	147 l/min	Peso	2,8 kg

~~€ 292,00~~ | **€ 199,00**

3/8"

TESTA PIATTA E COMPATTA

ideale per l'uso in spazi ristretti.

54 Nm

0,5 kg



913 PB2 3/8"

Cod. U09130011

Cricchetto in materiale composito

CARATTERISTICHE TECNICHE

Attacco quadro	3/8"	Pressione sonora	92±3 dB(A)
Capacità bullone	M10	Potenza sonora	103±3 dB(A)
Coppia massima	54 Nm	Vibrazioni	3,9 m/s ²
Velocità a vuoto	300 giri/min	Attacco aria	1/4"
Consumo medio aria	110 l/min	Diametro interno tubo aria	6 mm
Pressione aria raccomandata	6,2 bar	Peso	0,5 kg

~~€ 154,00~~ | **€ 108,00**

1/2"

136 Nm

1,2 kg



913 PC2 1/2"

Cod. U09130017

Cricchetto in materiale composito

CARATTERISTICHE TECNICHE

Attacco quadro	1/2"	Pressione sonora	99±3 dB(A)
Capacità bullone	M10	Potenza sonora	110±3 dB(A)
Coppia massima	136 Nm	Vibrazioni	9,1 m/s ²
Velocità a vuoto	280 giri/min	Attacco aria	1/4"
Consumo medio aria	113 l/min	Diametro interno tubo aria	10 mm
Pressione aria raccomandata	6,2 bar	Peso	1,2 kg

~~€ 233,00~~ | **€ 163,00**

CARTER IN LEGA DI TITANIO

3/4"

2.115 Nm
3,8 kg



942 PD1 3/4"

Cod. U09420004

Avvitatore ad impulsi in titanio

CARATTERISTICHE TECNICHE

Attacco quadro	3/4"	Pressione aria raccomandata	6,2 bar
Capacità bullone	M27	Pressione sonora	97,8±3 dB(A)
Coppia massima	2.115 Nm	Potenza sonora	108,8±3 dB(A)
Coppia di lavoro	500÷800 Nm	Vibrazioni	5,06 m/s ²
Impulsi al minuto	950	Attacco aria	3/8"
Velocità a vuoto	5.300 giri/min	Diametro interno tubo aria	10 mm
Consumo medio aria	200 l/min	Peso	3,8 kg

~~€ 856,00~~ | **€ 599,00**

3/4"

1.700 Nm
5,6 kg



928 D1 3/4"

Cod. U09280015

Avvitatore ad impulsi in alluminio

CARATTERISTICHE TECNICHE

Attacco quadro	3/4"	Pressione aria raccomandata	6,2 bar
Capacità bullone	M24	Pressione sonora	98,4±3 dB(A)
Coppia massima	1.700 Nm	Potenza sonora	109,4±3 dB(A)
Coppia di lavoro	500÷1.050 Nm	Vibrazioni	9,1 m/s ²
Impulsi al minuto	790	Attacco aria	3/8"
Velocità a vuoto	5.700 giri/min	Diametro interno tubo aria	13 mm
Consumo medio aria	193 l/min	Peso	5,6 kg

~~€ 779,00~~ | **€ 545,00**

1"

3.390 Nm
6,8 kg



942 PE1 1"

Cod. U09420005

Avvitatore ad impulsi in materiale composito

CARATTERISTICHE TECNICHE

Attacco quadro	1"	Pressione aria raccomandata	6,2 bar
Capacità bullone	M38	Pressione sonora	100,9 ±3 dB(A)
Coppia massima	3.390 Nm	Potenza sonora	111,9 ±3 dB(A)
Coppia di lavoro	203÷1.627 Nm	Vibrazioni	10,6 m/s ²
Impulsi al minuto	900	Attacco aria	1/2"
Velocità a vuoto	5.000 giri/min	Diametro interno tubo aria	19 mm
Consumo medio aria	400 l/min	Peso	6,8 kg

~~€ 1.044,00~~ | **€ 731,00**

173 mm

1"

3.390 Nm
9 kg

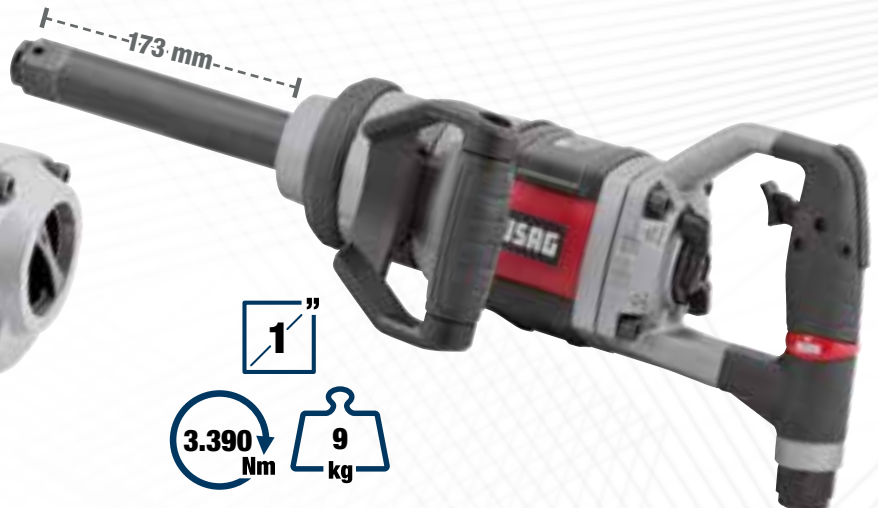

942 PEL2 1"

Cod. U09420007

Avvitatore reversibile in linea in materiale composito

CARATTERISTICHE TECNICHE

Attacco quadro	1"	Pressione aria raccomandata	6,2 bar
Capacità bullone	M38	Pressione sonora	105 ±3 dB(A)
Coppia massima	3.390 Nm	Potenza sonora	116 ±3 dB(A)
Coppia di lavoro	203÷1.627 Nm	Vibrazioni	15,6 m/s ²
Impulsi al minuto	1000	Attacco aria	1/2"
Velocità a vuoto	5.000 giri/min	Diametro interno tubo aria	19 mm
Consumo medio aria	480 l/min	Peso	9 kg

~~€ 1.091,00~~ | **€ 764,00**

152
mm

5
mm

105
l/min

COMPATTA
-221 mm-



920 AN1
Cod. U09200011

Levigatrice roto-orbitale

CARATTERISTICHE TECNICHE

Potenza	0,19 Kw
Capacità disco	Ø 152 mm
Orbita	5 mm
Orbite al minuto	10.000 giri/min
Consumo medio aria	105 l/min
Pressione aria raccomandata	6,2 bar
Pressione sonora	78,9±3 dB(A)
Potenza sonora	79,9±3 dB(A)
Vibrazioni	11,8 m/s ²
Attacco aria	1/4"
Diametro interno tubo aria	10 mm
Peso	0,8 kg



€ 310,00 | **€ 217,00**

125
mm

750 W

12.000
Giri/min



921 A4
Cod. U09210012

Smerigliatrice angolare

CARATTERISTICHE TECNICHE

Diametro disco	Ø 125 mm
Diametro attacco disco	Ø 24 mm
Potenza	0,75 Kw
Velocità a vuoto	12.000 giri/min
Consumo medio aria	120 l/min
Pressione aria raccomandata	6,2 bar
Pressione sonora	86±3 dB(A)
Potenza sonora	94±3 dB(A)
Vibrazioni	2,5 m/s ²
Attacco aria	1/4"
Peso	1,9 Kg



€ 310,00 | **€ 217,00**

10.000
Cicli/min

230
l/min

800
g



923 A
Cod. U09230001

Seghetto alternativo

CARATTERISTICHE TECNICHE

Cicli al minuto	10.000
Consumo medio aria	230 l/min
Attacco aria	1/4"
Pressione aria raccomandata	6,2 bar
Diametro interno tubo aria	10 mm
Pressione sonora	83,5±3 dB(A)
Potenza sonora	94,5±3 dB(A)
Vibrazioni	17,1 m/s ²
Peso	800 g



€ 252,00 | **€ 176,00**

CAVO 16 m
Ø 10 mm

939 C1
Cod. U09390004

Avvolgitubo aria

CARATTERISTICHE TECNICHE

Lunghezza tubo	16 m
Diametro interno tubo	10 mm
Pressione max di utilizzo	15 bar
Raccordo in uscita	3/8"
Dimensioni (inclusa staffa)	450x400x230 mm
Peso	8 kg



€ 309,00 | **€ 216,00**

20.000 Giri/min



921 B1

Cod. U09210015

Smerigliatrice dritta

CARATTERISTICHE TECNICHE

Consumo medio aria	113 l/min	Vibrazioni	2,5 m/s ²
Pressione aria raccomandata	6,2 bar	Attacco aria	1/4"
Pressione sonora	93,3±3 dB(A)	Diametro interno tubo aria	10 mm
Potenza sonora	104,3±3 dB(A)	Peso	660 g

~~€ 108,00~~ | **€ 59,00**

30.000 Giri/min



922 B1

Cod. U09220001

Smerigliatrice dritta

CARATTERISTICHE TECNICHE

Consumo medio aria	76 l/min	Vibrazioni	2,42 m/s ²
Pressione aria raccomandata	6,2 bar	Attacco aria	1/4"
Pressione sonora	84,8±3 dB(A)	Diametro interno tubo aria	10 mm
Potenza sonora	99,5±3 dB(A)	Peso	440 g

~~€ 108,00~~ | **€ 75,50**

25.000 Giri/min



922 B2

Cod. U09220002

Smerigliatrice dritta alta potenza

CARATTERISTICHE TECNICHE

Consumo medio aria	113 l/min	Vibrazioni	1,86 m/s ²
Pressione aria raccomandata	6,2 bar	Attacco aria	1/4"
Pressione sonora	85,4±3 dB(A)	Diametro interno tubo aria	10 mm
Potenza sonora	99,8±3 dB(A)	Peso	675 g

~~€ 123,00~~ | **€ 86,00**

23.000 Giri/min



90°



922 BP1

Cod. U09220004

Smerigliatrice angolare 90°

CARATTERISTICHE TECNICHE

Consumo medio aria	76 l/min	Vibrazioni	4,54 m/s ²
Pressione aria raccomandata	6,2 bar	Attacco aria	1/4"
Pressione sonora	85,9±3 dB(A)	Diametro interno tubo aria	10 mm
Potenza sonora	96,9±3 dB(A)	Peso	555 g

~~€ 154,00~~ | **€ 108,00**

28.000 Giri/min



922 BL1

Cod. U09220003

Smerigliatrice mandrino lungo

CARATTERISTICHE TECNICHE

Consumo medio aria	76 l/min	Vibrazioni	2,86 m/s ²
Pressione aria raccomandata	6,2 bar	Attacco aria	1/4"
Pressione sonora	83,3±3 dB(A)	Diametro interno tubo aria	10 mm
Potenza sonora	94,3±3 dB(A)	Peso	664 g

~~€ 154,00~~ | **€ 108,00**



6 PEZZI

1 1/2"

↔ 210
↓ 60
mm ↗ 130

233 1/2" MNTX/C6

Cod. U02332514



Assortimento in cassetta di ABS con bussole per viti con impronta TORX®

DESCRIZIONE	ART./MISURA	PZ.
Chiavi a bussola macchina per viti con impronta TORX®	233 1/2 MNTX T30-T40-T45-T50-T55-T60	6

~~€ 103,40~~ | **€ 72,50**



16 PEZZI

1 1/2"

↔ 210
↓ 60
mm ↗ 130

687 1/2" C16

Cod. U06870100



Assortimento in cassetta di ABS con inserti macchina

DESCRIZIONE	ART./MISURA	PZ.
Portainseriti	685 6 1/2	1
Portainseriti	685 8 5/16	1
Inserti esagono maschio 1/2	687 E 6-7-8-10-12-14	6
Inserti TORX 1/2	687 TX T30-T40-T45-T50-T55	5
Inserti PHILLIPS 5/16	686 PH 2-3-4	3

~~€ 183,65~~ | **€ 99,00**



6 PEZZI

3 3/4"

↔ 210
↓ 60
mm ↗ 130

688 3/4" MD6

Cod. U06880010



Assortimento in cassetta di ABS con inserti macchina

DESCRIZIONE	ART./MISURA	PZ.
Portainseriti	685 B 1 7/8	1
Inserti esagono maschio 7/8	688 E 12-17-19-22-24	5

~~€ 216,80~~ | **€ 149,00**



Gamma porta inserti 685 B e inserti macchina 688

ANTICORROSIONE E ANTIUSURA

Acciaio al cromo molibdeno e fosfatazione al manganese.

ISO 9227

SPINA DI TENUTA

Garantisce maggior tenuta dell'inserto nella sede rispetto al grano di bloccaggio.

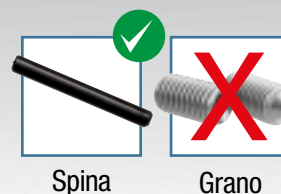

Spina

Grano

Modulare con i cassetti dei carrelli USAG



16 PEZZI

1 1/2"

235 1/2" M/C16

Cod. U02359285



Assortimento in cassetta modulare con bussole macchina esagonali

DESCRIZIONE	ART./MISURA	PZ.
Chiavi a bussola macchina con bocca esagonale	235 1/2 M 10-12-13-14-15-16-17-18-19-21-22-24-27-30-32 mm	15
Spina di tenuta	235 MCA/4-6	2
Anello di sicurezza	235 MDA/4-6	2
Prolunghe macchina	236 1/2 M/125	1

~~€ 219,20~~ | € 109,00



Modulare con i cassetti dei carrelli USAG



8 PEZZI

3 3/4"

235 3/4 M/C8

Cod. U02359286



Assortimento in cassetta modulare con bussole macchina esagonali

DESCRIZIONE	ART./MISURA	PZ.
Chiavi a bussola macchina con bocca esagonale	235 3/4" M 21-22-24-27-30-32-36-41 mm	8

~~€ 224,60~~ | € 119,00

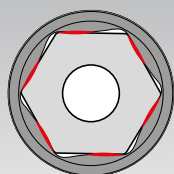
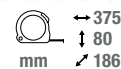

ISO 2725-2
ISO 1174-2

Gamma bussole esagonali macchina

PROFILO ESAGONALE

con geometria specifica per un perfetto contatto tra bussola e dado/vite.

ESECUZIONE FOSFATATA

ISO 9227

MARCATURA LASER

Logo e misura più visibile (misure 1" e 1 1/2" per incisione).

ACCIAIO SPECIALE

Cromo molibdeno per superiore resistenza agli impatti.

BUSSOLE MACCHINA 235 MB

DIMENSIONI COMPATTE, RESISTENZA GARANTITA.



ISO 1174-2
ISO 691



-25%

IDEALI PER
AVVITATORI
COMPATTI

25% DI LUNGHEZZA IN MENO
Stesse performance di una bussola standard 235 1/2 M.



235 1/2" MB/G10

Cod. U02350530



10
PEZZI

**Assortimento in cassetta modulare con
bussole macchina esagonali ribassate**



DESCRIZIONE	ART./MISURA	PZ.
Chiavi a bussola macchina ribassate con bocca esagonale	235 1/2" M 10-11-12-13-14-15-16-17-18-19	10

~~€ 85,83~~ | **€ 55,00**

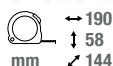

DETTAGLIO DELLE BUSSOLE CONTENUTE:

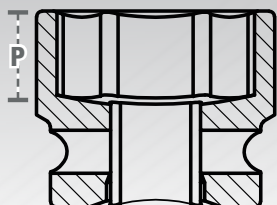

MISURA	Ø ESTERNO	LUNGHEZZA	P	MISURA	Ø ESTERNO	LUNGHEZZA	P
10	17 mm	28 mm	4 mm	15	23 mm	28 mm	5 mm
11	18 mm	28 mm	5 mm	16	24 mm	28 mm	5 mm
12	19 mm	28 mm	5 mm	17	26 mm	28 mm	8 mm
13	20 mm	28 mm	5 mm	18	28 mm	28 mm	8 mm
14	22 mm	28 mm	5 mm	19	28 mm	28 mm	8 mm

UTILIZZABILI CON CRICCHETTO O AVVITATORE

236 K per bussole



YouTube

MASSIMA ACCESSIBILITÀ
DIMENSIONI TESTA COME UN
CRICCHETTO*.



39 mm

*Confronto con cricchetto da 1/2".



YouTube

236 KE per inserti

MINIMO INGOMBRO
INNESTO DIRETTO PER
INSERTI MACCHINA.



Anello di tenuta
in acciaio integrato.

236 K

Prolunga a catena in alluminio per bussole

CODICE	□	L	H	📦
--------	---	---	---	---

U02360700	1/2"	340 mm	39 mm	1,1 kg	€ 110,00	€ 77,00
U02360698	1/4"	260 mm	27 mm	300 g	€ 83,00	€ 58,00



236 KE

Prolunga a catena in alluminio per inserti

CODICE	□	◇	L	H	📦
--------	---	---	---	---	---

U02360705	1/2"	1/2"	340 mm	24 mm	1,1 kg	€ 110,00	€ 77,00
U02360710	1/4"	1/4"	260 mm	19 mm	300 g	€ 83,00	€ 58,00



**CONTIENE LE NUOVE
BUSSOLE RIBASSATE
235 1/2" MB**



236 KE/C22

Cod. U02360900



**Assortimento in cassetta modulare con bussole
macchina esagonali ribassate, prolunga a
catena, inserti e accessori**

DESCRIZIONE	ART./MISURA	PZ.
Chiavi a bussola macchina ribassate con bocca esagonale	235 1/2" MB 13-14-15-16-17-18-19	7
Prolunga a catena	236 KE 1/2"	1
Inserti macchina esagonali	687 E 5-6-8-10-12-14	6
Inserti macchina TORX	687 TX T25-T27-T30-T40-T45-T50-T55	7
Adattatore per bussole	236 KEADP	1

~~€ 358,83~~ | **€ 199,00**

mm
↔ 415
↓ 92
↗ 283



**22
PEZZI**

IL CATALOGO COMPLETO A PORTATA DI MANO E SEMPRE AGGIORNATO!



Scarica l'App!

- Funziona offline.
- Notifiche push.
- Leggera.



SU SMARTPHONE E TABLET.

Sei un utilizzatore finale e vuoi contattarci?

Vai sul nostro sito:



usag.it/it/contacts/support



Oppure chiamaci: tel. 02.8295.3731 da Lunedì a Venerdì dalle 08:30 alle 19:30.

Offerta valida fino al 31 gennaio 2023 salvo esaurimento scorte, presso i Rivenditori che aderiscono all'iniziativa.

Tutti i prezzi sono da intendersi in Euro, IVA esclusa. Le immagini riprodotte in questa brochure sono indicative. Stanley Black & Decker Italia S.r.l. si riserva in ogni momento di modificare le caratteristiche tecniche dei prodotti.

IP U63000525Y

TIMBRO DEL RIVENDITORE

Stanley Black & Decker Italia S.r.l.
Via Volta, 3 - 21020 Monvalle (VA)
Tel. +39 0332 790111
Fax +39 0332 790330
info.mv@usag.it

usag.it

