

IDEAONE 2021

.02

fami

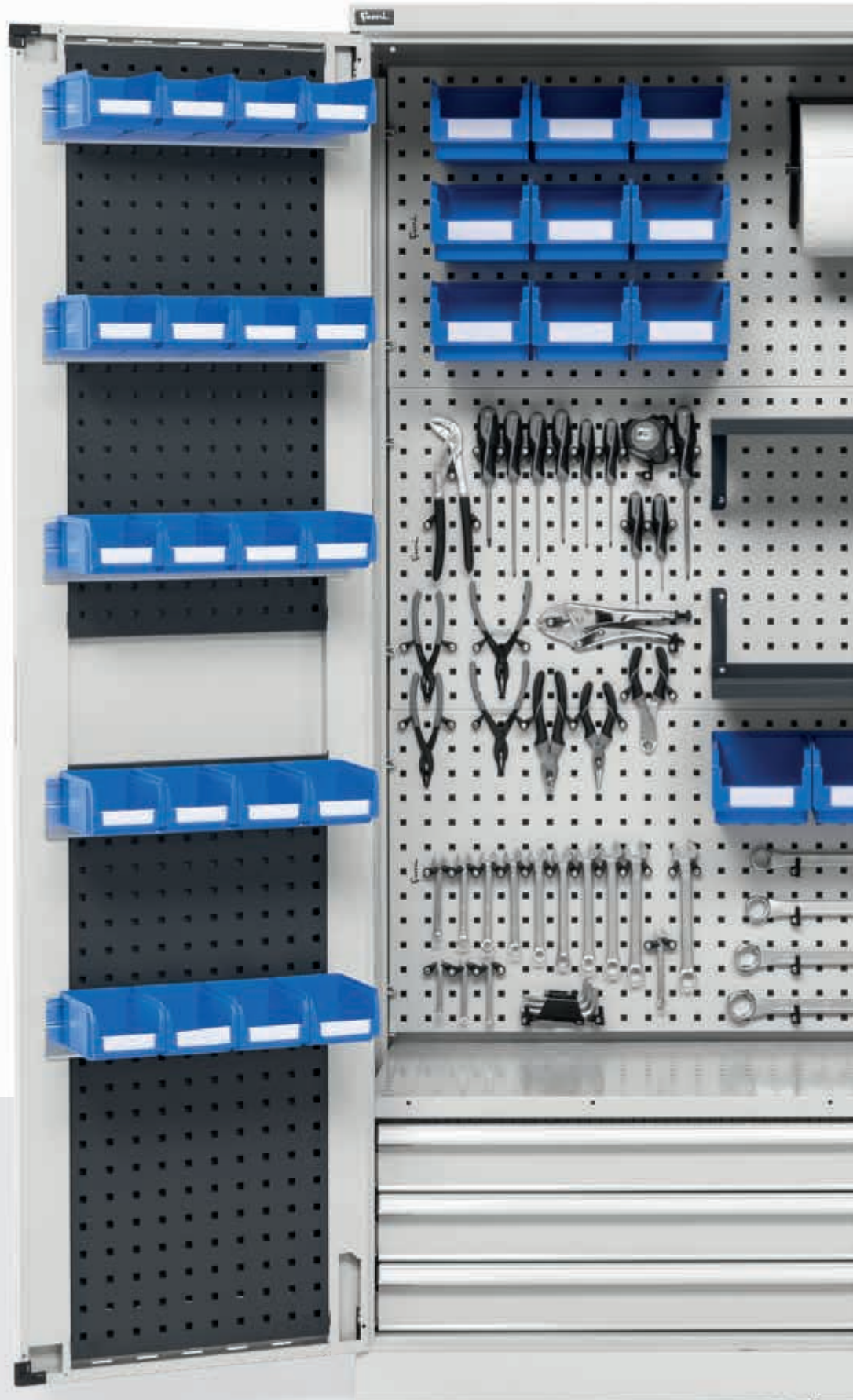

INNOVATION
SINCE 1929.



Prossimamente online il nuovo configuratore

Combina i diversi elementi e componenti online per realizzare il banco, il carrello, l'armadio perfetto per le tue necessità con il configuratore di Fami!

Innovativo, facile da utilizzare ed unico nel suo genere il planner ti consente di:

- Progettare il tuo arredo in 12 colori diversi
- Creare il tuo profilo personale in cui salvare i tuoi progetti
- Inserire i progetti creati nel carrello di Fami Shop
- Conoscere in qualsiasi momento i prezzi (aggiornati in tempo reale)

Visita il sito e inizia a ideare tutte le soluzioni che vuoi per allestire le diverse aree della tua azienda!

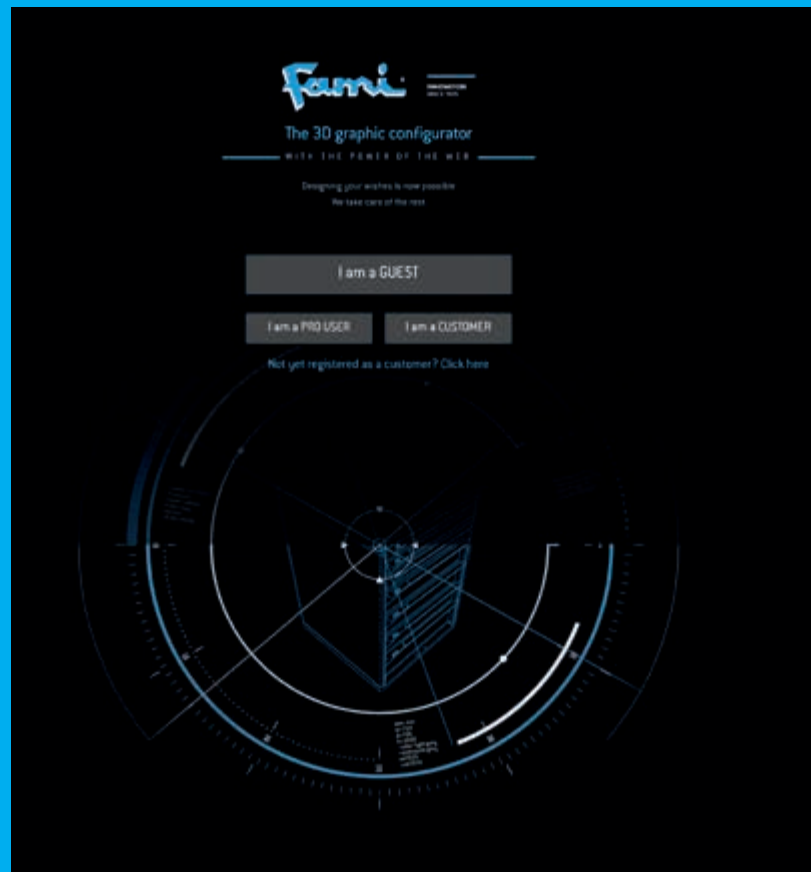

Progetta in pochi click l'arredo industriale perfetto per te!

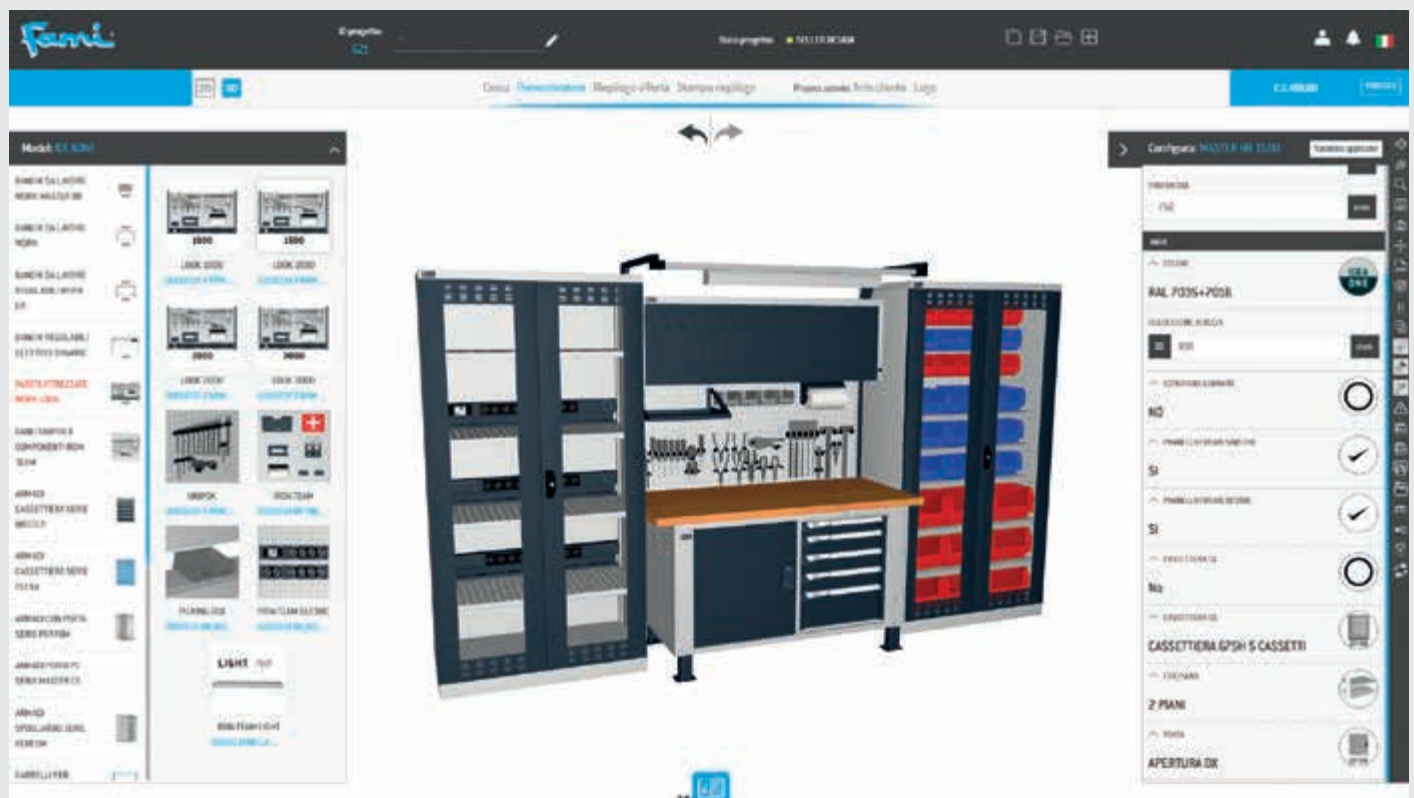



CONSULENZA

Un particolare progetto che vorresti realizzare, una nuova area da allestire? I consulenti commerciali di Fami sono al tuo fianco per analizzare tutte le tue necessità e realizzare gli arredi ideali per la tua azienda.



GARANZIA

I 10 anni di garanzia dei prodotti Fami sono la diretta espressione dell'utilizzo di materiali di qualità, della cura e dedizione nella produzione per rendere i nostri arredi affidabili e durevoli nel tempo.



ORDINI

Ordinare i prodotti Fami Ideaone non è mai stato così facile! Scegli i diversi arredi e contatta il tuo agente di zona o rivenditore per completare il tuo ordine. Oppure visita Fami Shop per acquistare in pochi click!



GAMMA COLORI

Arredi di colore diverso dal solito blu o grigio? I prodotti Fami Ideaone sono disponibili anche nella versione BICOLOR GRIGIO CHIARO e ANTRACITE per trasformare l'aspetto della tua azienda.



SPEDIZIONE

Gli arredi industriali Fami Ideaone sono disponibili con consegna entro 20 giorni lavorativi. La spedizione è gratuita per ordini superiori a 250,00 €, mentre per importi minori il costo di gestione ordine è pari a 30,00 €.



VALIDITÀ

Il catalogo Fami Ideaone ha validità trimestrale, dal 01/09/2021 al 31/12/2021. I prezzi si ritengono validi durante tale periodo, salvo possibili variazioni, errori tipografici e/o omissioni di stampa.

ASSISTENZA

Per qualsiasi domanda, informazione o problema il nostro servizio di assistenza post-vendita è sempre a tua disposizione. In caso di prodotti danneggiati o rotti riceverai sempre dei ricambi originali Fami in sostituzione.

FILIALI E RIVENDITORI

Fami è sempre accanto a te! Negli anni abbiamo sviluppato quattro filiali europee oltre a un'ampia rete di rivenditori e distributori, sia in Italia che all'estero, per fornirti consulenza e assistenza ovunque tu sia.



VASCHE DI RACCOLTA + RIPIANI E VASCHE PERFORM IN ACCIAIO
Idonee a liquidi infiammabili delle categorie GHS 1 – 3 e liquidi inquinanti per le acque delle categorie GHS 1 – 4.
Non sono ammesse sostanze corrosive.



VASCHE DI RACCOLTA IN PE
Idonee a liquidi inquinanti per le acque delle categorie GHS 1 – 4.
Non sono ammesse sostanze infiammabili.

indice

BANCHI DA LAVORO

6

- WORK MASTER BR 6



- WORK - WORK UP 22



- DYNAMIC 38



PARETI ATTREZZATE

46

- WORK LOOK 46



- UNIPOK 60



- IRON TEAM
IRON TEAM electric
IRON TEAM light 62



ARMADI

72

- MASTER STANDARD FLEXA 72



- MASTER CS STANDARD CS 82



ARMADI CON PORTE

86

- PERFOM porte a battente 86



- PERFOM porte scorrevoli 112



- PERFOM armadi spogliatoio 116



NC

- PORTAUTENSILI

120



120

SCAFFALI

- ST

142



- DOMINO

144



142

ECOLOGIA

- BENNE
PORTAFUSTI
ARMADI PORTE A BATTENTE

124



124

CASSETTE E CONTENITORI

- CASSETTE E
CONTENITORI IN METALLO

148



- CASSETTE E
CONTENITORI IN PLASTICA
TAPPETI ANTISDRUCCIOLO

154



148

CARRELLI

- CLEVER

130



- COMBI

139



- SMART

140



130

WORK MASTER BR

BANCHI DA LAVORO

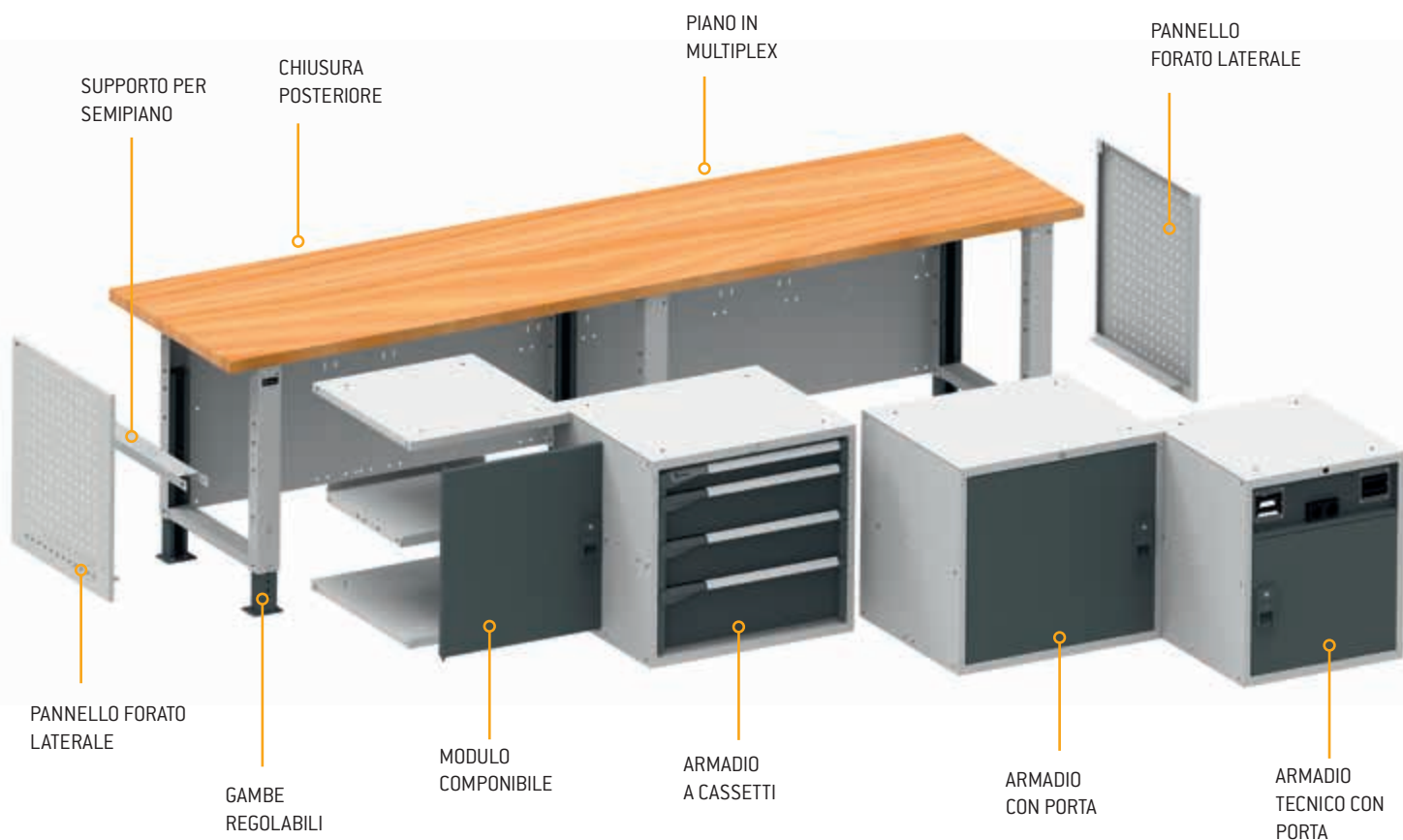

**CASSETTI AD
ESTRAZIONE TOTALE**

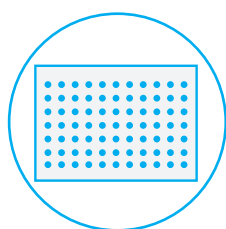

**CASSETTI
FORATI**

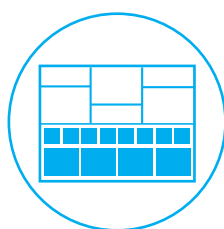

**MATERIALE DI
SEPARAZIONE**

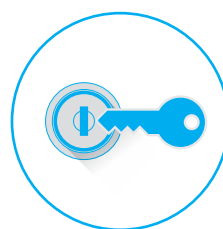

**CHIUSURA
A CHIAVE**

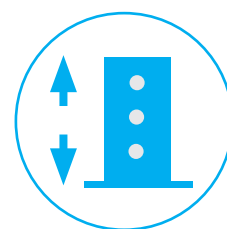

**GAMBE REGOLABILI
IN ALTEZZA**



BREVETTATO*

ART.	L mm	P mm	H mm	KG	RAL	€
MASTERBR2007	2000	750	1805/2180	1000	7035+7016	2.548,80

COMPOSTO DA:

- 1 banco smontato con piano in multiplex 40 mm
- 2 pannelli forati laterali
- 1 armadio con 4 cassetti L = 560 mm
- 4 piani superiori/inferiori per porta L=560 mm
- 1 porta totale sx
- 1 porta totale dx
- 2 piani interni
- 2 supporti semipiano intermedio aggiuntivo
- 1 cestino capacità 30 lt
- 2 porta bombole inclinate a 2 posti
- 1 tasca portadocumenti A4
- 1 kit 3 montanti biasolati
- 1 pannello forato ELECTRIC
- 1 pannello forato/mensola con 1 bordo fermacasse
- 1 kit 2 pannelli forati/mensole con 1 bordo fermacasse
- 1 multipresa Schuko a 4 scomparti
- 1 magnetotermico differenziale
- 2 multipresa Schuko a 2 scomparti
- 1 cavo di collegamento Wieland Schuko/FR
- 2 pensili vasistas senza serratura
- 2 kit staffe di fissaggio pensile vasistas su montanti
- 2 barre led
- 5 confezioni da 30 ganci Unipok
- 1 kit porta rotolo con carta Ø 240/300 mm

WORK MASTER BR 1500

 1000 kg

 REGOLABILI IN ALTEZZA

 PIANO IN MULTIPLEX SPESSORE 40 mm

 FORNITI SMONTATI

 PASSO FORI GAMBE 25 mm



CONFIGURE 

A



CONFIGURE 

B



CONFIGURE 

C

BREVETTATO*



CONFIGURE 

D



CONFIGURE 

E



CONFIGURE 

F

ART.	rif.	banco					armadio a cassetti							RAL	
		L mm	P mm	H mm	semipiani	pannelli laterali	H 75 mm	H 100 mm	H 150 mm	H 200 mm	H porta 600 mm	H porta 435 mm	L mm		
MASTERBR1505	A	1500	750	740/ 1115	-	-	1	2	-	-	-	-	560	7035+ 7016	733,50
MASTERBR1506	B	1500	750	740/ 1115	-	-	1	-	2	1	-	-	560	7035+ 7016	826,50
MASTERBR1501	C	1500	750	740/ 1115	2	2	1	-	2	1	-	-	560	7035+ 7016	956,70
MASTERBR1502	D	1500	750	740/ 1115	-	2	1	-	2	1	1	-	560	7035+ 7016	1.043,40
MASTERBR1503	E	1500	750	740/ 1115	-	-	2	3	2	2	-	-	560	7035+ 7016	1.395,00
MASTERBR1504	F	1500	750	740/ 1115	-	-	-	-	2	-	-	2	560	7035+ 7016	933,00

WORK MASTER BR 2000

 1000 kg

 REGOLABILI IN ALTEZZA

 PIANO IN MULTIPLEX SPESSORE 40 mm

 FORNITI SMONTATI

 PASSO FORI GAMBE 25 mm

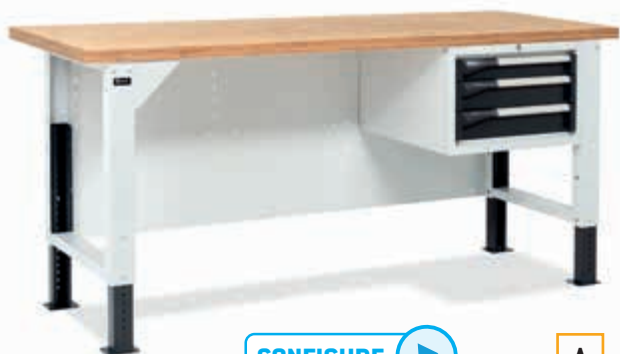

CONFIGURE 

A



CONFIGURE 

B



CONFIGURE 

C

BREVETTATO*



CONFIGURE 

D



CONFIGURE 

E



CONFIGURE 

F

ART.	rif.	banco					armadio a cassetti							RAL	€
		L mm	P mm	H mm	semipiani	pannelli laterali	H 75 mm	H 100 mm	H 150 mm	H 200 mm	H porta 600 mm	H porta 435 mm	L mm		
MASTERBR2005	A	2000	750	740/1115	-	-	1	2	-	-	-	-	560	7035+7016	778,50
MASTERBR2006	B	2000	750	740/1115	-	-	1	-	2	1	-	-	560	7035+7016	871,50
MASTERBR2001	C	2000	750	740/1115	2	-	1	-	2	1	1	-	560	7035+7016	1.149,00
MASTERBR2002	D	2000	750	740/1115	2	-	2	3	2	2	-	-	560	7035+7016	1.497,00
MASTERBR2003	E	2000	750	740/1115	-	2	1	3	-	1	2	-	560	7035+7016	1.318,80
MASTERBR2004	F	2000	750	740/1115	-	-	-	-	3	-	-	3	560	7035+7016	1.296,00

WORK MASTER BR COMPONENTI

 1000 kg

 REGOLABILI IN ALTEZZA

 PIANO IN MULTIPLEX SPESSORE 40 mm

 FORNITI SMONTATI

 PASSO FORI GAMBE 25 mm



CONFIGURE 

banco				piano		RAL	€
ART.	L mm	P mm	H mm	materiale	 mm		
MBR01SOV0V001PD	1024	750	740-1115	multiplex	40	7035+7016	255,00



CONFIGURE 

banco				piano		RAL	€
ART.	L mm	P mm	H mm	materiale	 mm		
MBR02SOV0V001PD	1500	750	740-1115	multiplex	40	7035+7016	297,00

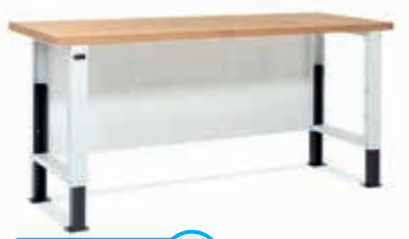

CONFIGURE 

banco				piano		RAL	€
ART.	L mm	P mm	H mm	materiale	 mm		
MBR03SOV0V001PD	2000	750	740-1115	multiplex	40	7035+7016	342,00



CONFIGURE 

banco				piano		RAL	€
ART.	L mm	P mm	H mm	materiale	 mm		
MBR04SOV0V001PD	3000	750	740-1115	multiplex	40	7035+7016	585,00

IMBALLO BANCO SMONTATO



x2

KIT 2 SQUADRE DI RINFORZO

ART.	L mm	P mm	H mm	RAL	€
FBGKITS0008	145	39	145	7035	19,50



IL KIT DI RINFORZO DEVE ESSERE ORDINATO SOLO SE NON SONO PRESENTI I PIANI O UNA CASSETTIERA SULL'ALTRO LATO DEL BANCO

BANCHI LUNGHEZZA 1000 mm

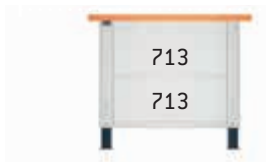

SCHEMA TECNICO

BANCHI LUNGHEZZA 1500 mm

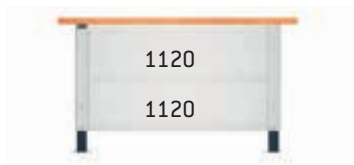

BANCHI LUNGHEZZA 2000 mm

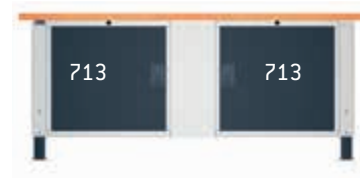
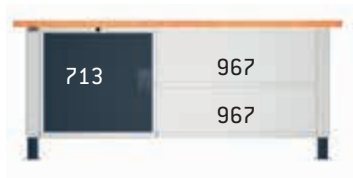
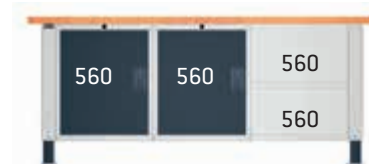
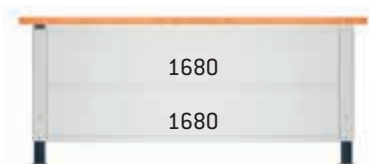

BANCHI LUNGHEZZA 3000 mm



WORK MASTER BR COMPONENTI

ARMADI L = 560 mm - 27x27 EH

ARMADIO CON 3 CASSETTI

armadio				cassetti					RAL	€
ART.	L mm	P mm	H mm	n.	H 75 mm	H 100 mm	KG			
MBR05SC010203PD	560	610	369	3	1	2	50-75-100	100-96-92%	7035+7016	417,00

ARMADIO CON 4 CASSETTI

armadio				cassetti					RAL	€	
ART.	L mm	P mm	H mm	n.	H 75 mm	H 150 mm	H 200 mm	KG			
MBR05SC010204PD	560	610	669	4	1	2	1	50-75-100	100-96-92%	7035+7016	510,00

ARMADIO CON 5 CASSETTI

armadio				cassetti					RAL	€	
ART.	L mm	P mm	H mm	n.	H 75 mm	H 100 mm	H 200 mm	KG			
MBR05SC010205PD	560	610	669	5	1	3	1	50-75-100	100-96-92%	7035+7016	588,00

ARMADIO CON PIANO INTERMEDIO PREDISPOSTO PER PORTE

armadio				piano regolabile	RAL	€
ART.	L mm	P mm	H mm			
MBR05SX00020708	560	610	669	1	7035	186,00

PORTA TOTALE SINISTRA

ART.	L mm	P mm	H mm	apertura porta	RAL	€
MBR06SC01020239	504	22	600	sx	7016	54,00

PORTA TOTALE DESTRA

ART.	L mm	P mm	H mm	apertura porta	RAL	€
MBR06SC01020139	504	22	600	dx	7016	54,00

560

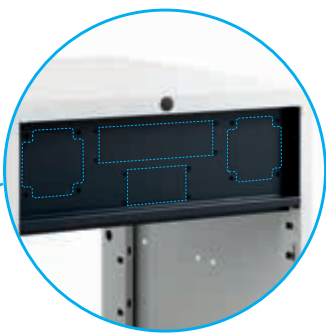

ARMADIO TECNICO PREDISPOSTO PER PORTE

ART.	L mm	P mm	H mm	KG	RAL	€
MBR05SX000208PD	560	610	669	25	7035	189,00

ART.
MBR06SC01020339ART.
MBR06SC01020439ARROTOLATORE ELETTRICO 230V CON
PRESA SCHUKO - 1600W - L=20 M

ART.	€
MBR13SOV0V00100	414,00

ARROTOLATORE PER ARIA COMPRESSA
TUBO Ø 10 mm - 15 BAR - L=14+1 M

ART.	€
MBR13SOV0V00200	198,00



RULLO PER ARROTOLATORE

ART.	€
MBR13SOV0V00339	25,50



PIASTRA

ART.	€
MBR13SOV0V00499	19,50

560



ARMADIO CON 1 CASSETTO PREDISPOSTO PER PORTE

armadio				cassetti				RAL	€
ART.	L mm	P mm	H mm	n.	H 150 mm	KG	ESTRAZIONE		
MBR05SC010206PD	560	610	669	1	1	50-75-100	100-96-92%	7035+ 7016	267,00

BREVETTATO*



PORTA PARZIALE SINISTRA

ART.	L mm	P mm	H mm	apertura porta	RAL	€
MBR06SC01020439	504	22	435	sx	7016	51,00



PORTA PARZIALE DESTRA

ART.	L mm	P mm	H mm	apertura porta	RAL	€
MBR06SC01020339	504	22	435	dx	7016	51,00



RAL 7016



RAL 7035



RAL 7035+RAL 7016



PORTATA KG



ESTRAZIONE

WORK MASTER BR COMPONENTI

ARMADI L = 713 mm - 36x27 EH

713



BREVETTATO*

ARMADIO CON 4 CASSETTI

armadio				cassetti						RAL	€
ART.	L mm	P mm	H mm	n.	H 75 mm	H 150 mm	H 200 mm	KG			
MBR05SC010304PD	713	610	669	4	1	2	1	50-75-100	100-96-92%	7035+ 7016	540,00

713



BREVETTATO*

ARMADIO CON 5 CASSETTI

armadio				cassetti						RAL	€
ART.	L mm	P mm	H mm	n.	H 75 mm	H 100 mm	H 200 mm	KG			
MBR05SC010305PD	713	610	669	5	1	3	1	50-75-100	100-96-92%	7035+ 7016	612,00

713



ARMADIO CON PIANO INTERMEDIO PREDISPOSTO PER PORTE

armadio				piano regolabile	RAL	€
ART.	L mm	P mm	H mm			
MBR05SX00030708	713	610	669	1	7035	198,00



PORTA TOTALE SINISTRA

ART.	L mm	P mm	H mm	apertura porta	RAL	€
MBR06SC01030239	657	22	600	sx	7016	57,00



PORTA TOTALE DESTRA

ART.	L mm	P mm	H mm	apertura porta	RAL	€
MBR06SC01030139	657	22	600	dx	7016	57,00



BREVETTATO*

CONFIGURE

ART.	L mm	P mm	H mm	KG	RAL	€
MASTERBR1508	1500	750	1985/2360	1000	7035+7016	2.024,40

COMPOSTO DA:

- 1 banco smontato con piano in multiplex 40 mm
- 2 pannelli forati laterali
- 1 armadio con 5 cassetti L = 560 mm
- 2 piani superiori/inferiori per porta L = 560
- 1 porta totale sx
- 1 piano interno
- 1 supporto semipiano intermedio aggiuntivo
- 1 kit 2 montanti biasolati per banchi
- 1 kit 3 pannelli forati/mensole con 2 bordi fermacasse
- 1 kit 2 supporti inclinati con binario base
- 1 lampada IRON TEAM doppia
- 4 confezioni da 30 ganci Unipok
- 2 pensili IRON TEAM con porta
- 1 kit porta rotolo con carta Ø 240/300 mm
- 1 supporto multipresa a 2 scomparti
- 1 multipresa Schuko a 2 scomparti
- 1 supporto multipresa a 4 scomparti
- 1 multipresa Schuko a 4 scomparti
- 1 cavo di collegamento Wieland Schuko/FR
- 1 cestino capacità 30 lt
- 2 porta bombole inclinate a 2 posti
- 1 tasca portadocumenti A4



BREVETTATO*

ARMADIO CON 1 CASSETTO PREDISPOSTO PER PORTE

ART.	armadio			n.	H 150 mm	cassetti		RAL	€
	L mm	P mm	H mm			KG	ESTRAZIONE		
MBR05SC010306PD	713	610	669	1	1	50-75-100	100-96-92%	7035+7016	282,00

PORTA PARZIALE SINISTRA

ART.	L mm	P mm	H mm	apertura porta	RAL	€
MBR06SC01030439	657	22	435	sx	7016	54,00

PORTA PARZIALE DESTRA

ART.	L mm	P mm	H mm	apertura porta	RAL	€
MBR06SC01030339	657	22	435	dx	7016	54,00



RAL 7016



RAL 7035



RAL 7035+RAL 7016



PORTATA KG



ESTRAZIONE

WORK MASTER BR COMPONENTI

MATERIALE DI SEPARAZIONE PER CASSETTIERA L=560 mm - 27x27 EH

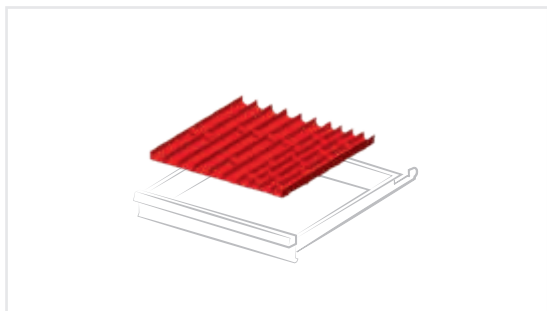

ART.	per altezza frontale mm	€
FFH84050200	50-300	18,60

Composto da 3 divisori 4 canali, 6 divisori 3 canali, 16 divisori trasversali 36 mm, 7 divisori trasversali 47 mm

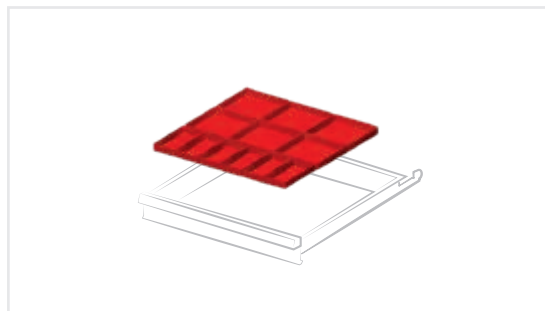

ART.	per altezza frontale mm	€
FFH84071800	75	17,70

FFH84101800	100	20,40
--------------------	-----	-------

Composto da 6 cassette divisorio 150x75 mm, 6 cassette divisorio 150x150 mm



ART.	per altezza frontale mm	€
FFH84050300	50-300	18,00

Composto da 3 divisori 3 canali, 6 divisori 2 canali, 15 divisori trasversali 47 mm, 8 divisori trasversali 73 mm

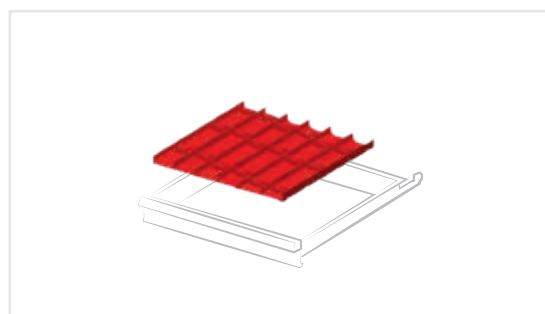

ART.	per altezza frontale mm	€
FFH84050400	50-300	17,40

Composto da 9 divisori 2 canali, 18 divisori trasversali 73 mm

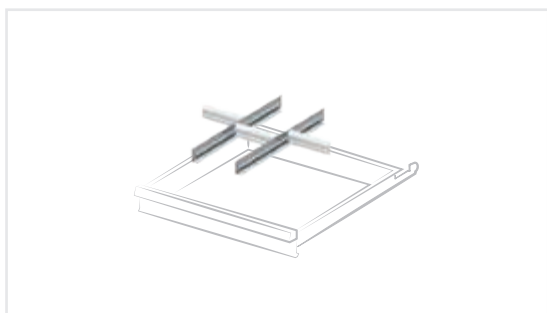

ART.	per altezza frontale mm	€
FFH84070800	75	11,40
FFH84100800	100	10,50
FFH84150800	150	13,20
FFH84200800	200	18,90

Composto da 2 divisori longitudinali fessurati 457 mm, 3 divisori trasversali 149 mm

WORK MASTER BR COMPONENTI

MATERIALE DI SEPARAZIONE PER CASSETTIERA L=713 mm - 36x27 EH

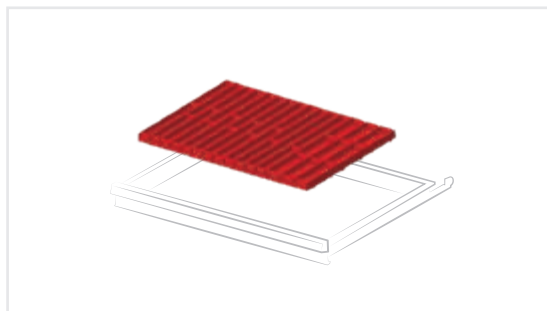

ART.	per altezza frontale mm	€
FFH10051000	50-300	27,00

Composto da 9 divisori 4 canali, 3 divisori 3 canali, 36 divisori trasversali 36 mm, 12 divisori trasversali 47 mm

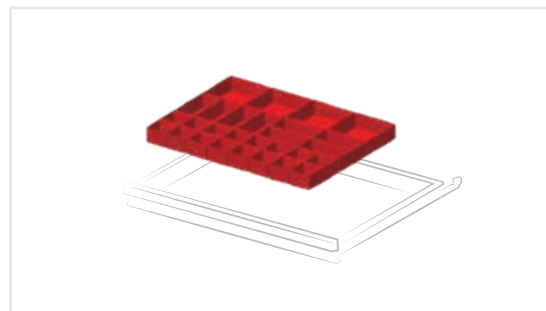

ART.	per altezza frontale mm	€
FFH10071800	75	24,90

Composto da 16 cassette divisorio 75x75 mm, 8 cassette divisorio 150x75 mm, 4 cassette divisorio 150x150 mm

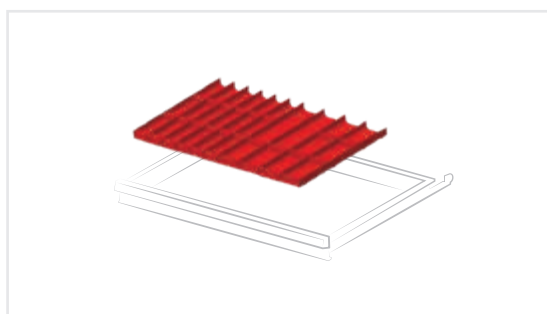

ART.	per altezza frontale mm	€
FFH10051300	50-300	22,50

Composto da 6 divisori 2 canali, 6 divisori 3 canali, 18 divisori trasversali 47 mm, 12 divisori trasversali 73 mm

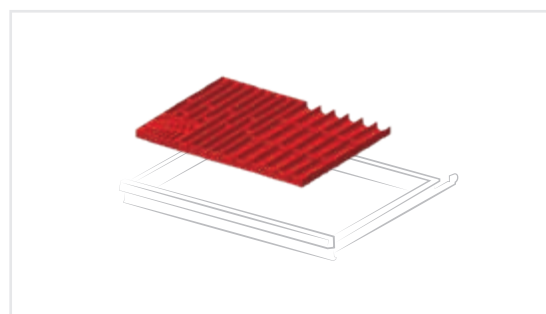

ART.	per altezza frontale mm	€
FFH10051500	50-300	25,80

Composto da 5 divisori 4 canali, 6 divisori 3 canali, 20 divisori trasversali 36 mm, 20 divisori trasversali 47 mm, 1 porta chiavi a brugola 150x150 mm

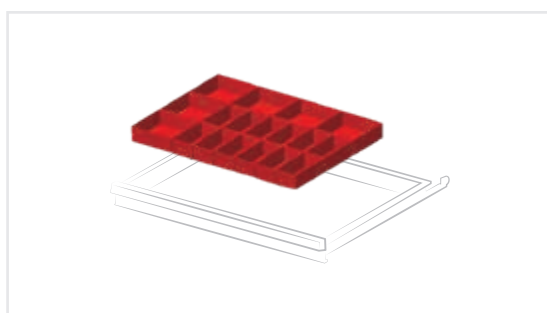

ART.	per altezza frontale mm	€
FFH10071600	75	22,50
FFH10101600	100	28,50

Composto da 12 cassette divisorio 150x75 mm, 6 cassette divisorio 150x150 mm

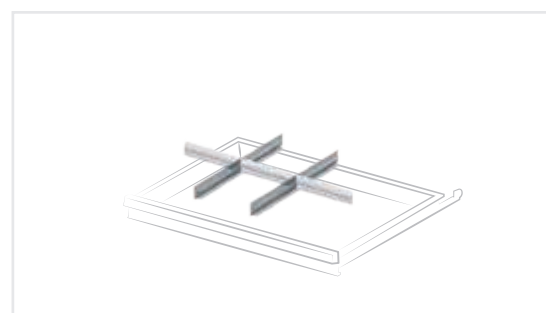

ART.	per altezza frontale mm	€
FFH10070500	75	12,00
FFH10100500	100	11,10
FFH10150500	150	14,40
FFH10200500	200	20,10

Composto da 2 divisori longitudinali fessurati 457 mm, 3 divisori trasversali 200 mm

WORK MASTER BR COMPONENTI

PANNELLO FORATO LATERALE

ART.	L mm	P mm	H mm	RAL	€
FBG15S00V0V0008 (IDEAONE06097)	610	18	669	7035	42,00



PIANO AGGIUNTIVO

ART.	L mm	P mm	H mm	KG	RAL	€
MBR08S070600008	713	605	35	250	7035	42,00
MBR08S090600008	967	605	35	250	7035	52,50
MBR08S110600008	1120	605	35	250	7035	52,50
MBR08S120600008	1273	605	35	250	7035	55,50
MBR08S160600008	1680	605	35	200	7035	70,50



SEMIPIANO AGGIUNTIVO

ART.	L mm	P mm	H mm	KG	RAL	€
MBR09S050300008	560	305	35	100	7035	28,50
MBR09S070300008	713	305	35	100	7035	28,50
MBR09S090300008	967	305	35	100	7035	31,50
MBR09S110300008	1120	305	35	100	7035	31,50
MBR09S120300008	1273	305	35	100	7035	36,00
MBR09S160300008	1680	305	35	100	7035	45,00



SUPPORTO PER SEMIPIANO INTERMEDIO

ART.	L mm	P mm	H mm	RAL	€
FBG13S605V00008 (IDEAONE06114)	605	77	34	7035	8,70





PIANO INTERNO 27x27 EH 1

ART.	L mm	P mm	H mm	KG	RAL	€
MBR11SOV0020008	558	466	60	100	7035	27,30



PIANO SUPERIORE E INFERIORE 27x27 EH 2

ART.	L mm	P mm	H mm	KG	RAL	€
MBR10S050600008	560	610	32	100	7035	31,20



SUPPORTO PER SEMIPIANO INTERMEDIO AGGIUNTIVO 3

ART.	L mm	P mm	H mm	RAL	€
FBG13S605V00008 (IDEAONE06114)	605	77	34	7035	8,70



PORTA TOTALE DESTRA 4

ART.	L mm	P mm	H mm	apertura porta	RAL	€
MBR06SC01020539	554	22	600	dx	7016	54,00



PORTA TOTALE SINISTRA 5

ART.	L mm	P mm	H mm	apertura porta	RAL	€
MBR06SC01020639	554	22	600	sx	7016	54,00

WORK MASTER BR



CONFIGURE 



ART.	L mm	P mm	H mm	KG	RAL	€
MASTERBR3001	3000	750	1985/2360	1000	7035+7016	4.243,80

COMPOSTO DA:

- 1 banco smontato con piano in multiplex 40 mm
- 2 pannelli forati laterali
- 1 armadio senza porta con piano intermedio L=560
- 1 porta totale sx
- 2 armadi con 4 cassetti L = 713 mm
- 1 armadio tecnico L=560 mm
- 1 porta parziale dx
- 1 piastra per arrotolatore
- 2 rulli per arrotolatore
- 1 arrotolatore elettrico 230V con presa Schuko
- 1 arrotolatore per aria compressa
- 1 multipresa Schuko a 2 scomparti
- 1 cavo di collegamento Wieland Schuko/FR
- 1 cestino capacità 30 lt
- 4 porta bombole inclinate a 2 posti
- 1 tasca portadocumenti A4
- 1 kit 3 montanti biasolati per banchi
- 2 kit 3 pannelli forati/mensole con 2 bordi fermacasse
- 1 kit 3 supporti inclinati con 2 binari base
- 2 lampade IRON TEAM doppie
- 3 kit 2 contenitori Picking Box misura 3A2
- 2 pensili IRON TEAM con porta
- 6 confezioni da 30 ganci Unipok
- 2 mensole grandi reversibili
- 1 barra aggancio contenitori con 4 contenitori Picking Box misura 1
- 1 kit porta rotolo con carta Ø 240/300 mm

BREVETTATO*

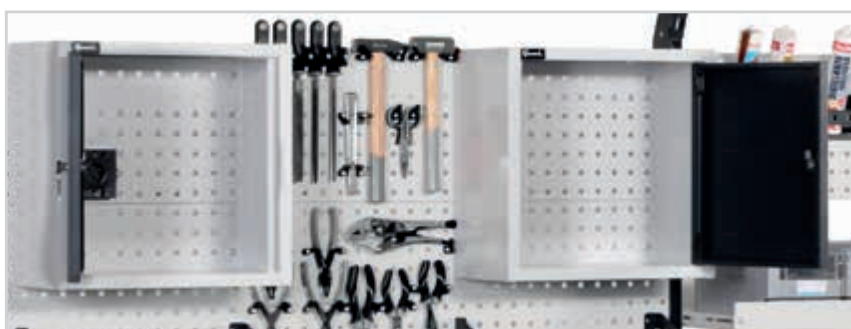

WORK - WORK UP

BANCHI DA LAVORO

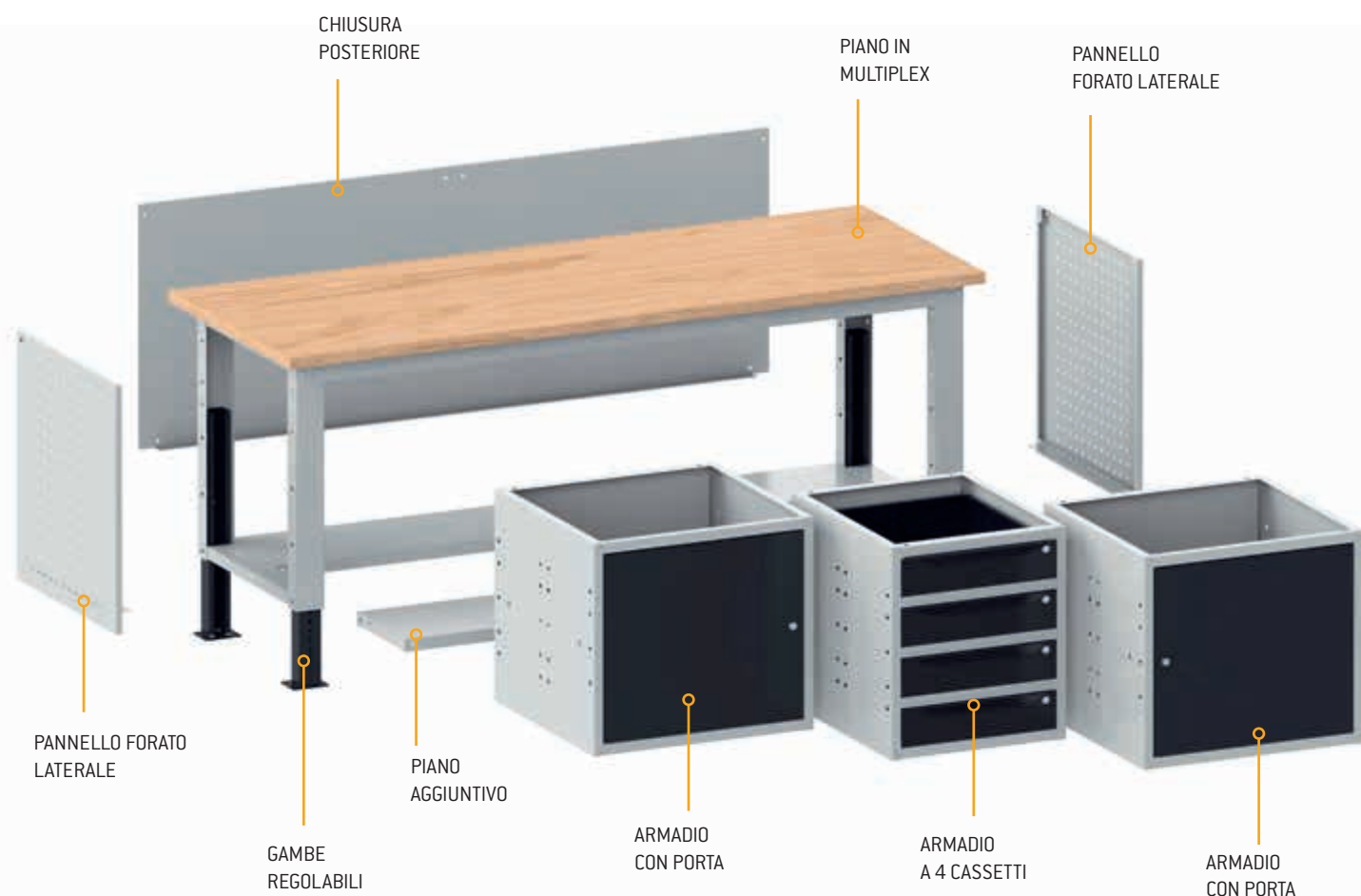

**CASSETTI AD
ESTRAZIONE SEMPLICE**

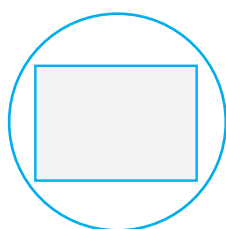

**CASSETTI
LISCI**

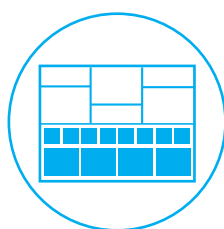

**MATERIALE DI
SEPARAZIONE**

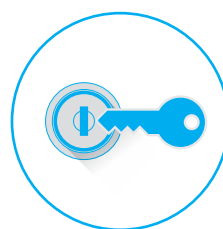

**CHIUSURA
A CHIAVE**

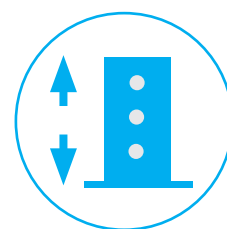

**GAMBE REGOLABILI
IN ALTEZZA**



BREVETTATO*

ART.	L mm	P mm	H mm	KG	RAL	€
WORK2013	2007	750	1977/2352	1000	7035+7016	2.542,50

COMPOSTO DA:

- 1 banco smontato con piano in multiplex 30 mm
- 2 armadi con porta totale e piano regolabile L = 629 mm
- 1 armadio con 4 cassetti L = 500 mm
- 2 pannelli forati laterali
- 1 semipiano non fessurato aggiuntivo
- 1 kit 3 montanti biasolati per banchi
- 2 kit 3 pannelli forati/mensole con 2 bordi fermacasse
- 1 kit 3 supporti inclinati con 2 binari base
- 2 binari base in alluminio con attacchi
- 1 set aria compressa con bilanciatore portata 1-2 kg e filtro
- 1 lampada IRON TEAM doppia
- 1 cestino capacità 30 lt
- 2 porta bombolette inclinati a 2 posti
- 2 tasche porta documenti A4
- 1 mensola grande reversibile
- 1 supporto per interruttore magnetotermico
- 1 supporto multipresa a 2 scomparti
- 1 supporto multipresa a 4 scomparti
- 1 magnetotermico differenziale
- 1 multipresa Schuko a 4 scomparti
- 1 multipresa Schuko a 2 scomparti
- 1 cavo di collegamento Wieland Schuko/FR
- 1 kit porta rotolo con carta Ø 240/300 mm
- 2 kit 2 contenitori PICKING BOX mis. 3A2
- 6 confezioni da 30 ganci Unipok

WORK UP 1500



1000 kg



REGOLABILI IN ALTEZZA



PIANO IN MULTIPLEX SPESSORE 30 mm



FORNITI SMONTATI



PASSO FORI GAMBE 25 mm



A [CONFIGURE](#)



B [CONFIGURE](#)



C [CONFIGURE](#)

ART.	rif.	banco				armadio a cassette						RAL	€
		L mm	P mm	H mm	semipiani	H 105 mm	H 150 mm	H porta 310 mm	H porta 490 mm	L 500 mm	L 629 mm		
WORK1501	A	1500	750	732/1107	1	-	1	-	-	1	-	7035+7016	385,50
WORK1502	A	1500	750	732/1107	1	-	1	-	-	1	-	5012	375,00
WORK1503	B	1500	750	732/1107	2	4	-	-	-	1	-	7035+7016	648,00
WORK1504	B	1500	750	732/1107	2	4	-	-	-	1	-	5012	624,00
WORK1507	C	1500	750	732/1107	2	4	-	-	-	1	-	7035+7016	701,70
WORK1508	C	1500	750	732/1107	2	4	-	-	-	1	-	5012	677,70

 1000 kg



REGOLABILI IN ALTEZZA



PIANO IN MULTIPLEX SPESSORE 30 mm



FORNITI SMONTATI



PASSO FORI GAMBE 25 mm



D

CONFIGURE



E

CONFIGURE



F

CONFIGURE



ART.	banco					armadio a cassetti						RAL	€
	rif.	L mm	P mm	H mm	semipiani	H 105 mm	H 150 mm	H porta 310 mm	H porta 490 mm	L 500 mm	L 629 mm		
WORK1505	D	1500	750	732/ 1107	1	4	-	-	1	2	-	7035+ 7016	783,00
WORK1506	D	1500	750	732/ 1107	1	4	-	-	1	2	-	5012	756,00
WORK1511	E	1500	750	732/ 1107	2	-	2	2	-	-	2	7035+ 7016	684,00
WORK1512	E	1500	750	732/ 1107	2	-	2	2	-	-	2	5012	666,00
WORK1509	F	1500	750	732/ 1107	2	4	-	-	1	-	2	7035+ 7016	819,00
WORK1510	F	1500	750	732/ 1107	2	4	-	-	1	-	2	5012	792,00

WORK UP 2000

 1000 kg



REGOLABILI IN ALTEZZA



PIANO IN MULTIPLEX SPESSORE 30 mm



FORNITI SMONTATI



PASSO FORI GAMBE 25 mm



A [CONFIGURE](#) 



B [CONFIGURE](#) 



C [CONFIGURE](#) 

ART.	banco					armadio a cassetti						RAL	€
	rif.	L mm	P mm	H mm	semipiani	H 105 mm	H 150 mm	H porta 310 mm	H porta 490 mm	L 500 mm	L 629 mm		
WORK2001	A	2000	750	732/1107	1	-	1	-	-	1	-	7035+7016	424,50
WORK2002	A	2000	750	732/1107	1	-	1	-	-	1	-	5012	417,00
WORK2003	B	2000	750	732/1107	2	4	-	-	-	1	-	7035+7016	696,00
WORK2004	B	2000	750	732/1107	2	4	-	-	-	1	-	5012	675,00
WORK2005	C	2000	750	732/1107	2	4	-	-	1	2	-	7035+7016	837,00
WORK2006	C	2000	750	732/1107	2	4	-	-	1	2	-	5012	813,00

 1000 kg



REGOLABILI IN ALTEZZA



PIANO IN MULTIPLEX SPESSORE 30 mm



FORNITI SMONTATI



PASSO FORI GAMBE 25 mm



D [CONFIGURE](#)



E [CONFIGURE](#)



F [CONFIGURE](#)

ART.	banco					armadio a cassette						RAL	€
	rif.	L mm	P mm	H mm	semipiani	H 105 mm	H 150 mm	H porta 310 mm	H porta 490 mm	L 500 mm	L 629 mm		
WORK2007	D	2000	750	732/ 1107	2	4	-	-	1	2	-	7035+ 7016	921,00
WORK2008	D	2000	750	732/ 1107	2	4	-	-	1	2	-	5012	897,00
WORK2011	E	2000	750	732/ 1107	2	-	3	3	-	1	2	7035+ 7016	900,00
WORK2012	E	2000	750	732/ 1107	2	-	3	3	-	1	2	5012	876,00
WORK2009	F	2000	750	732/ 1107	2	4	-	-	2	1	2	7035+ 7016	1.002,00
WORK2010	F	2000	750	732/ 1107	2	4	-	-	2	1	2	5012	975,00

WORK UP

1000 kg

REGOLABILI IN ALTEZZA

PIANO IN ACCIAIO SPESSORE 3 mm

FORNITI SMONTATI

PASSO FORI GAMBE 25 mm

PIANO IN MULTIPLEX SPESSORE 30 mm



CONFIGURE 1000

CONFIGURE 1500

CONFIGURE 2000

ART.	banco			piano		RAL	€
	L mm	P mm	H mm	materiale	mm		
FBG01S1000R00PD (IDEAONE06091)	1031	705	737/ 1111	acciaio	3	7035+7016	243,00
FBG01S1000R0004 (IDEAONE06061)	1031	705	737/ 1111	acciaio	3	5012	231,00
FBG01S1500R00PD (IDEAONE06093)	1507	705	737/ 1111	acciaio	3	7035+7016	294,00
FBG01S1500R0004 (IDEAONE06063)	1507	705	737/ 1111	acciaio	3	5012	276,00
FBG01S2000R00PD (IDEAONE06095)	2007	705	737/ 1111	acciaio	3	7035+7016	333,00
FBG01S2000R0004 (IDEAONE06065)	2007	705	737/ 1111	acciaio	3	5012	318,00



CONFIGURE 1000

CONFIGURE 1500

CONFIGURE 2000

ART.	banco			piano		RAL	€
	L mm	P mm	H mm	materiale	mm		
FBG02S1000R00PD (IDEAONE05128)	1024	750	732/ 1107	Multiplex	30	7035+7016	243,00
FBG02S1000R0004 (IDEAONE05096)	1024	750	732/ 1107	Multiplex	30	5012	231,00
FBG02S1500R00PD (IDEAONE05129)	1500	750	732/ 1107	Multiplex	30	7035+7016	282,00
FBG02S1500R0004 (IDEAONE05098)	1500	750	732/ 1107	Multiplex	30	5012	276,00
FBG02S2000R00PD (IDEAONE05130)	2000	750	732/ 1107	Multiplex	30	7035+7016	321,00
FBG02S2000R0004 (IDEAONE05100)	2000	750	732/ 1107	Multiplex	30	5012	318,00

IMBALLO BANCO SMONTATO



ruote in gomma antistraccia sintetica

KIT RUOTE ADATTE SOLO PER I BANCHI WORK UP

ART.	Ø	KG	H mm	materiale	ruota girevole	ruota girevole con freno	ruota fissa	€
FKRU1252101	125	300	155	gomma antistraccia sintetica	-	2	2	42,00
FKRS1252101	125	750	155	gomma elastica	-	2	2	69,00

ruota girevole ruota girevole con freno ruota fissa



SE IL BANCO CON RUOTE NON PRESENTA CASSETTIERE ALL'ESTREMITÀ È OBBLIGATORIO INSTALLARE IL KIT DI RINFORZO

KIT 2 SQUADRE DI RINFORZO

ART.	L mm	P mm	H mm	RAL	€
FBGKITS0008	145	39	145	7035	19,50
FBGKITS0004	145	39	145	5012	19,50



WORK

 1000 kg

PIANO IN ACCIAIO SPESSORE 3 mm

 FORNITI SMONTATI

PIANO IN MULTIPLEX SPESSORE 30 mm



[CONFIGURE 1000](#) [CONFIGURE 1500](#) [CONFIGURE 2000](#)

ART.	banco			piano		RAL	€
	L mm	P mm	H mm	materiale	mm		
FBG01S1000F00PD (IDEAONE06125)	1031	705	855	acciaio	3	7035+7016	204,00
FBG01S1000F0004 (IDEAONE06090)	1031	705	855	acciaio	3	5012	198,00
FBG01S1500F00PD (IDEAONE06126)	1507	705	855	acciaio	3	7035+7016	261,00
FBG01S1500F0004 (IDEAONE06089)	1507	705	855	acciaio	3	5012	249,00
FBG01S2000F00PD (IDEAONE06127)	2007	705	855	acciaio	3	7035+7016	306,00
FBG01S2000F0004 (IDEAONE06088)	2007	705	855	acciaio	3	5012	291,00



[CONFIGURE 1000](#) [CONFIGURE 1500](#) [CONFIGURE 2000](#)

ART.	banco			piano		RAL	€
	L mm	P mm	H mm	materiale	mm		
FBG02S1000F0008 (IDEAONE05124)	1024	750	880	Multiplex	30	7035	198,00
FBG02S1000F0004 (IDEAONE05127)	1024	750	880	Multiplex	30	5012	198,00
FBG02S1500F0008 (IDEAONE05123)	1500	750	880	Multiplex	30	7035	249,00
FBG02S1500F0004 (IDEAONE05126)	1500	750	880	Multiplex	30	5012	249,00
FBG02S2000F0008 (IDEAONE05122)	2000	750	880	Multiplex	30	7035	291,00
FBG02S2000F0004 (IDEAONE05125)	2000	750	880	Multiplex	30	5012	291,00

**IMBALLO BANCO
SMONTATO**



COPERTURA IN ACCIAIO GOMMATO PER PIANO IN ACCIAIO

ART.	L mm	P mm	H mm	€
FBG32100007 (IDEAONE06052)	1024	700	27	78,00
FBG32150007 (IDEAONE06053)	1500	700	27	108,00
FBG32200007 (IDEAONE06054)	2000	700	27	138,00

COPERTURA IN ACCIAIO GOMMATO PER PIANO IN MULTIPLEX

ART.	L mm	P mm	H mm	€
FBL22300007 (IDEAONE05109)	1024	750	20	63,00
FBL22600007 (IDEAONE05110)	1500	750	20	87,00
FBL22900007 (IDEAONE05111)	2000	750	20	108,00



WORK - WORK UP COMPONENTI

SCHEMA TECNICO

2000

1000



1500

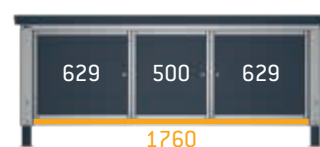
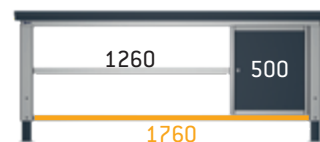
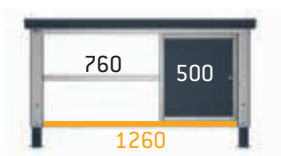

ARMADI A CASSETTI

L → 500 mm

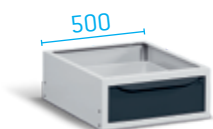

SENZA FONDO DI CHIUSURA



SENZA FONDO DI CHIUSURA



30

armadio				cassetti				porta		RAL	€
ART.	L mm	P mm	H mm	n.	KG		h utile mm	n.	H mm		
FBG03S50C0001PD (IDEAONE06099)	500	607	210	1	25	86%	137	-	-	7035+7016	103,50
FBG03S50C000104 (IDEAONE06035)	500	607	210	1	25	86%	137	-	-	5012	99,00

armadio				cassetti				porta		RAL	€
ART.	L mm	P mm	H mm	n.	KG		h utile mm	n.	H mm		
FBG03S50C0002PD (IDEAONE06122)	500	607	570	3	25	86%	137	-	-	7035+7016	243,00
FBG03S50C000204 (IDEAONE06033)	500	607	570	3	25	86%	137	-	-	5012	229,50

armadio				cassetti				porta		RAL	€
ART.	L mm	P mm	H mm	n.	KG		h utile mm	n.	H mm		
FBG03S50C0003PD (IDEAONE06103)	500	607	570	4	25	86%	92	-	-	7035+7016	330,00
FBG03S50C000304 (IDEAONE06102)	500	607	570	4	25	86%	92	-	-	5012	312,00

armadio				cassetti				porta		RAL	€
ART.	L mm	P mm	H mm	n.	KG		h utile mm	n.	H mm		
FBG03S50C0004PD (IDEAONE06106)	500	607	570	1	25	86%	137	1	310	7035+7016	168,00
FBG03S50C000404 (IDEAONE06034)	500	607	570	1	25	86%	137	1	310	5012	159,00

armadio				cassetti				porta		RAL	€
ART.	L mm	P mm	H mm	n.	KG		h utile mm	n.	H mm		
FBG03S50C0005PD (IDEAONE06109)	500	607	570	-	-	-	-	1	490	7035+7016	141,00
FBG03S50C000504 (IDEAONE06074)	500	607	570	-	-	-	-	1	490	5012	138,00



ART.	L mm	RAL	€
FBG16S50V0V0008 (IDEAONE06077)	500	7035	30,00
FBG16S50V0V0004 (IDEAONE06076)	500	5012	30,00

ART.	L mm	RAL	€
FBG16S63V0V0008 (IDEAONE06124)	629	7035	30,00
FBG16S63V0V0004 (IDEAONE06123)	629	5012	30,00

FONDO DI CHIUSURA PER ARMADI

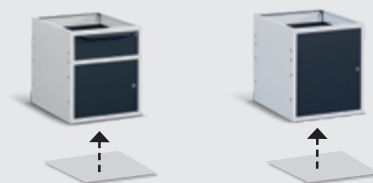

DA UTILIZZARE SOLO NEGLI ARMADI CON PORTA QUANDO È PRESENTE IL SEMIPIANO

ARMADI A CASSETTI

L → 629 mm



armadio				cassetti				porta		RAL	€
ART.	L mm	P mm	H mm	n.	KG	↓	h utile mm	n.	H mm		
FBG03S63C0002PD (IDEAONE06101)	629	607	570	3	25	86%	137	-	-	7035+7016	270,00
FBG03S63C000204 (IDEAONE06100)	629	607	570	3	25	86%	137	-	-	5012	255,00



armadio				cassetti				porta		RAL	€
ART.	L mm	P mm	H mm	n.	KG	↓	h utile mm	n.	H mm		
FBG03S63C0003PD (IDEAONE06105)	629	607	570	4	25	86%	92	-	-	7035+7016	348,00
FBG03S63C000304 (IDEAONE06104)	629	607	570	4	25	86%	92	-	-	5012	330,00



armadio				cassetti				porta		RAL	€
ART.	L mm	P mm	H mm	n.	KG	↓	h utile mm	n.	H mm		
FBG03S63C0004PD (IDEAONE06108)	629	607	570	1	25	86%	137	1	310	7035+7016	183,00
FBG03S63C000404 (IDEAONE06107)	629	607	570	1	25	86%	137	1	310	5012	177,00

SENZA FONDO DI CHIUSURA

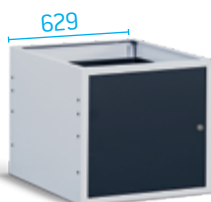

armadio				cassetti				porta		RAL	€
ART.	L mm	P mm	H mm	n.	KG	↓	h utile mm	n.	H mm		
FBG03S63C0005PD (IDEAONE06111)	629	607	570	-	-	-	-	1	490	7035+7016	153,00
FBG03S63C000504 (IDEAONE06110)	629	607	570	-	-	-	-	1	490	5012	150,00

SENZA FONDO DI CHIUSURA



WORK - WORK UP COMPONENTI

CHIUSURA POSTERIORE

ART.	L mm	P mm	H mm	RAL	€
FBG12S080000008 (IDEAONE06058)	825	48	665	7035	43,50
FBG12S080000004 (IDEAONE06048)	825	48	665	5012	43,50
FBG12S130000008 (IDEAONE06059)	1325	48	665	7035	52,50
FBG12S130000004 (IDEAONE06049)	1325	48	665	5012	52,50
FBG12S180000008 (IDEAONE06060)	1825	48	665	7035	70,50
FBG12S180000004 (IDEAONE06050)	1825	48	665	5012	70,50



COPPIA TAMPONI PER BANCO CON CASSETTIERA DA 629 mm

ART.	L mm	RAL	€
FBG14S130V00008 (IDEAONE06112)	65	7035	13,50
FBG14S130V00004 (IDEAONE06113)	65	5012	13,50



SOLO PER BANCO CON CASSETTIERA DA 629 mm

PANNELLO LATERALE CON FORO QUADRO 10x10 mm

ART.	L mm	P mm	H mm	RAL	€
FBG15S00V0V0008 (IDEAONE06097)	610	18	669	7035	42,00
FBG15S00V0V0004 (IDEAONE06098)	610	18	669	5012	42,00





PIANO NON FESSURATO AGGIUNTIVO

ART.	L mm	P mm	H mm	KG	RAL	€
FBG08S070600108 (IDEAONE06116)	760	600	35	250	7035	42,00
FBG08S070600104 (IDEAONE06117)	760	600	35	250	5012	42,00
FBG08S120600108 (IDEAONE06118)	1260	600	35	250	7035	55,50
FBG08S120600104 (IDEAONE06119)	1260	600	35	250	5012	55,50
FBG08S170600108 (IDEAONE06120)	1760	600	35	200	7035	70,50
FBG08S170600104 (IDEAONE06121)	1760	600	35	200	5012	70,50



SEMIPIANO NON FESSURATO AGGIUNTIVO

ART.	L mm	P mm	H mm	KG	RAL	€
FBG09S070300108 (IDEAONE06068)	760	300	35	100	7035	28,50
FBG09S070300104 (IDEAONE06067)	760	300	35	100	5012	28,50
FBG09S120300108 (IDEAONE06070)	1260	300	35	100	7035	36,00
FBG09S120300104 (IDEAONE06069)	1260	300	35	100	5012	36,00
FBG09S170300108 (IDEAONE06072)	1760	300	35	100	7035	45,00
FBG09S170300104 (IDEAONE06071)	1760	300	35	100	5012	45,00



SUPPORTO SOLO PER SEMIPIANO INTERMEDIO

ART.	L mm	P mm	H mm	RAL	€
FBG13S605V00008 (IDEAONE06114)	605	77	34	7035	8,70
FBG13S605V00004 (IDEAONE06115)	605	77	34	5012	8,70



WORK - WORK UP COMPONENTI

MATERIALE DI SEPARAZIONE PER CASSETTIERA L = 500



ART.	per altezza frontale mm	€
FBG18S50DV00199	105-150	11,70

Composto da 3 divisori trasversali

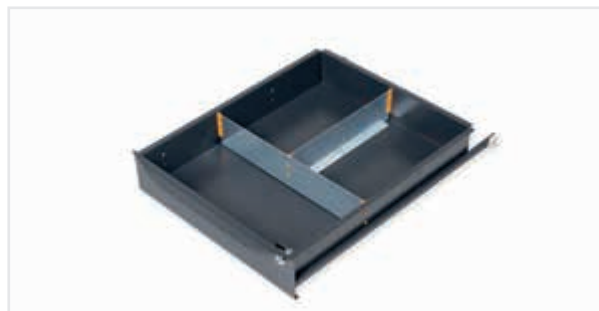

ART.	per altezza frontale mm	€
FBG18S50DV00299	105-150	8,40

Composto da 1 divisorio trasversale, 1 divisorio longitudinale



ART.	per altezza frontale mm	€
FBG18S50CD00103	105-150	6,90

Composto da 4 cassette divisorio 100x50 mm



ART.	per altezza frontale mm	€
FBG18S50CD00203	105-150	10,50

Composto da 2 cassette divisorio 150x75 mm, 3 cassette divisorio 100x50 mm, 1 cassetta divisorio 150x150 mm



TAPPETO PER CASSETTIERA L=500

ART.	per altezza frontale mm	€
FBG18S50TP00107	105-150	4,20



ART.	per altezza frontale mm	€
MATSEP001	105-150	25,80

Composto da 1 ART. FBG18S50DV00299, 1 ART. FBG18S50CD00103, 1 ART. FBG18S50CD00203



ART.	per altezza frontale mm	€
MATSEP002	105-150	36,30

Composto da 1 ART. FBG18S50DV00299, 1 ART. FBG18S50CD00103, 2 ART. FBG18S50CD00203

WORK - WORK UP COMPONENTI

MATERIALE DI SEPARAZIONE PER CASSETTIERA L = 629



ART.	per altezza frontale mm	€
FBG18S63DV00199	105-150	12,60

Composto da 3 divisori trasversali



ART.	per altezza frontale mm	€
FBG18S63DV00299	105-150	9,00

Composto da 1 divisorio trasversale, 1 divisorio longitudinale



ART.	per altezza frontale mm	€
FBG18S63CD00103	105-150	8,70

Composto da 5 cassette divisorio 100x50 mm



ART.	per altezza frontale mm	€
FBG18S63CD00203	105-150	10,50

Composto da 2 cassette divisorio 75x75 mm, 2 cassette divisorio 150x75 mm, 2 cassette divisorio 150x150 mm



TAPPETO PER CASSETTIERA L=629

ART.	per altezza frontale mm	€
FBG18S63TP00107	105-150	5,10



ART.	per altezza frontale mm	€
MATSEP003	105-150	28,20

Composto da 1 ART. FBG18S63DV00299, 1 ART. FBG18S63CD00103, 1 ART. FBG18S63CD00203



ART.	per altezza frontale mm	€
MATSEP004	105-150	38,70

Composto da 1 ART. FBG18S63DV00299, 1 ART. FBG18S63CD00103, 2 ART. FBG18S63CD00203

WORK - WORK UP

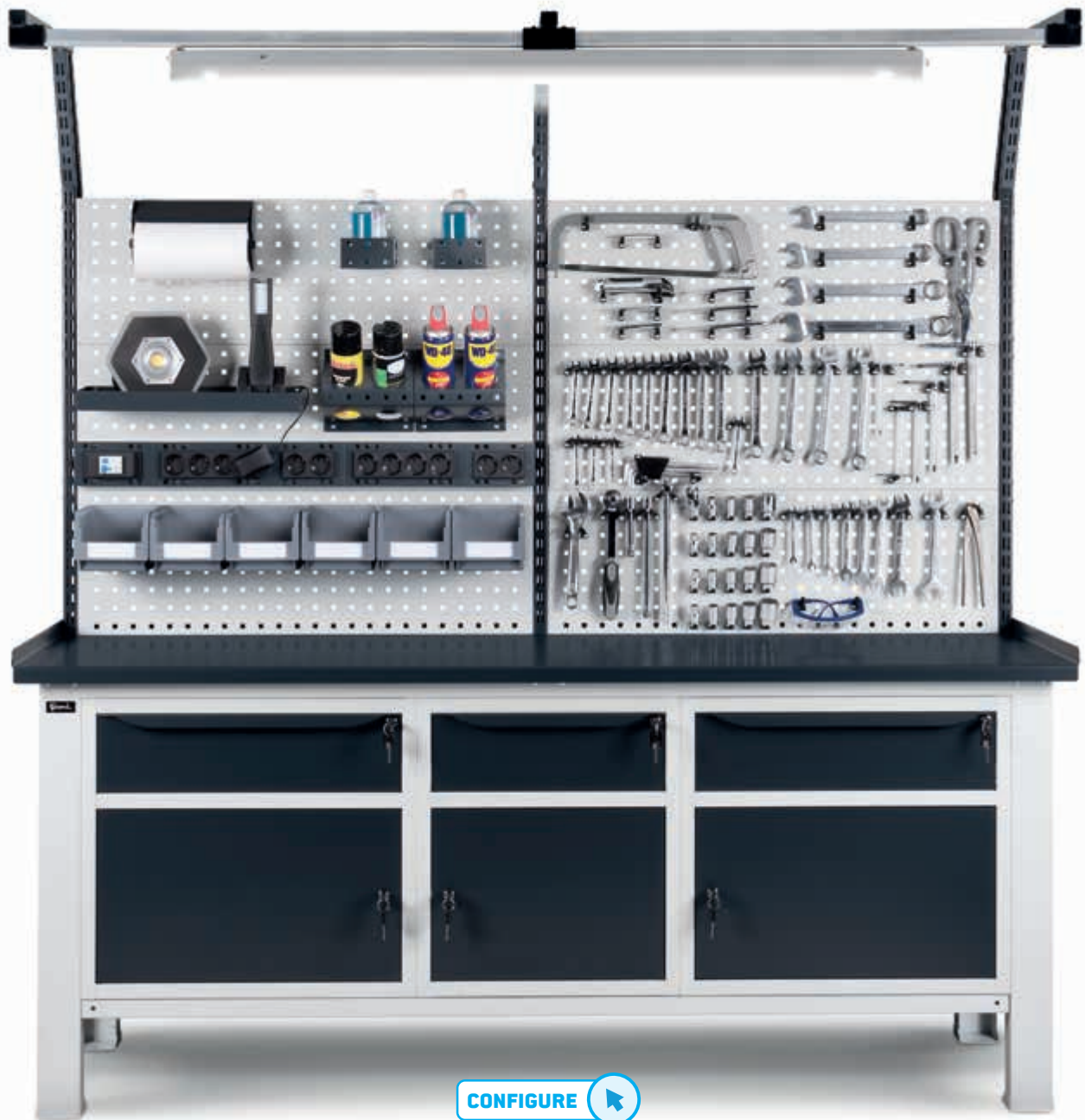

CONFIGURE 

ART.	L mm	P mm	H mm	 KG	RAL	€
WORK2015	2000	705	2098	1000	7035+7016	1.837,50

BREVETTATO*

COMPOSTO DA:

- 1 banco smontato con piano in acciaio 3 mm
- 2 armadi con 1 cassetto e porta parziale L = 629 mm
- 1 armadio con 1 cassetto e porta parziale L = 500 mm
- 1 kit 3 montanti biasolati per banchi
- 2 kit 3 pannelli forati/mensole con 2 bordi fermacasse
- 1 kit 3 supporti inclinati con 2 binari base
- 1 lampada IRON TEAM doppia
- 2 barre aggancio contenitori con 3 contenitori Picking Box mis. 2
- 1 supporto per interruttore magnetotermico
- 2 supporti multipresa a 2 scomparti
- 2 supporti multipresa a 4 scomparti
- 1 magnetotermico differenziale
- 2 multipresa Schuko a 4 scomparti
- 2 multipresa Schuko a 2 scomparti
- 1 cavo di collegamento Wieland Schuko/FR
- 1 mensola portaoggetti reversibile
- 2 porta bombole inclinate a 2 posti
- 1 kit porta rotolo con carta Ø 130 mm
- 2 porta flaconi igienizzanti reversibili
- 6 confezioni da 30 ganci Unipok

WORK - WORK UP



[CONFIGURE](#)

ART.	L mm	P mm	H mm	KG	RAL	€
WORK1513	1500	750	1977/2352	1000	7035+7016	2.052,00

BREVETTATO*

COMPOSTO DA:

- 1 banco smontato con piano in multiplex 30 mm
- 1 armadio con porta totale e piano regolabile L = 629 mm
- 1 fondo di chiusura per armadio
- 1 armadio con 4 cassette L = 629 mm
- 2 pannelli forati laterali
- 1 cestino capacità 30 lt
- 2 porta bombole inclinati a 2 posti
- 1 kit pronto soccorso
- 1 kit 2 montanti biasolati per banchi
- 1 kit 3 pannelli forati/mensole con 2 bordi fermacasse
- 1 kit 2 supporti inclinati con binario base
- 1 binario base in alluminio con attacchi
- 1 lampada IRON TEAM doppia
- 1 set aria compressa con bilanciatore portata 1-2 kg e filtro
- 2 barre aggancio contenitori con 3 contenitori Picking Box mis. 2
- 3 kit 2 contenitori Picking Box mis. 3A2
- 1 supporto multipresa a 2 scomparti
- 1 supporto multipresa a 4 scomparti
- 1 multipresa Schuko a 4 scomparti
- 1 multipresa Schuko a 2 scomparti
- 1 cavo di collegamento Wieland Schuko/FR
- 1 mensola grande reversibile
- 3 confezioni da 30 ganci Unipok

DYNAMIC

BANCHI DA LAVORO

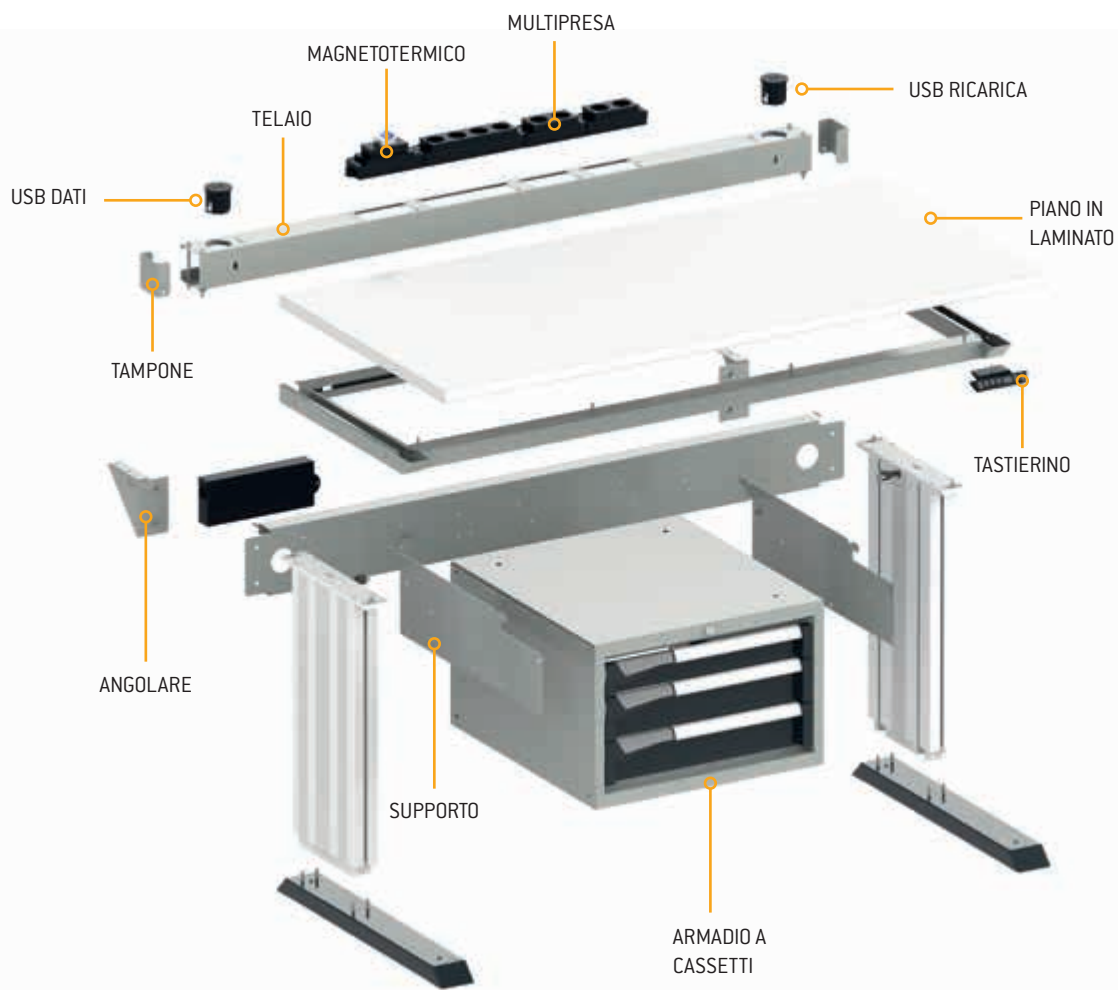

**PORTATA
BANCO 400 kg**

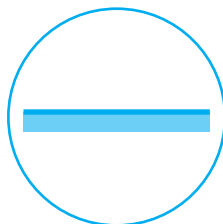

**PIANO IN
LAMINATO**

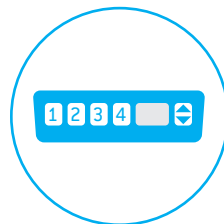

**TASTIERINO
CON 3 MEMORIE**

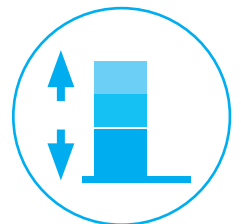

**REGOLABILE
IN ALTEZZA**



ART.	L mm	P mm	H mm	KG	RAL	€
DYNAMIC1504	1500	780	740/1140	400	7035+7016	2.223,00

COMPOSTO DA:

- 1 banco regolabile in altezza elettricamente
- 1 armadio con 3 cassetti L = 560 mm
- 1 coppia supporti per armadi
- 1 telaio porta prese aggiuntivo
- 1 presa USB dati
- 1 presa USB ricarica
- 1 magnetotermico differenziale
- 1 multipresa Schuko a 4 scomparti
- 2 multiprese Schuko a 2 scomparti
- 1 cavo di collegamento Wieland con spine in/out
- 1 cavo di collegamento Wieland Schuko/FR



DYNAMIC



CONFIGURE



ART.	L mm	P mm	H mm	KG	RAL	€
DYNAMIC1501	1500	780	1983/2383	400	7035+7016	2.862,00

BREVETTATO*

COMPOSTO DA:

- 1 banco regolabile in altezza elettricamente
- 1 telaio portaprese aggiuntivo
- 1 armadio con 3 cassetti L=560 mm
- 1 coppia supporti per armadio
- 1 kit 2 montanti biasolati per banchi
- 1 pannello forato ELECTRIC
- 2 pannelli forati/mensole con bordo fermacasse
- 1 kit 2 supporti inclinati con binario base
- 1 binario base in alluminio con attacchi
- 1 multipresa Schuko a 4 scomparti
- 1 magnetotermico differenziale
- 2 multiprese Schuko a 2 scomparti
- 1 cavo di collegamento Wieland Schuko/FR
- 1 presa USB dati
- 1 presa USB ricarica
- 2 lampade IRON TEAM singola
- 1 lampada IRON TEAM doppia

CONTENITORI IN POLIPROPILENE PICKING BOX MIS. 2 ESCLUSI.
CONTENITORI VEDI PAG. 159-160



ART.	L mm	P mm	H mm	KG	RAL	€
DYNAMIC1503	1500	780	1983/2383	400	7035+7016	2.754,00

COMPOSTO DA:

- 1 banco regolabile in altezza elettricamente
- 1 telaio portaprese aggiuntivo
- 1 armadio con 1 cassetto L=500 mm
- 1 coperchio per armadio
- 1 coppia supporti per armadi
- 1 kit 2 montanti biasolati per banchi
- 1 pannello forato Electric
- 1 pannello forato/mensola
- 2 pannelli forati/mensola con bordo fermacasse
- 1 kit 2 supporti inclinati con binario base
- 1 binario base in alluminio con attacchi
- 1 multipresa Schuko a 4 scomparti
- 1 magnetotermico differenziale
- 2 multipresa Schuko a 2 scomparti
- 1 cavo di collegamento Wieland Schuko/FR
- 1 presa USB dati
- 1 presa USB ricarica
- 1 mensola porta oggetti reversibile
- 3 lampade IRON TEAM singole
- 1 lampada IRON TEAM doppia
- 1 confezione da 30 ganci Unipok

BREVETTATO*

CONTENITORI IN POLIPROPILENE PICKING BOX MIS. 2 ESCLUSI.
CONTENITORI VEDI PAG. 159-160



ART.	L mm	P mm	H mm	KG	RAL	€
DYNAMIC1502	1500	780	1983/2383	400	7035+7016	2.544,00

COMPOSTO DA:

- 1 banco regolabile in altezza elettricamente
- 1 telaio portaprese aggiuntivo
- 1 kit 2 montanti biasolati per banchi
- 1 pannello forato Electric
- 2 pannelli forati/mensola con bordo fermacasse
- 1 kit 2 supporti inclinati con binario base
- 1 binario base in alluminio con attacchi
- 1 multipresa Schuko a 4 scomparti
- 1 magnetotermico differenziale
- 2 multipresa Schuko a 2 scomparti
- 1 cavo di collegamento Wieland Schuko/FR
- 1 presa USB dati
- 1 presa USB ricarica
- 2 pensili IRON TEAM con porta
- 1 mensola porta oggetti reversibile
- 1 lampada IRON TEAM singola
- 1 lampada IRON TEAM doppia

BREVETTATO*

CONTENITORI IN POLIPROPILENE PICKING BOX MIS. 2 ESCLUSI.
CONTENITORI VEDI PAG. 159-160

DYNAMIC COMPONENTI

 400 kg

 REGOLABILI IN ALTEZZA

 FORNITI SMONTATI

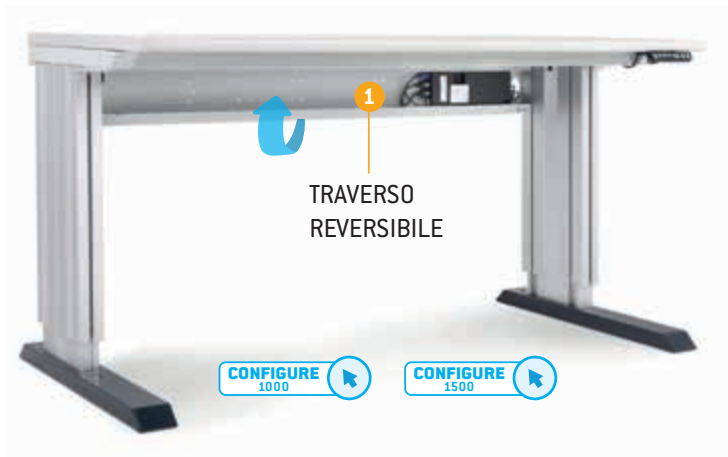

BANCO BASE

ART.	L mm	P mm	H mm	RAL	€
FLE0970E0PD	1006	700	740/1140	7035+7016	1.215,00
FLE1470E0PD	1491	700	740/1140	7035+7016	1.299,00

 BREVETTATO*



Il banco è dotato di gambe regolabili in altezza elettronicamente. L'altezza può variare da un minimo di 740 mm a un massimo di 1140 mm.



Il tastierino numerico consente di controllare il meccanismo di regolazione del banco. Oltre a consentire di modificare l'altezza del piano di lavoro, è dotato anche di 3 memorie di posizionamento per modificare rapidamente l'altezza del banco in base all'utilizzatore.

VISTA ANTERIORE DEL TRAVERSO



VISTA POSTERIORE DEL TRAVERSO



Il traverso del banco presenta delle incisioni per la collocazione delle prese elettriche e degli interruttori magnetotermici Iron Team Electric. In base alla dimensione scelta, il numero di intagli varia. I diversi componenti possono essere installati sia nella parte posteriore che anteriore del traverso.

GLI IRON TEAM ELECTRIC NON SONO COMPRESI CON IL TRAVERSO.

1000

SCHEMA
PRESE
traverso



1500



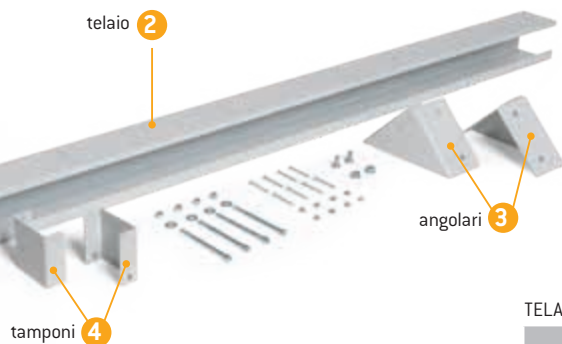

TELAIO PORTA PRESE AGGIUNTIVO

ART.	L mm	P mm	H mm	RAL	€
FBL46600008	1014	130	208	7035	60,00
FBL46650008	1499	130	208	7035	66,00

Composto da: 1 telaio, 2 tamponi, 2 angolari, set di viti



VISTA SUPERIORE DEL TELAI0



VISTA INFERIORE DEL TELAI0



Il telaio reversibile per banco presenta delle incisioni per la collocazione delle prese elettriche e degli interruttori magnetotermici Iron Team Electric. In base alla dimensione scelta, il numero di intagli varia. I diversi componenti possono essere installati sia nella parte superiore che inferiore del telaio reversibile. GLI IRON TEAM ELECTRIC NON SONO COMPRESI CON IL TELAI0 AGGIUNTIVO.

1000

SCHEMA
PRESE
telaio



USB dati magneto-termico multipresa 4 posti multipresa 2 posti multipresa 2 posti USB ricarica

1500

TELAIO
REVERSIBILE



USB dati magneto-termico multipresa 4 posti multipresa 2 posti multipresa 2 posti USB ricarica

DYNAMIC COMPONENTI

BREVETTATO*

560



armadio				cassetti					RAL	€
ART.	L mm	P mm	H mm	n.	H 75 mm	H 100 mm	KG			
MBR05SC010203PD	560	610	369	3	1	2	50-75-100	100-96-92%	7035+7016	417,00

500



armadio				cassetti					RAL	€
ART.	L mm	P mm	H mm	n.	H 150 mm	KG		H utile mm		
FBG03S50C0001PD (IDEAONE06099)	500	607	210	1	1	25	86%	137	7035+7016	103,50



COPERCHIO PER ARMADIO

ART.	L mm	P mm	H mm	RAL	€
FBL66900008	496	601	-	7035	27,00



SUPPORTI CON CASSETTO APPLICATO



COPPIA SUPPORTI PER ARMADIO A CASSETTI

ART.	L mm	P mm	H mm	RAL	€
FBL46010008	-	648	181	7035	21,00

IRON TEAM ELECTRIC

vedi pag. 68-70



FBLET012007
(IDEAONE05178)



FBLET004007
(IDEAONE05165)



FBLET005007
(IDEAONE05166)



FBLET016007
(IDEAONE05179)



FBLET013007
(IDEAONE05173)



FBLET020007



FBLET019007

WORK LOOK

PARETI ATTREZZATE

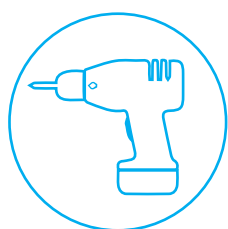
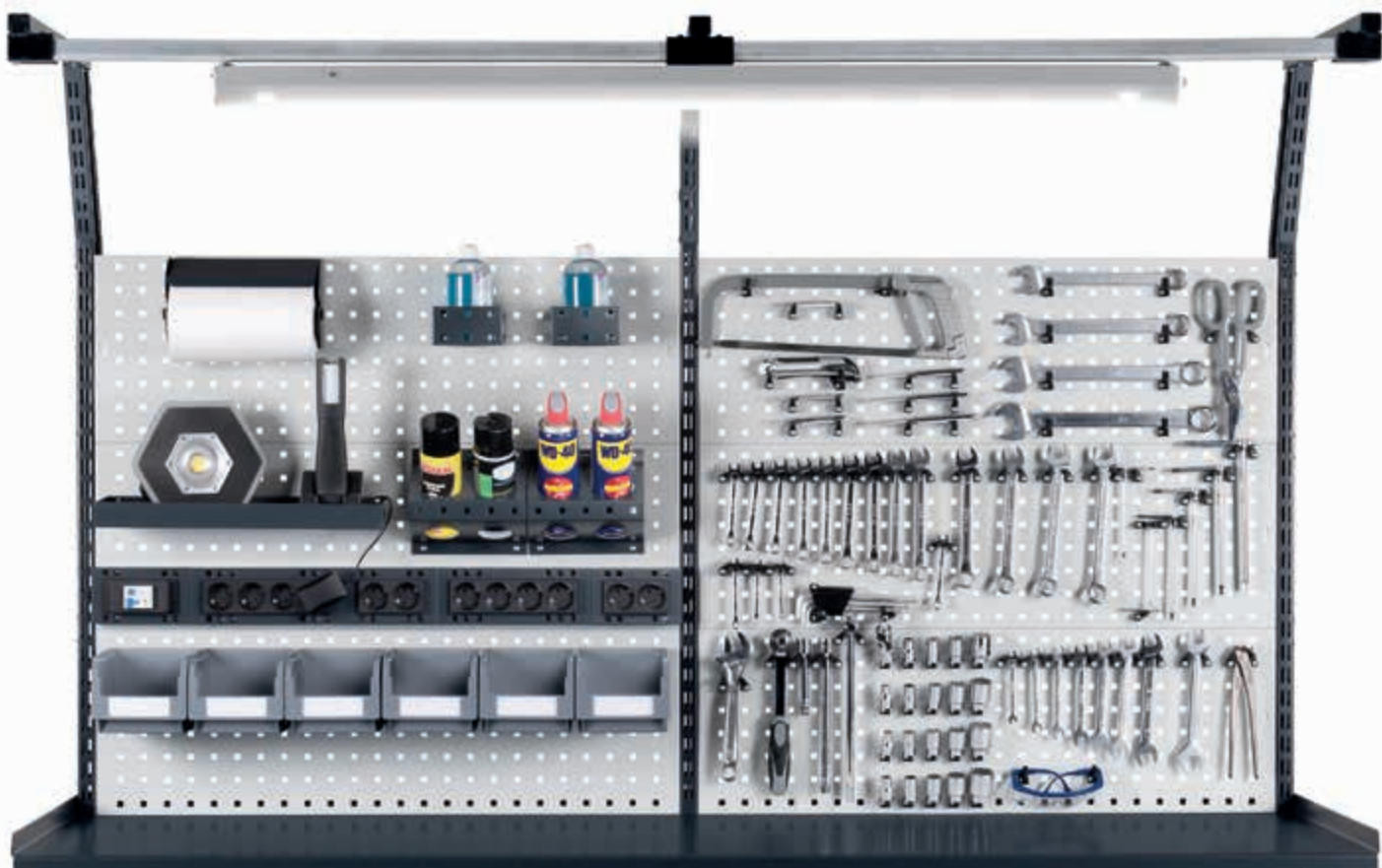

**FISSAGGIO
A MURO**

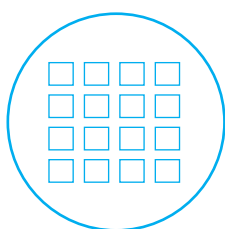

**FORI QUADRI
10x10**

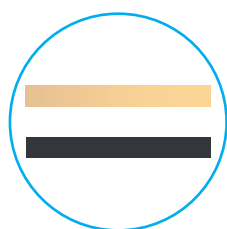

**ADATTE PER PIANI IN
LEGNO E ACCIAIO**

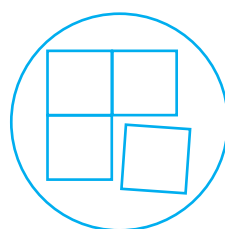

MODULARI

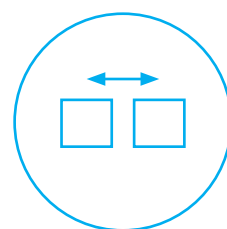

PASSO 38 mm



BREVETTATO*

ART.	L mm	P mm	H mm	KG	RAL	€
MASTERBR1507	1500	750	1985/2360	1000	7035+7016	2.167,20

COMPOSTO DA:

- 1 banco smontato con piano in Multiplex 40 mm
- 2 pannelli forati laterali
- 1 armadio con 5 cassetti L=560 mm
- 2 piani superiori/inferiori per porta
- 1 porta totale sx
- 1 supporto semipiano intermedio aggiuntivo
- 1 piano interno
- 1 cestino capacità 30 lt
- 2 porta bombolette inclinato a 2 posti
- 1 tasca portadocumenti A4
- 1 kit 2 montanti biasolati per banchi
- 1 kit 2 pannelli forati /mensole con bordo fermacasse
- 1 kit 2 supporti inclinati con binario base
- 1 lampada IRON TEAM doppia
- 1 pensile vasistas WORK LOOK senza serratura
- 1 kit staffe di fissaggio pensile vasistas WORK LOOK su montanti
- 1 barra led
- 1 mensola grande reversibile
- 1 barra aggancio contenitori con 4 contenitori Picking Box mis. 1
- 1 kit porta rotolo con carta Ø 130 mm
- 3 confezioni da 30 ganci Unipok
- 1 supporto multipresa a 2 scomparti
- 1 multipresa Schuko a 2 scomparti
- 1 supporto multipresa a 4 scomparti
- 1 multipresa Schuko a 4 scomparti
- 1 cavo di collegamento Wieland Schuko/FR
- 1 kit 2 contenitori Picking Box mis. 3A2

WORK LOOK



ART.	L mm	H mm	KG	RAL	€
WORKLOOK1001	1000	634	50	7035+7016	108,00
WORKLOOK1002	1000	634	50	5012	108,00

Pacchetto completo di 1 kit di 2 montanti biasolati per banchi, 1 kit di 2 pannelli forati/mensola con 1 bordo fermacasse



ART.	L mm	H mm	KG	RAL	€
WORKLOOK1003	1000	938	50	7035+7016	151,50
WORKLOOK1004	1000	938	50	5012	151,50

Pacchetto completo di 1 kit di 2 montanti biasolati per banchi, 1 kit di 3 pannelli forati/mensola con 2 bordi fermacasse



ART.	L mm	H mm	KG	RAL	€
WORKLOOK1501	1500	634	50	7035+7016	142,50
WORKLOOK1502	1500	634	50	5012	142,50

Pacchetto completo di 1 kit di 2 montanti biasolati per banchi, 1 kit di 2 pannelli forati/mensola con 1 bordo fermacasse



ART.	L mm	H mm	KG	RAL	€
WORKLOOK1503	1500	938	50	7035+7016	204,00
WORKLOOK1504	1500	938	50	5012	204,00

Pacchetto completo di 1 kit di 2 montanti biasolati per banchi, 1 kit di 3 pannelli forati/mensola con 2 bordi fermacasse





ART.	L mm	H mm	KG	RAL	€
WORKLOOK2001	2000	634	50	7035+7016	198,00
WORKLOOK2002	2000	634	50	5012	198,00

Pacchetto completo di 1 kit di 3 montanti biasolati per banchi, 2 kit di 2 pannelli forati/mensola con 1 bordo fermacasse

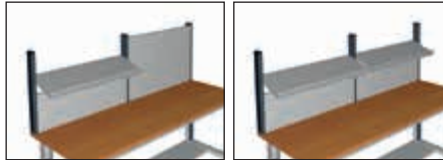

ART.	L mm	H mm	KG	RAL	€
WORKLOOK2003	2000	938	50	7035+7016	280,50
WORKLOOK2004	2000	938	50	5012	280,50

Pacchetto completo di 1 kit di 3 montanti biasolati per banchi, 2 kit di 3 pannelli forati/mensola con 2 bordi fermacasse



ART.	L mm	H mm	KG	RAL	€
WORKLOOK3001	3000	634	50	7035+7016	267,00
WORKLOOK3002	3000	634	50	5012	267,00

Pacchetto completo di 1 kit di 3 montanti biasolati per banchi, 2 kit di 2 pannelli forati/mensola con 1 bordo fermacasse

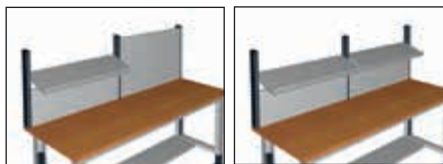

ART.	L mm	H mm	KG	RAL	€
WORKLOOK3003	3000	938	50	7035+7016	385,50
WORKLOOK3004	3000	938	50	5012	385,50

Pacchetto completo di 1 kit di 3 montanti biasolati per banchi, 2 kit di 3 pannelli forati/mensola con 2 bordi fermacasse



WORK LOOK



ART.	L mm	P mm	H mm	KG	RAL	€
WORKLOOK1005	1000	373	1066	50	7035+7016	429,00
WORKLOOK1006	1000	373	1066	50	5012	429,00

Pacchetto completo di 1 kit di 2 montanti biasolati per banchi, 1 kit di 2 pannelli forati/mensola con 1 bordo fermacasse, 1 pensile vasistas WORK LOOK senza serratura, 1 kit staffe di fissaggio pensile vasistas WORK LOOK su montanti



BREVETTATO*

ART.	L mm	P mm	H mm	KG	RAL	€
WORKLOOK1007	1000	373	1066	50	7035+7016	490,50
WORKLOOK1008	1000	373	1066	50	5012	490,50

Pacchetto completo di 1 kit di 2 montanti biasolati per banchi, 1 pannello forato/mensola con 1 bordo fermacasse, 1 pannello forato ELECTRIC, 1 pensile vasistas WORK LOOK senza serratura, 1 kit staffe di fissaggio pensile vasistas WORK LOOK su montanti, 1 multipresa Schuko a 4 scomparti, 1 cavo di collegamento Wieland Schuko/FR



ART.	L mm	P mm	H mm	KG	RAL	€
WORKLOOK1505	1500	373	1066	50	7035+7016	490,50
WORKLOOK1506	1500	373	1066	50	5012	490,50

Pacchetto completo di 1 kit di 2 montanti biasolati per banchi, 1 kit di 2 pannelli forati/mensola con 1 bordo fermacasse, 1 pensile vasistas WORK LOOK senza serratura, 1 kit staffe di fissaggio pensile vasistas WORK LOOK su montanti



BREVETTATO*

ART.	L mm	P mm	H mm	KG	RAL	€
WORKLOOK1507	1500	373	1066	50	7035+7016	549,00
WORKLOOK1508	1500	373	1066	50	5012	549,00

Pacchetto completo di 1 kit di 2 montanti biasolati per banchi, 1 pannello forato/mensola con 1 bordo fermacasse, 1 pannello forato ELECTRIC, 1 pensile vasistas WORK LOOK senza serratura, 1 kit staffe di fissaggio pensile vasistas WORK LOOK su montanti, 1 multipresa Schuko a 4 scomparti, 1 cavo di collegamento Wieland Schuko/FR



ART.	L mm	P mm	H mm	KG	RAL	€
WORKLOOK2005	2000	373	1066	50	7035+7016	835,50
WORKLOOK2006	2000	373	1066	50	5012	835,50

Pacchetto completo di 1 kit di 3 montanti biasolati per banchi, 2 kit di 2 pannelli forati/mensola con 1 bordo fermacasse, 2 pensili vasistas WORK LOOK senza serratura, 2 kit staffe di fissaggio pensile vasistas WORK LOOK su montanti

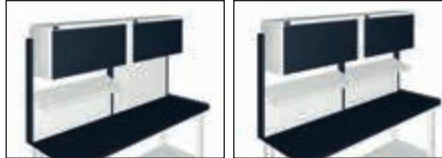

BREVETTATO*

ART.	L mm	P mm	H mm	KG	RAL	€
WORKLOOK2007	2000	373	1066	50	7035+7016	960,00
WORKLOOK2008	2000	373	1066	50	5012	960,00

Pacchetto completo di 1 kit di 3 montanti biasolati per banchi, 2 pannelli forati/mensola con 1 bordo fermacasse, 2 pannelli forati ELECTRIC, 2 pensili vasistas WORK LOOK senza serratura, 2 kit staffe di fissaggio pensile vasistas WORK LOOK su montanti, 2 multiprese Schuko a 4 scomparti, 1 cavo di collegamento Wieland Schuko/FR, 1 cavo di collegamento Wieland con spine in/out



ART.	L mm	P mm	H mm	KG	RAL	€
WORKLOOK3005	3000	373	1066	50	7035+7016	958,50
WORKLOOK3006	3000	373	1066	50	5012	958,50

Pacchetto completo di 1 kit di 3 montanti biasolati per banchi, 2 kit di 2 pannelli forati/mensola con 1 bordo fermacasse, 2 pensili vasistas WORK LOOK su montanti, 2 kit staffe di fissaggio pensile vasistas WORK LOOK su montanti



BREVETTATO*

ART.	L mm	P mm	H mm	KG	RAL	€
WORKLOOK3007	3000	373	1066	50	7035+7016	1.077,00
WORKLOOK3008	3000	373	1066	50	5012	1.077,00

Pacchetto completo di 1 kit di 3 montanti biasolati per banchi, 2 pannelli forati/mensola con 1 bordo fermacasse, 2 pannelli forati ELECTRIC, 2 pensile vasistas WORK LOOK senza serratura, 2 kit staffe di fissaggio pensile vasistas WORK LOOK su montanti, 2 multiprese Schuko a 4 scomparti, 1 cavo di collegamento Wieland Schuko/FR, 1 cavo di collegamento Wieland con spine in/out

WORK LOOK

MONTANTI



KIT 2 MONTANTI PER BANCHI 1000-1500 (3 UNITÀ)

ART.	H mm	RAL	€
FBL75351639 (IDEAONE05132)	938	7016	45,00
FBL75351604 (IDEAONE05134)	938	5012	45,00

KIT 3 MONTANTI PER BANCHI 2000-3000 (3 UNITÀ)

ART.	H mm	RAL	€
FBL75352139 (IDEAONE05136)	938	7016	67,50
FBL75352104 (IDEAONE05138)	938	5012	67,50

KIT 2 MONTANTI PER BANCHI 1000-1500 (2 UNITÀ)

ART.	H mm	RAL	€
FBL75301639 (IDEAONE05131)	634	7016	37,50
FBL75301604 (IDEAONE05133)	634	5012	37,50

KIT 3 MONTANTI PER BANCHI 2000-3000 (2 UNITÀ)

ART.	H mm	RAL	€
FBL75302139 (IDEAONE05135)	634	7016	57,00
FBL75302104 (IDEAONE05137)	634	5012	57,00

WORK LOOK

SUPPORTI INCLINATI CON BINARIO BASE

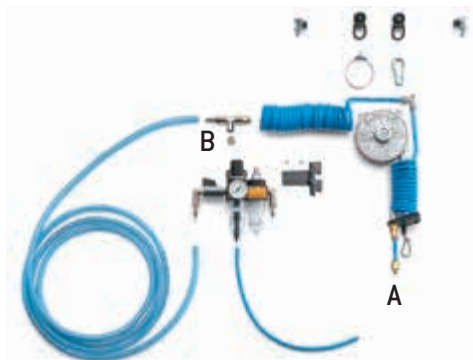

KIT 2 SUPPORTI INCLINATI CON BINARIO

ART.	L mm	P mm	H mm	RAL	€
FBL98102039 (IDEAONE05147)	1000	685	307	7016	84,00
FBL98102004 (IDEAONE05152)	1000	685	307	5012	72,00

KIT 2 SUPPORTI INCLINATI CON BINARIO

ART.	L mm	P mm	H mm	RAL	€
FBL98152039 (IDEAONE05148)	1500	685	307	7016	87,00
FBL98152004 (IDEAONE05153)	1500	685	307	5012	73,50

KIT 3 SUPPORTI INCLINATI CON 2 BINARI

ART.	L mm	P mm	H mm	RAL	€
FBL98202039 (IDEAONE05149)	2000	685	307	7016	132,00
FBL98202004 (IDEAONE05154)	2000	685	307	5012	111,00

KIT 3 SUPPORTI INCLINATI CON 2 BINARI

ART.	L mm	P mm	H mm	RAL	€
FBL98302039 (IDEAONE05150)	3000	685	307	7016	138,00
FBL98302004 (IDEAONE05155)	3000	685	307	5012	120,00

BINARIO BASE/AGGIUNTIVO CON ATTACCHI

ART.	L mm	colore	€
FBL98101000 (IDEAONE05185)	1000	alluminio	22,50
FBL98151000 (IDEAONE05186)	1500	alluminio	25,50

SET ARIA COMPRESSA CON BILANCIATORE PORTATA 1-2 KG E FILTRO

ART.	€
FBL97200300 (IDEAONE05187)	379,50

Completo di: 1 cavo flessibile Ø 10 mm - 1 connettore a T da 1/4" con tappo (B), 2 fermi - 2 attacchi di scorrimento - 1 moschettone, 1 bilanciatore con cavo in acciaio lunghezza 1600 mm, 1 attacco universale 1/4" per utensili (A), 1 tubo a spirale diametro interno 5,5 mm, 1 tubo diametro interno 5,5 mm per lo spurgo del filtro, 1 gruppo filtro regolatore con manometro - il quale può essere utilizzato con una pressione massima di 10 bar, la sua capacità è di circa 9 litri al secondo (sul punto A) e di 11 litri al secondo (sul punto B) con una pressione di utilizzo pari a 6,3 bar (la capacità può variare a seconda delle caratteristiche tecniche della rete pneumatica a cui l'impianto Fami viene allacciato) - Raccordi da 1/4"

WORK LOOK

PANNELLI FORATI/MENSOLA 953 mm

x 1



x 2



x 1

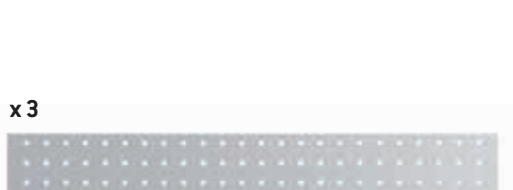

x 3



x 2



x 1



x 1

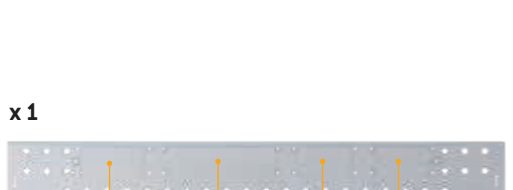

x 1



BREVETTATO*

PANNELLO FORATO FERITOIE 10x10 INTERASSE 38 mm (1 UNITÀ)

ART.	L mm	P mm	H mm	RAL	€
FBL76160008 (IDEAONE05193)	953	30	304	7035	31,50
FBL76160004 (IDEAONE05199)	953	30	304	5012	31,50

KIT 2 PANNELLI FORATI/MENSOLA CON 1 BORDO FERMACASSE (1 UNITÀ)

ART.	L mm	P mm	H mm	RAL	€
FBL76160208 (IDEAONE05139)	953	30	304	7035	70,50
FBL76160204 (IDEAONE05143)	953	30	304	5012	70,50

KIT 3 PANNELLI FORATI/MENSOLA CON 2 BORDI FERMACASSE (1 UNITÀ)

ART.	L mm	P mm	H mm	RAL	€
FBL76160308 (IDEAONE05141)	953	30	304	7035	106,50
FBL76160304 (IDEAONE05145)	953	30	304	5012	106,50

KIT 1 PANNELLO FORATO/MENSOLA CON 1 BORDO FERMACASSE (1,5 UNITÀ)

ART.	L mm	P mm	H mm	RAL	€
FBL76170108 (IDEAONE05191)	953	30	456	7035	55,50
FBL76170104 (IDEAONE05197)	953	30	456	5012	55,50

PANNELLO PREDISPOSTO PER PRESE ELETTRICHE (0,5 UNITÀ)

ART.	L mm	P mm	H mm	RAL	€
FBL76180008 (IDEAONE05189)	953	30	152	7035	33,00
FBL76180004 (IDEAONE05195)	953	30	152	5012	33,00

WORK LOOK

PANNELLI FORATI/MENSOLA 1438 mm

x 1



PANNELLO FORATO FERITIOIE 10x10 INTERASSE 38 mm (1 UNITÀ)

ART.	L mm	P mm	H mm	RAL	€
FBL76310008 (IDEAONE05194)	1438	30	304	7035	48,00
FBL76310004 (IDEAONE05200)	1438	30	304	5012	48,00

x 2



KIT 2 PANNELLI FORATI/MENSOLA CON 1 BORDO FERMACASSE (1 UNITÀ)

ART.	L mm	P mm	H mm	RAL	€
FBL76310208 (IDEAONE05140)	1438	30	304	7035	105,00
FBL76310204 (IDEAONE05144)	1438	30	304	5012	105,00

BORDO FERMACASSE

x 1

x 3



KIT 3 PANNELLI FORATI/MENSOLA CON 2 BORDI FERMACASSE (1 UNITÀ)

ART.	L mm	P mm	H mm	RAL	€
FBL76310308 (IDEAONE05142)	1438	30	304	7035	159,00
FBL76310304 (IDEAONE05146)	1438	30	304	5012	159,00

BORDO FERMACASSE

x 2

x 1



KIT 1 PANNELLO FORATO/MENSOLA CON 1 BORDO FERMACASSE (1,5 UNITÀ)

ART.	L mm	P mm	H mm	RAL	€
FBL76320108 (IDEAONE05192)	1438	30	456	7035	73,50
FBL76320104 (IDEAONE05198)	1438	30	456	5012	73,50

BORDO FERMACASSE

x 1

x 1



PANNELLO PREDISPOSTO PER PRESE ELETTRICHE (0,5 UNITÀ)

ART.	L mm	P mm	H mm	RAL	€
FBL76330008 (IDEAONE05190)	1438	30	152	7035	46,50
FBL76330004 (IDEAONE05196)	1438	30	152	5012	46,50

USB DATI

MAGNETOTERMICO
DIFFERENZIALE

MULTIPRESA
4 POSTI

MULTIPRESA
2 POSTI

MULTIPRESA
2 POSTI

USB RICARICA

BREVETTATO*

WORK LOOK

KIT FISSAGGIO A MURO



ART.	RAL	€
WORKLOOK9001	7035	973,50

BREVETTATO*

COMPOSTE DA:

- 3 pannelli forati/mensola H 304 mm
- 2 pannelli forati/mensola H 456 mm con bordo fermacasse
- 5 kit staffe per fissaggio pannelli a muro
- 1 cestino capacità 30 lt
- 2 mensole grandi reversibili
- 1 dispenser per guanti
- 1 porta flacone igienizzante reversibile
- 1 porta rotolo con carta Ø 240/300 mm
- 1 tasca porta documenti A4
- 1 mensola porta oggetti reversibile
- 1 supporto per interruttore magnetotermico
- 1 supporto multipresa a 2 scomparti
- 1 supporto multipresa a 4 scomparti
- 1 magnetotermico differenziale
- 1 multipresa Schuko a 2 scomparti
- 1 multipresa Schuko a 4 scomparti
- 1 cavo di collegamento Wieland Schuko/FR
- 5 confezioni da 30 ganci Unipok
- 2 lampade IRON TEAM doppie

KIT STAFFE

KIT STAFFE PER FISSAGGIO PANNELLI A MURO

ART.	colore	€
FBL76000099 (IDEAONE05286)	zincato	6,00

Viterie di fissaggio escluse



PANNELLI VEDI PAG. 54-55

WORK LOOK

PENSILI



PENSILE VASISTAS

ART.	L mm	P mm	H mm	KG	RAL	€
FBL8005X000PD	943	350	456	80	7035+7016	291,00
FBL8005X00004	943	350	456	80	5012	291,00
FBL8010X000PD	1428	350	456	80	7035+7016	318,00
FBL8010X00004	1428	350	456	80	5012	318,00



SET DI CHIUSURA

ART.	€
FBL8020C00000	9,60



COPPIA STAFFE FISSAGGIO PENSILE AI MONTANTI BIASOLATI

ART.	L mm	P mm	H mm	RAL	€
FBL8025000008	210	325	455	7035	22,50
FBL8025000004	210	325	455	5012	22,50



LED SOTTOPENSILE

ART.	L mm	€
FBL99400213	873	28,50
FBL99450213	1173	30,00

! È OBBLIGATORIO L'USO DELLA COPPIA STAFFE PER IL FISSAGGIO DEL PENSILE AI MONTANTI BIASOLATI

VALIDA DAL 01/09/2021 AL 31/12/2021 - PREZZI NETTI - IVA ESCLUSA

RAL 5012

RAL 7035

RAL 7035+RAL 7016



PORTATA KG

WORK LOOK

FISSAGGIO A PARETE

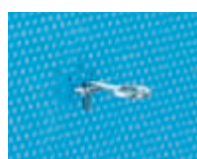

ESCLUSO MATERIALE DI FISSAGGIO



GANCIO PORTACHIAVI CON OCCHIELLO AGGANCIAMENTO Ø 22 mm

ART.	multiplo d'ordine	Ø mm	colore	€ cadauno
FBG39700099 (IDEAONE05034)	25	17	zincato	0,60



SOSTEGNO SEMPLICE AGGANCIAMENTO INTERASSE Ø 22 mm

ART.	multiplo d'ordine	L mm	colore	€ cadauno
FBG39720099 (IDEAONE05036)	25	110	zincato	0,60

PANNELLO PORTA ATTREZZI FORO TONDO Ø 4 mm

ART.	L mm	H mm	RAL	€
FBG39100008 (IDEAONE05079)	1000	850	7035	75,00
FBG39100004 (IDEAONE05039)	1000	850	5012	75,00
FBG39150008 (IDEAONE05070)	1500	850	7035	93,00
FBG39150004 (IDEAONE05030)	1500	850	5012	93,00
FBG39200008 (IDEAONE05071)	2000	850	7035	120,00
FBG39200004 (IDEAONE05031)	2000	850	5012	120,00

MENSOLA PER PANNELLI PORTA ATTREZZI

ART.	L mm	P mm	H mm	RAL	€
FBG39400008 (IDEAONE05078)	1000	140	146	7035	22,50
FBG39400004 (IDEAONE05038)	1000	140	146	5012	22,50
FBG39450008 (IDEAONE05073)	1500	140	146	7035	25,50
FBG39450004 (IDEAONE05033)	1500	140	146	5012	25,50
FBG39500008 (IDEAONE05072)	2000	140	146	7035	30,00
FBG39500004 (IDEAONE05032)	2000	140	146	5012	30,00



SOSTEGNO SEMPLICE AGGANCIAMENTO INTERASSE Ø 22 mm

ART.	multiplo d'ordine	L mm	colore	€ cadauno
FBG39710099 (IDEAONE05035)	25	60	zincato	0,60



SOSTEGNO SEMPLICE AGGANCIAMENTO INTERASSE Ø 22 mm

ART.	multiplo d'ordine	L mm	colore	€ cadauno
FBG39730099 (IDEAONE05037)	25	150	zincato	0,60

WORK LOOK

FAMICARES



FAMICARES
COLONNINA PER
DISINFETTANTE MANI

WWW.FAMISPA.COM

TOTEM IGIENIZZANTE IN ACCIAIO SENZA ACCESSORI

ART.	L mm	P mm	H mm	RAL	€
FBL76320208 (IDEAONE05159)	650	397	1559	7035	144,00

IRON TEAM

vedi pag. 62



FBLIT002039
(IDEAONE05161)



FBLIT005039
(IDEAONE05164)



FBLIT003039
(IDEAONE05162)

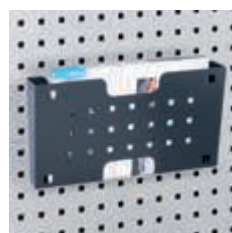

FBLIT001039
(IDEAONE05158)



FBLIT015039
(IDEAONE05160)

SEDIE DA LAVORO



ART.	H mm	€
FQZ22110007 (IDEAONE23002)	495/670	171,00

Sedile e schienale in poliuretano, ruote autobloccanti, regolabile con pompa a gas



ART.	H mm	€
FQZ12110007 (IDEAONE23001)	470/645	126,00

Sedia in faggio, ruote autobloccanti, regolabile in altezza con pompa a gas



ART.	H mm	€
FQZ22200007 (IDEAONE23003)	535/785	204,00

Sedile e schienale in poliuretano, piedini fonoassorbenti e poggiatesta regolabile cromato, regolabile con pompa a gas

GANCI



**FISSAGGIO SU
LEGNO**



**FISSAGGIO SU
PANNELLO FORATO**

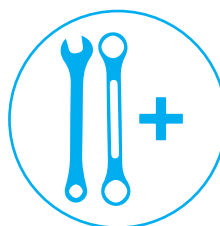

**ADATTO PER TUTTI
GLI UTENSILI**

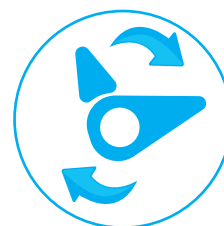

**MOLTEPLICI
POSIZIONI**

BREVETTATO*

x30

x30

x30

x15



ART.	pz. per confezione	colore	€
FBLIT009007 (IDEAONE05219)	30	nero	10,50

FORO QUADRO 10x10 mm - PASSO 38 mm



CON 1 CONFEZIONE SI POSSONO
AGGANCIARE FINO A 30 UTENSILI

FISSAGGIO SU
LEGNO



FISSAGGIO SU
PANNELLO FORATO

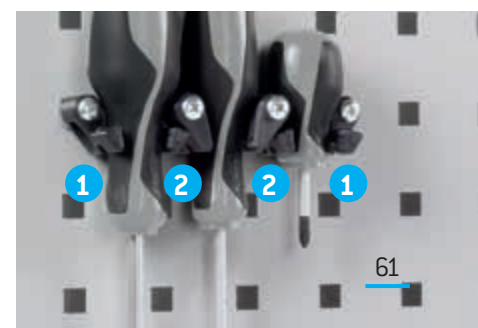
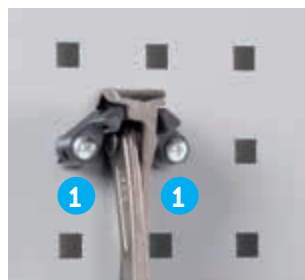
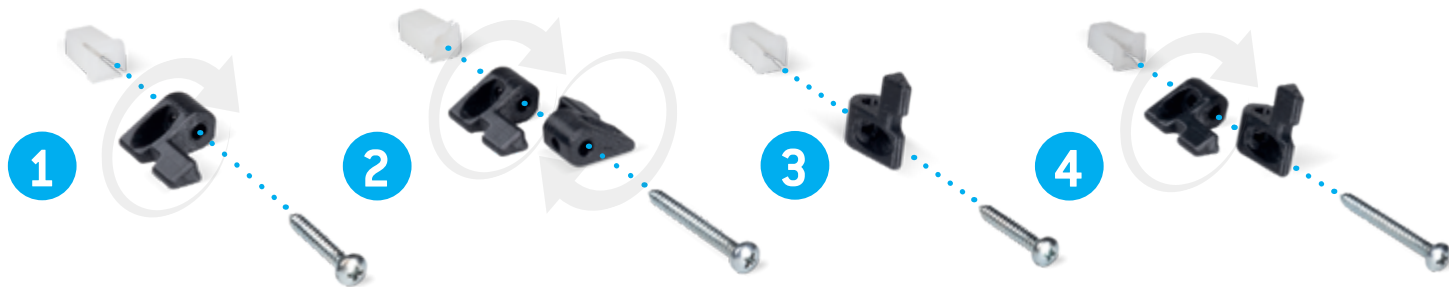

ACCESSORI UNIVERSALI



**FISSAGGIO SU
LEGNO INCLUSO**



**FISSAGGIO SU PANNELLO
FORATO INCLUSO**



**FISSAGGIO SU MURO
NON INCLUSO**

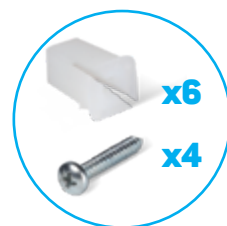

**SET DI FISSAGGIO
INCLUSO**



PORTA SILICONE INCLINATO A 2 POSTI

ART.	L mm	P mm	H mm	RAL	€
FBLIT008039 (IDEAONE05216)	150	71	96	7016	13,50



PORTA BOMBOLETTE INCLINATO A 2 POSTI

ART.	L mm	P mm	H mm	RAL	€
FBLIT007039 (IDEAONE05215)	188	111	172	7016	13,50



PORTA BOMBOLETTE A 6 POSTI

ART.	L mm	P mm	H mm	RAL	€
FBLIT010039 (IDEAONE05220)	455	75	167	7016	25,50



PORTA CONTENITORE CON SALVIETTE LAVAMANI

ART.	L mm	P mm	H mm	RAL	€
FBLIT006039 (IDEAONE05207)	910	-	-	7016	81,00

lunghezza cinghia 910 mm



PORTA ROTOLO CON CARTA Ø 240/300 mm

ART.	L mm	P mm	H mm	RAL	€
FBLIT004039 (IDEAONE05163)	285	180	200	7016	40,50



PORTA ROTOLO CON CARTA Ø 130 mm

ART.	L mm	P mm	H mm	RAL	€
FBLIT003039 (IDEAONE05162)	245	90	145	7016	30,00

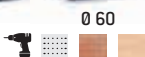
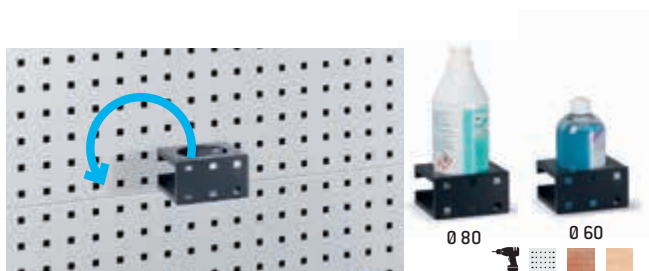

PORTA FLACONE IGIENIZZANTE REVERSIBILE

ART.	L mm	P mm	H mm	RAL	€
FBLIT002039 (IDEAONE05161)	114	100	62	7016	15,00



DISPENSER PER GUANTI

ART.	L mm	P mm	H mm	RAL	€
FBLIT005039 (IDEAONE05164)	247	82	132	7016	12,00



CALAMITE

ART.	pz. per confezione	Ø mm	colore	€
FBL95410000 (IDEAONE05108)	10	20	zincato	42,00

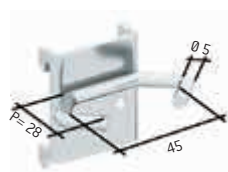
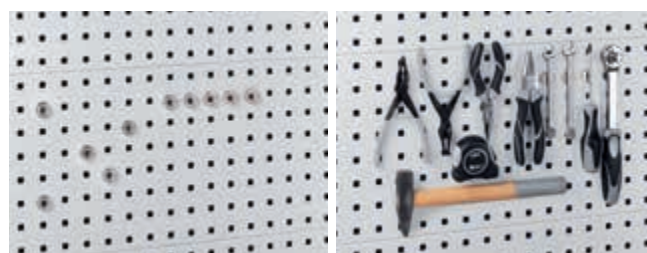

GANCIO CURVO

ART.	multiplo d'ordine	P mm	Ø mm	colore	€ cadauno
CMV10001 (IDEAONE05092)	10	28	5	zincato	1,80

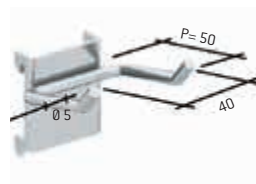

GANCIO ANGOLATO

ART.	multiplo d'ordine	P mm	Ø mm	colore	€ cadauno
CMV10016 (IDEAONE05093)	10	50	5	zincato	1,80



PORTA CACCIAVITI

ART.	multiplo d'ordine	Ø mm	colore	€ cadauno
CMV10022 (IDEAONE05094)	10	18	zincato	1,50

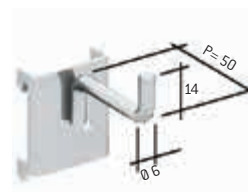

GANCIO SEMPLICE

ART.	multiplo d'ordine	P mm	Ø mm	colore	€ cadauno
CMV10036 (IDEAONE05095)	10	50	6	zincato	1,50



PENSILE CON PORTA BATTENTE REVERSIBILE

ART.	L mm	P mm	H mm	KG	RAL	€
FBL8015C000PD	460	250	456	25	7035+7016	99,00
FBL8015C00004	460	250	456	25	5012	96,00

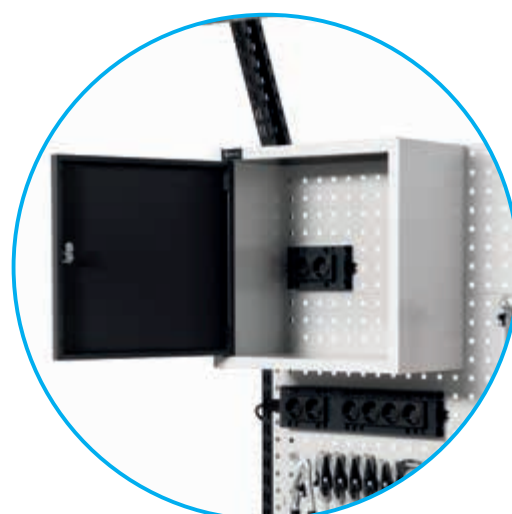

ESEMPIO DI APPLICAZIONE DEL PENSILE SU PANNELLO WORK LOOK CON PRESE ELETTRICHE IRON TEAM. IL PENSILE VIENE FORNITO SENZA CHIUSURA POSTERIORE



BARRA AGGANCIO CONTENITORI CON 4 CONTENITORI PICKING BOX MIS. 1

ART.	L mm	P mm	H mm	colore contenitori	€
FBLIT011000 (IDEAONE05221)	445	168	85	grigio	9,30
FBLIT012000 (IDEAONE05222)	445	168	85	nero	15,00



BARRA AGGANCIO CONTENITORI CON 3 CONTENITORI PICKING BOX MIS. 2

ART.	L mm	P mm	H mm	colore contenitori	€
FBLIT013000 (IDEAONE05223)	447	233	123	grigio	12,00
FBLIT014000 (IDEAONE05224)	447	233	123	nero	21,00



BARRA AGGANCIO CONTENITORI PICKING BOX

ART.	L mm	P mm	H mm	colore	€
FBLIT020099 (IDEAONE05210)	445	9	86	zincato	3,90



KIT STAFFE PORTA CONTENITORE

ART.	L mm	P mm	H mm	RAL	€
FBLIT018039 (IDEAONE05206)	910	-	-	7016	31,50

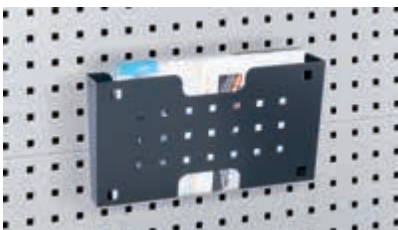

TASCA PORTA DOCUMENTI A4

ART.	L mm	P mm	H mm	RAL	€
FBLIT001039 (IDEAONE05158)	365	68	187	7016	18,00



KIT PRONTO SOCCORSO

ART.	L mm	P mm	H mm	colore	€
FBLIT024000 (IDEAONE05214)	90	256	190	arancione	27,00



PORTA ESTINTORE + ESTINTORE DA 2 kg

ART.	L mm	P mm	H mm	colore	€
FBLIT023000 (IDEAONE05213)	-	-	-	nero	51,00



SELLA REGGICAVI

ART.	L mm	P mm	H mm	RAL	€
FBLIT019039 (IDEAONE05208)	220	95	101	7016	21,00



CESTINO CAPACITÀ 30 LT

ART.	L mm	P mm	H mm	RAL	€
FBLIT025039 (IDEAONE05217)	388	278	394	7016	87,00



KIT PORTA VALIGETTA

ART.	L mm	P mm	H mm	RAL	€
FBLIT021039 (IDEAONE05211)	214/ 342	100	57/ 77	7016	42,00



VALIGETTA IN PLASTICA CON CONTENITORI

ART.	L mm	P mm	H mm	colore	€
FBLIT022001 (IDEAONE05212)	440	350	80	grigio	46,50



MENSOLA PICCOLA REVERSIBILE

ART.	L mm	P mm	H mm	RAL	€
FBLIT017039 (IDEAONE05205)	303	317	144	7016	21,00



MENSOLA GRANDE REVERSIBILE

ART.	L mm	P mm	H mm	RAL	€
FBLIT016039 (IDEAONE05204)	455	317	144	7016	22,50

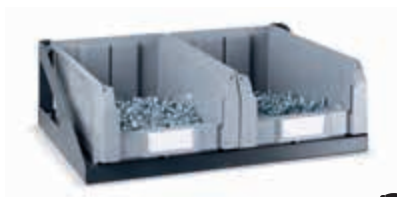

KIT 2 CONTENITORI PICKING BOX MIS. 3A2

ART.	L mm	P mm	H mm	colore	€
FBLIT027001 (IDEAONE05225)	200	350	145	grigio	13,50



KIT 10 CONTENITORI IN PLASTICA

ART.	L mm	P mm	H mm	colore	€
FBLIT028000 (IDEAONE05226)	388	278	394	-	10,50



MENSOLA PORTA OGGETTI REVERSIBILE

ART.	L mm	P mm	H mm	RAL	€
FBLIT015039 (IDEAONE05160)	456	160	40	7016	21,00



PORTA PUNTE IN ACCIAIO INOX

ART.	L mm	P mm	H mm	colore	€
FBLIT0260ZZ (IDEAONE05218)	155	84	39	acciaio	25,50



IL PORTA PUNTE PUÒ ESSERE UTILIZZATO ALL'INTERNO DELLA MENSOLA PORTA OGGETTI REVERSIBILE



BREVETTATO*

SUPPORTO PER INTERRUTTORE MAGNETOTERMICO

ART.	L mm	P mm	H mm	RAL	€
FBLET003039 (IDEAONE05203)	159	32	92	7016	13,50



MAGNETOTERMICO DIFFERENZIALE 2P+T 16A, 30mA TYPE A

ART.	L mm	P mm	H mm	colore	€
FBLET012007 (IDEAONE05178)	159	59	90	nero	90,00



BREVETTATO*

SUPPORTO MULTIPRESA A 2 SCOMPARTI

ART.	L mm	P mm	H mm	RAL	€
FBLET001039 (IDEAONE05201)	148	32	92	7016	13,50



BREVETTATO*

SUPPORTO MULTIPRESA A 4 SCOMPARTI

ART.	L mm	P mm	H mm	RAL	€
FBLET002039 (IDEAONE05202)	249	32	92	7016	15,00



MULTIPRESA A 2 SCOMPARTI

ART.	L mm	P mm	H mm	tipo presa	colore	€
FBLET004007 (IDEAONE05165)	148	59	46	SCHUKO	nero	19,50
FBLET006007 (IDEAONE05167)	148	59	46	CH	nero	40,50
FBLET008007 (IDEAONE05169)	148	59	46	GB	nero	33,00
FBLET010007 (IDEAONE05171)	148	59	46	FR	nero	19,50



MULTIPRESA A 4 SCOMPARTI

ART.	L mm	P mm	H mm	tipo presa	colore	€
FBLET005007 (IDEAONE05166)	248	59	46	SCHUKO	nero	25,50
FBLET007007 (IDEAONE05168)	248	59	46	CH	nero	46,50
FBLET009007 (IDEAONE05170)	248	59	46	GB	nero	54,00
FBLET011007 (IDEAONE05172)	248	59	46	FR	nero	25,50



CAVO DI COLLEGAMENTO WIELAND CON SPINE IN/OUT

ART.	L mm	colore	€
FBLET013007 (IDEAONE05173)	100	nero	18,00



CAVO DI COLLEGAMENTO WIELAND - SCHUKO/FR

ART.	L mm	tipo presa	colore	€
FBLET016007 (IDEAONE05179)	3000	FR	nero	18,00
FBLET017007 (IDEAONE05180)	3000	GB	nero	21,00
FBLET018007 (IDEAONE05181)	3000	CH	nero	19,50



CONNETTORE AD H WIELAND 1 INPUT - 2 OUTPUT

ART.	L mm	colore	€
FBLET015007 (IDEAONE05177)	100	nero	18,00



CAVO DI COLLEGAMENTO WIELAND CON SPINE IN/OUT

ART.	L mm	colore	€
FBLET014007 (IDEAONE05174)	1500	nero	19,50





PRESA USB DATI

ART.	Ø mm	H mm	colore	€
FBLET019007	60	54	nero	126,00



PRESA USB RICARICA

ART.	Ø mm	L mm	H mm	colore	€
FBLET020007	60	200	54	nero	103,50





LAMPADA SINGOLA

ART.	L mm	W	K	RAL	€
FBL99400008 (IDEAONE05287)	1000	12	3000	7035	90,00
FBL99450008 (IDEAONE05289)	1500	14	3000	7035	99,00



LAMPADA DOPPIA

ART.	L mm	W	K	RAL	€
FBL99400108 (IDEAONE05288)	1000	12	3000	7035	108,00
FBL99450108 (IDEAONE05290)	1500	14	3000	7035	121,50



Ogni lampada è fornita con un KIT DI FISSAGGIO, composto da: staffe, calamite e viti per l'applicazione ai pannelli forati, pannelli in legno, binario aereo e muro.



ESEMPIO DI FISSAGGIO BINARIO AEREO



ESEMPIO DI FISSAGGIO A PANNELLO FORATO TRAMITE STAFFE



ESEMPIO DI FISSAGGIO CON CALAMITA



MASTER STANDARD - FLEXA

ARMADI A CASSETTI



I CASSETTI DEGLI ARMADI PORTAUTENSILI FAMI PRESENTANO FONDO FORATO E FESSURE LATERALI PER PERSONALIZZARE L'ORGANIZZAZIONE INTERNA DEL CASSETTO CON IL MATERIALE DI SEPARAZIONE

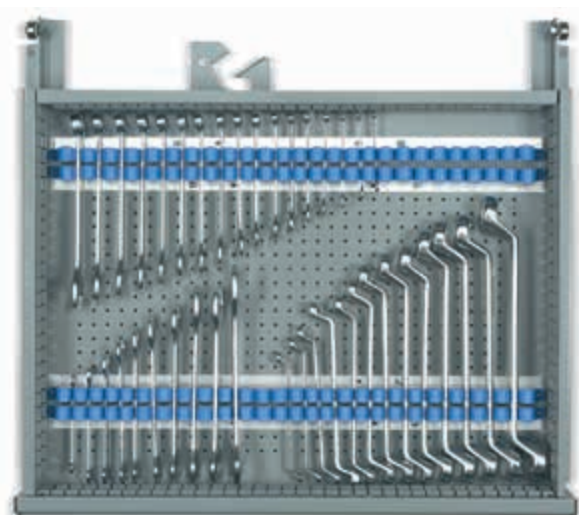

PORTATA CASSETTI
DA 50 A 200 KG

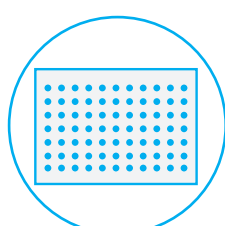

CASSETTI
FORATI

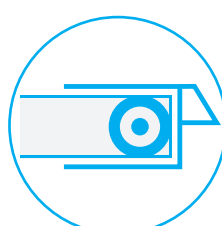

CUSCINETTI A
SFERA

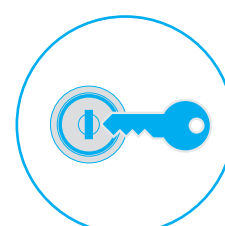

CHIUSURA
A CHIAVE

UN ARMADIO PER OGNI ESIGENZA



MASTER

✓ ESTRAZIONE TOTALE
100%



✓ PORTATA FINO A
100 kg



SISTEMA ANTIELUSIVO

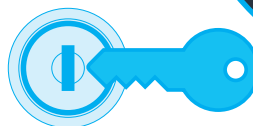

STANDARD

✓ ESTRAZIONE PARZIALE
87%



✓ ESTRAZIONE TOTALE
100%

✓ PORTATA
100 kg



✓ PORTATA
200 kg

FLEXA

✓ ESTRAZIONE TOTALE
100%



✓ PORTATA
70 KG



MASTER 36x36 EH

CASSETTIERA L=714 mm - CASSETTI AD ESTRAZIONE TOTALE

CONFIGURE



BREVETTATO*

A

CONFIGURE



BREVETTATO*

B

armadio					cassetti							RAL	€
ART.	rif.	L mm	P mm	H mm	n.	H 75 mm	H 100 mm	H 150 mm	H 200 mm	KG			
M33A100C010BLPD (IDEAONE01038)	A	714	726	1000	9	-	9	-	-	50-75-100	100-96-92%	7035+7016	1.062,00
M33A100C010BL04 (IDEAONE01039)	A	714	726	1000	9	-	9	-	-	50-75-100	100-96-92%	5012	990,00
M33A100C010AWPD (IDEAONE01040)	B	714	726	1000	7	2	1	3	1	50-75-100	100-96-92%	7035+7016	924,00
M33A100C010AW04 (IDEAONE01041)	B	714	726	1000	7	2	1	3	1	50-75-100	100-96-92%	5012	873,00

MANIGLIE PERSONALIZZABILI



UNA MINIERA DI INFORMAZIONI

Inserisci nella maniglia codici a barre, etichette o immagini per **conoscere** velocemente il **contenuto** di ogni singolo **cassetto**.

MAGGIOR CONO VISIVO



VISUALE COMPLETA

Estrazione e sagomatura dell'armadio ti consentono di **vedere completamente l'interno** dei **cassetti** più alti.

SISTEMA ANTIELUSIVO



SICUREZZA AL PRIMO POSTO

Al contrario di altri armadi presenti in commercio, il **sistema di chiusura brevettato** non consente allo scassinatore di eludere la chiusura. In caso di apertura forzata l'effrazione è sempre visibile.

ESTRAZIONE TOTALE



LIBERTÀ NELLA CONFIGURAZIONE

Modifica velocemente e facilmente l'**estrazione** del cassetto per **aumentare** la **portata** fino a **100 kg**.

GUIDE AD ALTE PRESTAZIONI



CORRERE SENZA PROBLEMI

Le guide lunghe come i cassetti permettono di spostare il **cuscinetto** nella parte **frontale** dell'armadio aumentando **visibilità, portata** ed **estrazione**.

CASSETTI FORATI

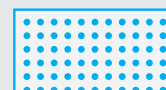

ORGANIZZAZIONE AL MILLIMETRO

Fori e scanalature sui cassetti facilitano la **suddivisione** interna del **cassetto** per una **perfetta organizzazione** di utensili e materiali.

MASTER 36x36 EH COMPONENTI

MATERIALE DI SEPARAZIONE PER CASSETTIERA L=714 mm



PIANO SUPERIORE A 3 BORDI

ART.	L mm	P mm	H mm	colore	€
M33T023AG003107 (IDEAONE01042)	714	726	23	nero	81,00



ART.	per altezza frontale mm	€
FFH20051500 (IDEAONE01043)	50-300	24,90

Composto da: 16 divisori 2 canali, 35 divisori trasversali 73 mm



ART.	per altezza frontale mm	€
FFH20051600 (IDEAONE01044)	50-300	26,40

Composto da: 16 divisori 3 canali, 50 divisori trasversali 47 mm



ART.	per altezza frontale mm	€
FFH20051700 (IDEAONE01045)	50-300	31,80

Composto da: 16 divisori 4 canali, 65 divisori trasversali 36 mm



ART.	per altezza frontale mm	€
FFH20071200 (IDEAONE01046)	75	29,40

Composto da: 16 cassette divisorio 75x75 mm, 16 cassette divisorio 150x75 mm, 4 cassette divisorio 150x150 mm



ART.	per altezza frontale mm	€
FFH20071300 (IDEAONE01047)	75	26,40

FFH20101300 (IDEAONE01048)	100	31,50
--------------------------------------	-----	-------

Composto da: 16 cassette divisorio 150x75 mm, 8 cassette divisorio 150x150 mm



ART.	per altezza frontale mm	€
FFH20070600 (IDEAONE01049)	75	8,40

FFH20100600 (IDEAONE01050)	100	10,50
--------------------------------------	-----	-------

FFH20150600 (IDEAONE01051)	150	15,00
--------------------------------------	-----	-------

FFH20200600 (IDEAONE01052)	200	20,10
--------------------------------------	-----	-------

Composto da: 2 divisori longitudinali fessurati 610 mm, 3 divisori trasversali 200 mm

STANDARD 36x36 EH

CASSETTIERA L=717 mm - CASSETTI AD ESTRAZIONE SEMPLICE - ESTRAZIONE TOTALE



A



B

armadio					cassetti								RAL	€
ART.	rif.	L mm	P mm	H mm	n.	H 75 mm	H 100 mm	H 150 mm	H 200 mm	KG	↓			
FAG204012PD	A	717	726	1000	7	2	1	3	1	80-100	87%	7035+7016	771,00	
FAG20401208 <small>(IDEAONE01028)</small>	A	717	726	1000	7	2	1	3	1	80-100	87%	7035	714,00	
FAG20401204 <small>(IDEAONE01011)</small>	A	717	726	1000	7	2	1	3	1	80-100	87%	5012	714,00	
FAG204010PD	B	717	726	1000	9	-	9	-	-	100	87%	7035+7016	870,00	
FAG20401008 <small>(IDEAONE01033)</small>	B	717	726	1000	9	-	9	-	-	100	87%	7035	798,00	
FAG20401004 <small>(IDEAONE01009)</small>	B	717	726	1000	9	-	9	-	-	100	87%	5012	798,00	



C

armadio					cassetti								RAL	€
ART.	rif.	L mm	P mm	H mm	n.	H 75 mm	H 100 mm	H 150 mm	H 200 mm	KG	↓			
FAG204060PD	C	717	726	1000	9	-	9	-	-	200	100%	7035+7016	1.140,00	
FAG20406008 <small>(IDEAONE01032)</small>	C	717	726	1000	9	-	9	-	-	200	100%	7035	1.074,00	
FAG20406004 <small>(IDEAONE01020)</small>	C	717	726	1000	9	-	9	-	-	200	100%	5012	1.074,00	

STANDARD 36x36 EH COMPONENTI

MATERIALE DI SEPARAZIONE PER CASSETTIERA L=717 mm



PIANO SUPERIORE A 3 BORDI

ART.	L mm	P mm	H mm	colore	€
FAG90030107	717	726	20	nero	81,00

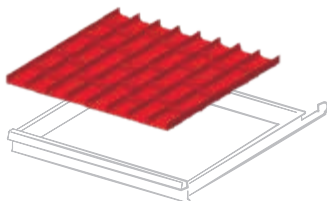

ART.	per altezza frontale mm	€
FFH20051500 (IDEAONE01043)	50-300	24,90

Composto da: 16 divisori 2 canali, 35 divisori trasversali 73 mm

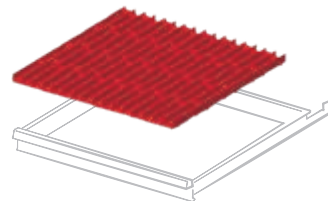

ART.	per altezza frontale mm	€
FFH20051600 (IDEAONE01044)	50-300	26,40

Composto da: 16 divisori 3 canali, 50 divisori trasversali 47 mm

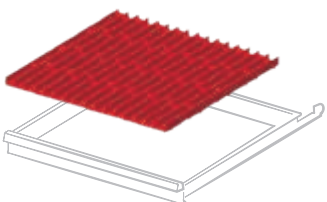

ART.	per altezza frontale mm	€
FFH20051700 (IDEAONE01045)	50-300	31,80

Composto da: 16 divisori 4 canali, 65 divisori trasversali 36 mm

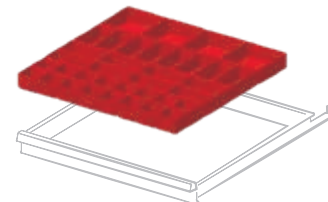

ART.	per altezza frontale mm	€
FFH20071200 (IDEAONE01046)	75	29,40

Composto da: 16 cassette divisorio 75x75 mm, 16 cassette divisorio 150x75 mm, 4 cassette divisorio 150x150 mm

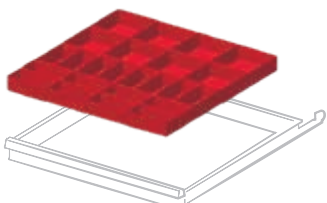

ART.	per altezza frontale mm	€
FFH20071300 (IDEAONE01047)	75	26,40

Composto da: 16 cassette divisorio 150x75 mm, 8 cassette divisorio 150x150 mm

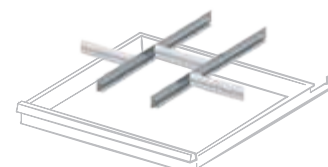

ART.	per altezza frontale mm	€
FFH20070600 (IDEAONE01049)	75	8,40
FFH20100600 (IDEAONE01050)	100	10,50
FFH20150600 (IDEAONE01051)	150	15,00
FFH20200600 (IDEAONE01052)	200	20,10

Composto da: 2 divisori longitudinali fessurati 610 mm, 3 divisori trasversali 200 mm

FLEXA 36x27 EH

CASSETTIERA L=717 mm - CASSETTI AD ESTRAZIONE TOTALE

CONFIGURE



A

CONFIGURE



B

armadio					cassetti							RAL	€
ART.	rif.	L mm	P mm	H mm	n.	H 75 mm	H 100 mm	H 150 mm	H 200 mm	KG			
FDF109054PD	A	717	600	1000	7	2	1	3	1	70	100%	7035+7016	690,00
FDF10905408 (IDEAONE01031)	A	717	600	1000	7	2	1	3	1	70	100%	7035	630,00
FDF10905404 (IDEAONE01001)	A	717	600	1000	7	2	1	3	1	70	100%	5012	630,00
FDF109056PD	B	717	600	1000	9	-	9	-	-	70	100%	7035+7016	798,00
FDF10905608 (IDEAONE01030)	B	717	600	1000	9	-	9	-	-	70	100%	7035	732,00
FDF10905604 (IDEAONE01023)	B	717	600	1000	9	-	9	-	-	70	100%	5012	732,00

CONFIGURE



C

armadio					cassetti				ruote					RAL	€			
ART.	rif.	L mm	P mm	H mm	n.	H 100 mm	H 200 mm	KG		Ø	KG	H mm	materiale					
FDGD56001PD	C	794	600	852	5	4	1	70	100%	100	225	130	gomma standard	1	1	2	7035+7016	621,00
FDGD5600108 (IDEAONE02017)	C	794	600	852	5	4	1	70	100%	100	225	130	gomma standard	1	1	2	7035	585,00
FDGD5600104 (IDEAONE02005)	C	794	600	852	5	4	1	70	100%	100	225	130	gomma standard	1	1	2	5012	585,00

ruota girevole

ruota girevole con freno

ruota fissa

FLEXA 36x27 EH COMPONENTI

MATERIALE DI SEPARAZIONE PER CASSETTIERA L=717 mm



PIANO SUPERIORE A 4 BORDI

ART.	L mm	P mm	H mm	colore	€
FDF99400107	717	600	22	nero	63,00

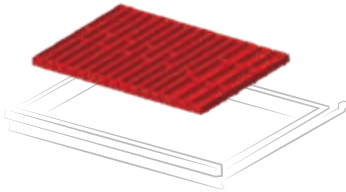

ART.	per altezza frontale mm	€
FFH10051000	50-300	27,00

Composto da 9 divisori 4 canali, 3 divisori 3 canali, 36 divisori trasversali 36 mm, 12 divisori trasversali 47 mm

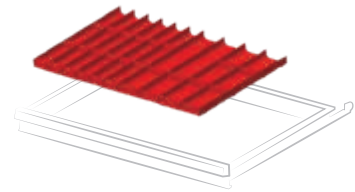

ART.	per altezza frontale mm	€
FFH10051300	50-300	22,50

Composto da 6 divisori 3 canali, 6 divisori 2 canali, 18 divisori trasversali 47 mm, 12 divisori trasversali 73 mm

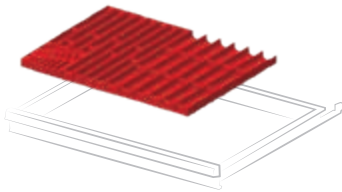

ART.	per altezza frontale mm	€
FFH10051500	50-300	25,80

Composto da 5 divisori 4 canali, 6 divisori 3 canali, 20 divisori trasversali 36 mm, 20 divisori trasversali 47 mm, 1 porta chiavi a brugola 150x150 mm

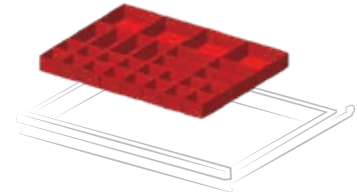

ART.	per altezza frontale mm	€
FFH10071800	75	24,90

Composto da 16 cassette divisorio 75x75 mm, 8 cassette divisorio 150x75 mm, 4 cassette divisorio 150x150 mm

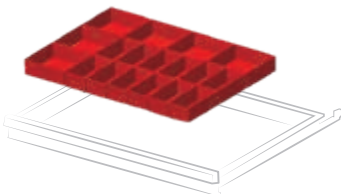

ART.	per altezza frontale mm	€
FFH10071600	75	22,50
FFH10101600	100	28,50

Composto da 12 cassette divisorio 150x75 mm, 6 cassette divisorio 150x150 mm

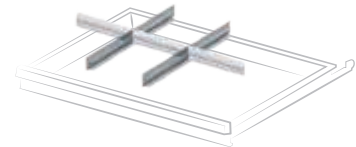

ART.	per altezza frontale mm	€
FFH10070500	75	12,00
FFH10100500	100	11,10
FFH10150500	150	14,40
FFH10200500	200	20,10

Composto da 2 divisori longitudinali fessurati 455 mm, 3 divisori trasversali 200 mm

FLEXA 54x27 EH

CASSETTIERA L=1023 mm - CASSETTI AD ESTRAZIONE TOTALE

CONFIGURE 



D

CONFIGURE 



E

ART.	armadio				cassetti								RAL	€
	rif.	L mm	P mm	H mm	n.	H 75 mm	H 100 mm	H 150 mm	H 200 mm	KG				
FDL109054PD	D	1023	600	1000	7	2	1	3	1	50	100%	7035+7016	846,00	
FDL10905408 (IDEAONE01034)	D	1023	600	1000	7	2	1	3	1	50	100%	7035	777,00	
FDL10905404 (IDEAONE01017)	D	1023	600	1000	7	2	1	3	1	50	100%	5012	777,00	
FDL109056PD	E	1023	600	1000	9	-	9	-	-	50	100%	7035+7016	990,00	
FDL10905608 (IDEAONE01036)	E	1023	600	1000	9	-	9	-	-	50	100%	7035	900,00	
FDL10905604 (IDEAONE01035)	E	1023	600	1000	9	-	9	-	-	50	100%	5012	900,00	



FLEXA 54x27 EH COMPONENTI

MATERIALE DI SEPARAZIONE PER CASSETTIERA L=1023 mm



PIANO SUPERIORE A 3 BORDI

ART.	L mm	P mm	H mm	colore	€
FDL91500107	1023	598	20	nero	81,00

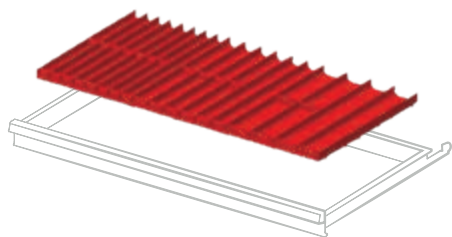

ART.	per altezza frontale mm	€
FFH40051200	50-300	28,50

Set composto da: 6 divisori 4 canali, 6 divisori 3 canali, 6 divisori 2 canali, 15 divisori trasversali 36 mm, 10 divisori trasversali 47 mm, 6 divisori trasversali 73 mm

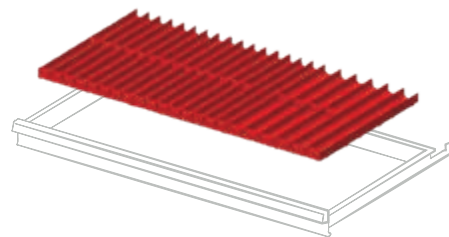

ART.	per altezza frontale mm	€
FFH40051500	50-300	30,90

Set composto da: 12 divisori 4 canali, 6 divisori 3 canali, 30 divisori trasversali 36 mm, 10 divisori trasversali 47 mm

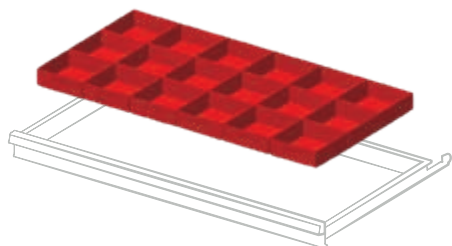

ART.	per altezza frontale mm	€
FFH40071100	75	27,00
FFH40101100	100	32,10

Set composto da: 18 cassette divisorio 150x150 mm

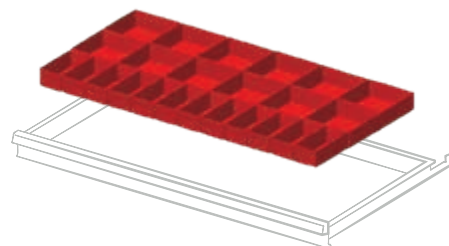

ART.	per altezza frontale mm	€
FFH40071300	75	28,50
FFH40101300	100	34,50

Set composto da: 12 cassette divisorio 150x75 mm, 12 cassette divisorio 150x150 mm

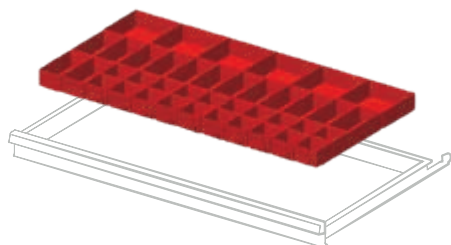

ART.	per altezza frontale mm	€
FFH40071600	75	33,00

Set composto da: 20 cassette divisorio 75x75 mm, 14 cassette divisorio 150x75 mm, 6 cassette divisorio 150x150 mm

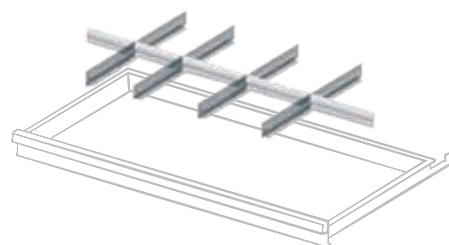

ART.	per altezza frontale mm	€
FFH40070500	75	18,90
FFH40100500	100	15,60
FFH40150500	150	22,20
FFH40200500	200	33,90

Set composto da: 4 divisori longitudinali fessurati 455 mm, 2 divisori trasversali 149 mm, 3 divisori trasversali 200 mm

MASTER CS ARMADIO PORTA COMPUTER



[CONFIGURE](#)

BREVETTATO*

ART.	L mm	P mm	H mm	RAL	€
MASTERCS01	791	598	1731	7035	1.281,30

COMPOSTO DA:

- 1 modulo base con 1 cassetto
- 1 modulo porta con finestra in policarbonato
- 1 piano estraibile flessibile con maniglia
- 1 multipresa Schuko a 4 scomparti
- 1 cavo di collegamento Wieland Schuko/FR
- 1 supporto presa
- 1 ventola 230V senza griglia con spina Schuko
- 1 kit ruote in nylon Ø 100 mm
- 1 maniglia a tubo



MODULO PORTA CON FINESTRA IN POLICARBONATO

ART.	L mm	P mm	H mm	RAL	€
FAS1450C01008 (IDEAONE03076)	715	250	650	7035	270,00

Completo di viti per il fissaggio al modulo base - Possibilità di inserimento video fino a 24"



MODULO TAPPARELLA

ART.	L mm	P mm	H mm	RAL	€
FAS1450C02008 (IDEAONE03077)	714	247	650	7035	300,00

Completo di viti per il fissaggio al modulo base - Possibilità di inserimento video fino a 24"

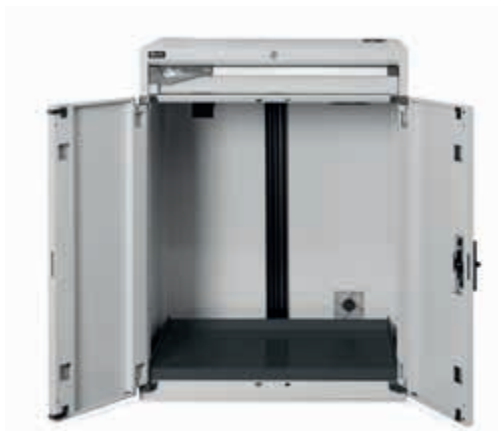

[CONFIGURE](#)

BREVETTATO*



piano porta tastiera

MODULO BASE CON 1 CASSETTO

ART.	L mm	P mm	H mm	piani regolabili	piani per tastiera	cassetti	RAL	€
FAS1400C00508	714	598	950	1	1	1	7035	789,00

MASTER CS COMPONENTI



ruote in gomma antitraccia sintetica

KIT RUOTE

ART.	Ø	KG	H mm	materiale				€
FKRU1252101	125	300	155	gomma antitraccia sintetica	-	2	2	42,00
FKRV1001107	100	450	128	nylon	1	1	2	37,20

ruota girevole

ruota girevole con freno

ruota fissa



PIANO ESTRAIBILE FLESSIBILE CON MANIGLIA 36x27 EH

ART.	L mm	P mm	H mm	RAL	€
M32C05701101F39	600	447	70	7016	93,60



PIANO REGOLABILE CON SUPPORTI 36x27 EH

ART.	L mm	P mm	H mm	RAL	€
M32PR2500001139	657	478	60	7016	55,50



MANIGLIA A TUBO

ART.	L mm	P mm	H mm	RAL	€
M02R00000000007	543	80	46	9005	12,00



VENTOLA 230V SENZA GRIGLIA CON SPINA SCHUKO

ART.	colore	€
FAS32200100 (IDEAONE03066)	nero	28,50



TOP A 3 BORDI RIVESTITO IN GOMMA 36x27 EH

ART.	L mm	P mm	H mm	RAL	€
M32T023AG007107	714	573	23	9005	58,20



SUPPORTO PRESA

ART.	L mm	P mm	H mm	colore	€
FAS30210099	550	10	67	zincato	7,50

IRON TEAM ELECTRIC

vedi pag. 68-69



FBLETO12007
(IDEAONE05178)



FBLETO04007
(IDEAONE05165)



FBLETO05007
(IDEAONE05166)



FBLETO16007
(IDEAONE05179)

SUPPORTO ZINCATO

ESEMPIO 1 multipresa 4 posti

SUPPORTO ZINCATO

ESEMPIO 2 multipresa 2 posti multipresa 4 posti

SUPPORTO ZINCATO

ESEMPIO 3 magneto-termico multipresa 4 posti

STANDARD CS ARMADIO PORTA COMPUTER

CONFIGURE



ART.	L mm	P mm	H mm	RAL	€
STANDARDCS01	717	635	1690	7035	839,70

COMPOSTO DA:

- 1 armadio porta computer STANDARD CS
- 1 piano estraibile ad estrazione semplice
- 1 multipresa Schuko a 4 scomparti
- 1 cavo di collegamento Wieland Schuko/FR
- 1 supporto presa
- 1 ventola 230 V senza griglia con spina Schuko
- 1 kit ruote in nylon Ø 100 mm
- 1 maniglia a tubo

CONFIGURE



ARMADIO PORTA COMPUTER STANDARD CS

ART.	L mm	P mm	H mm	piani regolabili	piani estraibili per tastiera	RAL	€
FAS1600C00208	717	635	1560	1	1	7035	660,00
FAS1600C00204	717	635	1560	1	1	5012	660,00

Possibilità di inserimento video fino a 21"

STANDARD CS COMPONENTI



ruote in gomma antitraccia sintetica

KIT RUOTE

ART.	Ø	KG	H mm	materiale				€
FKRU1252101	125	300	155	gomma antitraccia sintetica	-	2	2	42,00
FKRV1001107	100	450	128	nylon	1	1	2	37,20

ruota girevole

ruota girevole con freno

ruota fissa

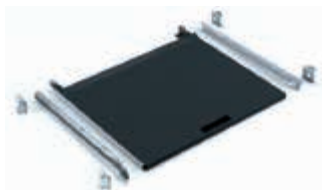

PIANO ESTRAIBILE AD ESTRAZIONE SEMPLICE

ART.	L mm	P mm	H mm	RAL	€
FAS2360S039	650	585	25	7016	51,00



PIANO REGOLABILE

ART.	L mm	P mm	H mm	RAL	€
FAS2040S139	690	595	35	7016	42,00



MANIGLIA A TUBO

ART.	L mm	P mm	H mm	RAL	€
FCL09950007	516	80	46	9005	12,00



VENTOLA 230V SENZA GRIGLIA CON SPINA SCHUKO

ART.	colore	€
FAS32200100 (IDEAONE03066)	nero	28,50



COPPIA ZOCCOLI PER TRANSPALLET

ART.	L mm	P mm	H mm	RAL	€
FRR16250007	56	607	100	9005	33,00



SUPPORTO PRESA

ART.	L mm	P mm	H mm	colore	€
FAS30210099	550	10	67	zincato	7,50

IRON TEAM ELECTRIC

vedi pag. 68-69



FBLETO12007
(IDEAONE05178)



FBLETO04007
(IDEAONE05165)



FBLETO05007
(IDEAONE05166)



FBLETO16007
(IDEAONE05179)

SUPPORTO ZINCATO

ESEMPIO 1 multipresa 4 posti

SUPPORTO ZINCATO

ESEMPIO 2 multipresa 2 posti

multipresa 4 posti

SUPPORTO ZINCATO

ESEMPIO 3 magneto-termico

multipresa 4 posti

PERFOM

ARMADI A PORTE BATTENTE

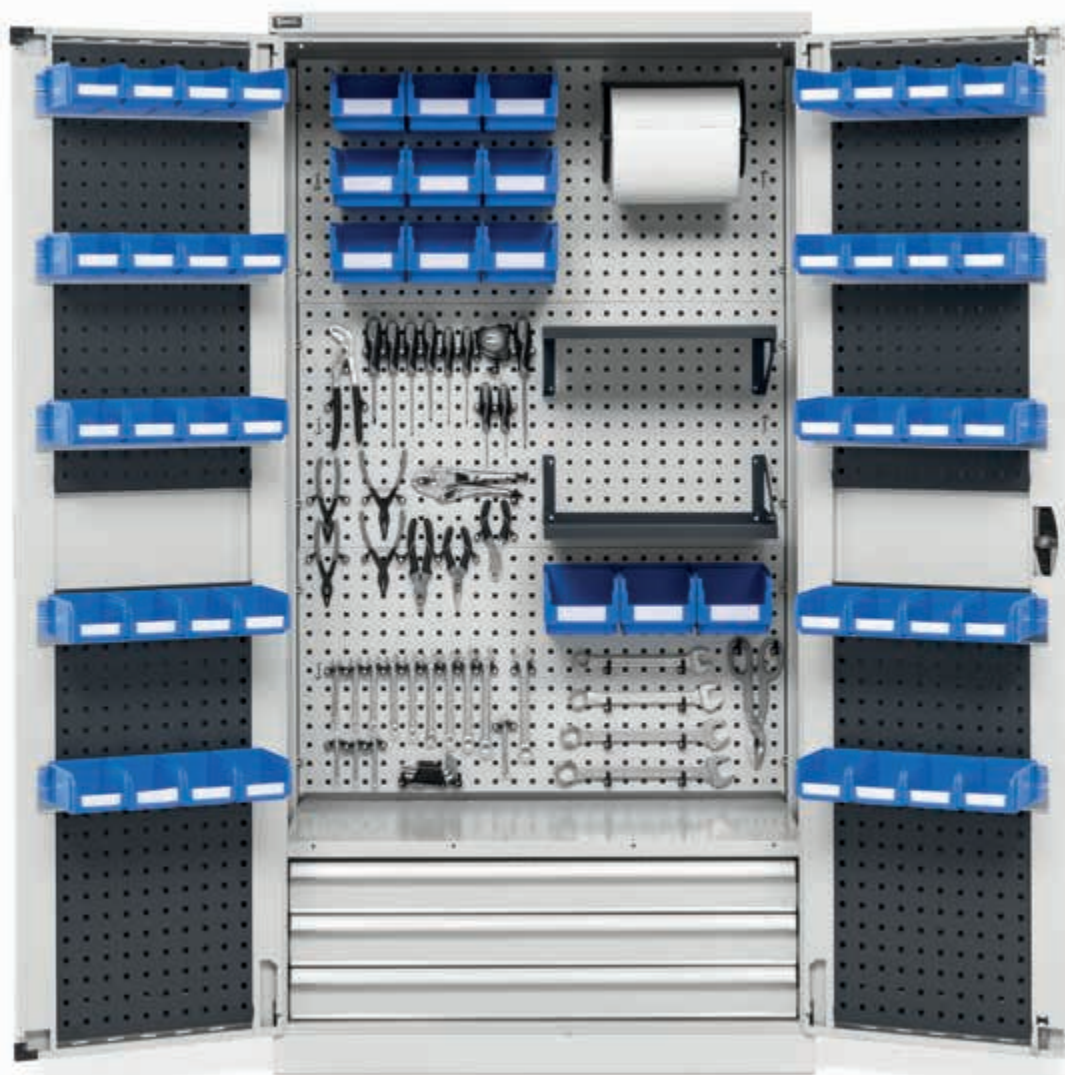

CONFIGURABILE



PORTATA 800 KG

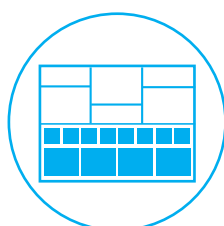

MATERIALE DI
SEPARAZIONE

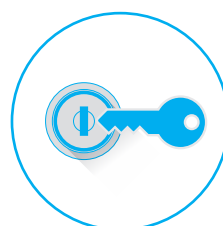

CHIUSURA
A CHIAVE

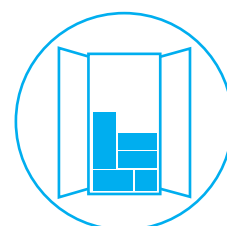

ARMADIO MONTATO
+ ACCESSORI CONFEZIONATI
ALL'INTERNO DELL'ARMADIO

PERFOM 1193x555x1000

ARMADI A PORTE BATTENTE 64x27 EH



CONFIGURE



ART.	L mm	P mm	H mm	KG	RAL	€
PERFOM15001	1193	555	1000	800	7035+7016	457,50
PERFOM15002	1193	555	1000	800	7035	457,50
PERFOM15003	1193	555	1000	800	5012	457,50

COMPOSTO DA:

- 1 armadio a porte battente
- 1 kit 2 piani fessurati



CONFIGURE



ART.	L mm	P mm	H mm	KG	RAL	€
PERFOM15004	1193	555	1000	800	7035+7016	577,50
PERFOM15005	1193	555	1000	800	7035	577,50
PERFOM15006	1193	555	1000	800	5012	577,50

COMPOSTO DA:

- 1 armadio a porte battente
- 1 kit 2 piani fessurati
- 1 cassetto ad estrazione telescopica



CONFIGURE



ART.	L mm	P mm	H mm	KG	RAL	€
PERFOM15007	1193	555	1000	800	7035+7016	697,50
PERFOM15008	1193	555	1000	800	7035	697,50
PERFOM15009	1193	555	1000	800	5012	697,50

COMPOSTO DA:

- 1 armadio a porte battente
- 1 kit 2 piani fessurati
- 2 cassetti ad estrazione telescopica



CONFIGURE



ART.	L mm	P mm	H mm	KG	RAL	€
PERFOM15010	1193	555	1000	800	7035+7016	790,50
PERFOM15011	1193	555	1000	800	7035	790,50
PERFOM15012	1193	555	1000	800	5012	790,50

COMPOSTO DA:

- 1 armadio a porte battente
- 1 kit 1 piano fessurato
- 3 cassetti ad estrazione telescopica

PERFOM 1193x555x2000

ARMADI A PORTE BATTENTE 64x27 EH



[CONFIGURE](#)

ART.	L mm	P mm	H mm	KG	RAL	€
PERFOM17001	1193	555	2000	800	7035+7016	576,00
PERFOM17002	1193	555	2000	800	7035	576,00
PERFOM17003	1193	555	2000	800	5012	576,00

COMPOSTO DA:

- 1 armadio a porte battente
- 2 kit 2 piani fessurati



[CONFIGURE](#)

ART.	L mm	P mm	H mm	KG	RAL	€
PERFOM17004	1193	555	2000	800	7035+7016	936,00
PERFOM17005	1193	555	2000	800	7035	936,00
PERFOM17006	1193	555	2000	800	5012	936,00

COMPOSTO DA:

- 1 armadio a porte battente
- 2 kit 2 piani fessurati
- 3 cassetti ad estrazione telescopica



[CONFIGURE](#)

ART.	L mm	P mm	H mm	KG	RAL	€
PERFOM17007	1193	555	2000	800	7035+7016	1.600,50
PERFOM17008	1193	555	2000	800	7035	1.600,50
PERFOM17009	1193	555	2000	800	5012	1.600,50

COMPOSTO DA:

- 1 armadio a porte battente
- 1 kit 2 piani fessurati
- 9 cassetti ad estrazione telescopica

PERFOM 1023x555x1000

ARMADI A PORTE BATTENTE 54x27 EH



CONFIGURE 



CONFIGURE 



CONFIGURE 



CONFIGURE 

BREVETTATO*

ART.	L mm	P mm	H mm	KG	RAL	€
PERFOM12001	1023	555	1000	800	7035+7016	381,00
FAA1220C00108	1023	555	1000	800	7035	381,00
FAA1220C00104	1023	555	1000	800	5012	381,00

COMPOSTO DA:

- 1 armadio a porte battente
- 1 kit 2 piani fessurati

ART.	L mm	P mm	H mm	KG	RAL	€
PERFOM12004	1023	555	1000	800	7035+7016	450,00
PERFOM12005	1023	555	1000	800	7035	450,00
PERFOM12006	1023	555	1000	800	5012	450,00

COMPOSTO DA:

- 1 armadio a porte battente
- 1 kit 2 piani fessurati
- 1 cassetto ad estrazione semplice

ART.	L mm	P mm	H mm	KG	RAL	€
PERFOM12007	1023	555	1000	800	7035+7016	565,80
PERFOM12008	1023	555	1000	800	7035	565,80
PERFOM12009	1023	555	1000	800	5012	565,80

COMPOSTO DA:

- 1 armadio a porte battente
- 1 kit 1 piano fessurato
- 3 cassette ad estrazione semplice

ART.	L mm	P mm	H mm	KG	RAL	€
PERFOM12010	1023	555	1000	800	7035+7016	631,50
PERFOM12011	1023	555	1000	800	7035	631,50
PERFOM12012	1023	555	1000	800	5012	631,50

COMPOSTO DA:

- 1 armadio a porte battente fessurate
- 1 kit 2 piani-pannelli forati
- 1 canaletta elettrica per multiprese
- 1 magnetotermico differenziale
- 1 multipresa Schuko a 4 scomparti
- 2 multiprese Schuko a 2 scomparti
- 1 cavo di collegamento Wieland Shuko/FR

PERFOM 1023x555x1000

ARMADI A PORTE BATTENTE 54x27 EH



CONFIGURE



BREVETTATO*

ART.	L mm	P mm	H mm	KG	RAL	€
PERFOM12013	1023	555	1000	800	1004	448,80
PERFOM12014	1023	555	1000	800	7035+7016	448,80
PERFOM12015	1023	555	1000	800	7035	448,80
PERFOM12016	1023	555	1000	800	5012	448,80

COMPOSTO DA:

- 1 armadio a porte battente fessurate
- 1 kit 1 piano fessurato
- 1 vasca stagna esterna raccolta liquidi (capacità 59 litri)



vedi pag. 3



CONFIGURE



ART.	L mm	P mm	H mm	KG	RAL	€
PERFOM12017	1023	555	1000	800	1004	435,00
PERFOM12018	1023	555	1000	800	7035+7016	435,00
PERFOM12019	1023	555	1000	800	7035	435,00
PERFOM12020	1023	555	1000	800	5012	435,00

COMPOSTO DA:

- 1 armadio a porte battente fessurate
- 1 kit 2 vasche tenuta stagna complete di ganci (capacità 19 litri)



vedi pag. 3



CONFIGURE



ART.	L mm	P mm	H mm	KG	RAL	€
PERFOM12021	1023	555	1000	800	3020	381,00
PERFOM12022	1023	555	1000	800	7035+7016	381,00
PERFOM12023	1023	555	1000	800	7035	381,00
PERFOM12024	1023	555	1000	800	5012	381,00

COMPOSTO DA:

- 1 armadio a porte battente fessurate
- 1 kit 2 piani fessurati



PERFOM 1023x555x2000

ARMADI A PORTE BATTENTE 54x27 EH



[CONFIGURE](#)

ART.	L mm	P mm	H mm	KG	RAL	€
PERFOM14001	1023	555	2000	800	7035+7016	490,50
FAA1420C00108	1023	555	2000	800	7035	471,00
FAA1420C00104	1023	555	2000	800	5012	471,00

COMPOSTO DA:

- 1 armadio a porte battente
- 1 kit 4 piani fessurati



[CONFIGURE](#)

ART.	L mm	P mm	H mm	KG	RAL	€
PERFOM14004	1023	555	2000	800	7035+7016	697,50
PERFOM14005	1023	555	2000	800	7035	697,50
PERFOM14006	1023	555	2000	800	5012	697,50

COMPOSTO DA:

- 1 armadio a porte battente
- 1 kit 4 piani fessurati
- 3 cassetti ad estrazione semplice



[CONFIGURE](#)

ART.	L mm	P mm	H mm	KG	RAL	€
PERFOM14007	1023	555	2000	800	7035+7016	628,50
PERFOM14008	1023	555	2000	800	7035	628,50
PERFOM14009	1023	555	2000	800	5012	628,50

COMPOSTO DA:

- 1 armadio a porte battente fessurate in policarbonato
- 1 kit 4 piani fessurati



[CONFIGURE](#) 

BREVETTATO*

ART.	L mm	P mm	H mm	 KG	RAL	€
PERFOM14055	1023	555	2000	800	7035+7016	1.507,50

COMPOSTO DA:

- 1 armadio a porte a battente fessurate in policarbonato
- 2 kit 2 piani-pannelli forati
- 3 canalette elettriche per multiprese
- 1 magnetotermico differenziale
- 3 multiprese Schuko a 4 scomparti
- 6 multiprese Schuko a 2 scomparti
- 2 cavi di collegamento Wieland con spine in/out
- 1 cavo di collegamento Wieland Schuko/FR
- 4 lampade singole L=1000 mm

PERFOM 1023x555x2000

ARMADI A PORTE BATTENTE 54x27 EH



CONFIGURE



CONFIGURE



BREVETTATO*

ART.	L mm	P mm	H mm	KG	RAL	€
PERFOM14019	1023	555	2000	800	7035+7016	835,50
PERFOM14020	1023	555	2000	800	7035	835,50
PERFOM14021	1023	555	2000	800	5012	835,50

COMPOSTO DA:

- 1 armadio a porte battente fessurate
- 1 kit 2 piani fessurati
- 1 kit piano fessurato con 2 separatori e 6 taniche
- 1 kit vasca tenuta stagna completa di ganci (capacità 19 litri)

ART.	L mm	P mm	H mm	KG	RAL	€
PERFOM14022	1023	555	2000	800	7035+7016	1.581,30
PERFOM14023	1023	555	2000	800	7035	1.581,30
PERFOM14024	1023	555	2000	800	5012	1.581,30

COMPOSTO DA:

- 1 armadio a porte battente fessurate
- 1 kit 1 piano fessurato
- 3 kit piani fessurati con 2 separatori e 6 taniche
- 1 kit 1 vasca tenuta stagna completa di ganci (capacità 19 litri)
- 1 vasca stagna esterna raccolta liquidi (capacità 59 litri)



PERFOM 1023x555x2000

ARMADI A PORTE BATTENTE 54x27 EH



[CONFIGURE](#)

BREVETTATO*

ART.	L mm	P mm	H mm	KG	RAL	€
PERFOM14025	1023	555	2000	800	1004	558,60
PERFOM14026	1023	555	2000	800	7035+7016	558,60
PERFOM14027	1023	555	2000	800	7035	558,60
PERFOM14028	1023	555	2000	800	5012	558,60

COMPOSTO DA:

- 1 armadio a porte battente fessurate
- 1 kit 3 piani fessurati
- 1 vasca stagna esterna raccolta liquidi (capacità 59 litri)



vedi pag. 3



[CONFIGURE](#)

ART.	L mm	P mm	H mm	KG	RAL	€
PERFOM14029	1023	555	2000	800	1004	600,00
PERFOM14030	1023	555	2000	800	7035+7016	600,00
PERFOM14031	1023	555	2000	800	7035	600,00
PERFOM14032	1023	555	2000	800	5012	600,00

COMPOSTO DA:

- 1 armadio a porte battente fessurate
- 2 kit 2 vasche tenuta stagna complete di ganci (capacità 19 litri)



vedi pag. 3



[CONFIGURE](#)

ARMADIO DI SICUREZZA D.P.I. E ATTREZZATURE ANTINCENDIO

ART.	L mm	P mm	H mm	KG	RAL	€
PERFOM14033	1023	555	2000	800	3020	742,80

COMPOSTO DA:

- 1 armadio a porte battente fessurate safe crash
- 1 parete divisorio
- 1 kit tubo Ø 22 appendiabiti per piano forato
- 1 kit 1 piano-pannello forato
- 1 kit 3 piani fessurati



PERFOM 1023x555x2000

ARMADI A PORTE BATTENTE 54x27 EH



[CONFIGURE](#)

ART.	L mm	P mm	H mm	KG	RAL	€
PERFOM14034	1023	555	2000	800	7035+7016	1.126,50
PERFOM14035	1023	555	2000	800	7035	1.126,50
PERFOM14036	1023	555	2000	800	5012	1.126,50

BREVETTATO*

COMPOSTO DA:

- 1 armadio a porte battente fessurate
- 2 kit 2 piani-pannelli forati
- 2 canalette elettriche per multiprese
- 1 griglia ventole per armadi
- 2 ventole 230V senza griglia con spina Schuko
- 3 multiprese Schuko a 4 scomparti
- 4 multiprese Schuko a 2 scomparti
- 1 magnetotermico differenziale
- 1 cavo di collegamento Wieland con spine in/out
- 2 cavi di collegamento Wieland Schuko/FR
- 2 mensole grandi reversibili
- 1 kit porta rotolo con carta Ø 240/300 mm
- 1 confezione da 30 ganci Unipok

PERFOM 1023x555x2000

ARMADI A PORTE BATTENTE 54x27 EH



CONFIGURE



BREVETTATO*

ART.	L mm	P mm	H mm	KG	RAL	€
PERFOM14037	1023	555	2000	800	7035+7016	1.147,50
PERFOM14038	1023	555	2000	800	7035	1.147,50
PERFOM14039	1023	555	2000	800	5012	1.147,50

COMPOSTO DA:

- 1 armadio a porte a battente fessurate in policarbonato
- 2 kit 2 piani-pannelli forati
- 3 canalette elettriche per multiprese
- 1 magnetotermico differenziale
- 3 multiprese Schuko a 4 scomparti
- 6 multiprese Schuko a 2 scomparti
- 2 cavi di collegamento Wieland con spine in/out
- 1 cavo di collegamento Wieland Schuko/FR



CONFIGURE



BREVETTATO*

ART.	L mm	P mm	H mm	KG	RAL	€
PERFOM14040	1023	555	2000	800	7035+7016	1.029,60
PERFOM14041	1023	555	2000	800	7035	1.029,60
PERFOM14042	1023	555	2000	800	5012	1.029,60

COMPOSTO DA:

- 1 armadio a porte battente fessurate
- 2 kit 2 piani-pannelli forati
- 2 canalette elettriche per multiprese
- 1 magnetotermico differenziale
- 2 multiprese Schuko a 4 scomparti
- 4 multiprese Schuko a 2 scomparti
- 1 cavo di collegamento Wieland con spine in/out
- 1 cavo di collegamento Wieland Schuko/FR
- 1 kit porta rotolo con carta Ø 240/300 mm
- 2 mensole grandi reversibili
- 2 barre aggancio contenitori + 6 contenitori Picking Box mis. 2
- 2 confezioni da 30 ganci Unipok



CONFIGURE



BREVETTATO*

ART.	L mm	P mm	H mm	KG	RAL	€
PERFOM14043	1023	555	2000	800	7035+7016	775,50
PERFOM14044	1023	555	2000	800	7035	775,50
PERFOM14045	1023	555	2000	800	5012	775,50

COMPOSTO DA:

- 1 armadio a porte battente fessurate
- 2 kit 2 piani-pannelli forati
- 2 canalette elettriche per multiprese
- 2 multiprese Schuko a 4 scomparti
- 2 multiprese Schuko a 2 scomparti
- 1 cavo di collegamento Wieland Shuko/FR
- 1 cavo di collegamento Wieland con spine in/out

PERFOM 1023x555x2000

ARMADI A PORTE BATTENTE 54x27 EH



CONFIGURE

BREVETTATO*

ART.	L mm	P mm	H mm	KG	RAL	€
PERFOM14046	1023	555	2000	800	7035+7016	1.163,70
PERFOM14047	1023	555	2000	800	7035	1.163,70
PERFOM14048	1023	555	2000	800	5012	1.163,70

COMPOSTO DA:

- 1 armadio a porte battente
- 2 kit 2 piani-pannelli forati
- 2 coppie pannelli forati per porte a battente
- 3 cassetti ad estrazione semplice
- 2 mensole grandi reversibili
- 1 kit porta rotolo con carta Ø 240/300 mm
- 4 confezioni da 30 ganci Unipok
- 10 barre aggancio contenitori + 40 contenitori Picking Box mis. 1
- 4 barre aggancio contenitori + 12 contenitori Picking Box mis. 2



CONFIGURE

BREVETTATO*

ART.	L mm	P mm	H mm	KG	RAL	€
PERFOM14049	1023	555	2000	800	7035+7016	892,20
PERFOM14050	1023	555	2000	800	7035	892,20
PERFOM14051	1023	555	2000	800	5012	892,20

COMPOSTO DA:

- 1 armadio a porte battente
- 2 kit 2 piani-pannelli forati
- 3 cassetti ad estrazione semplice
- 4 barre aggancio contenitori + 12 contenitori Picking Box mis. 2
- 4 confezioni da 30 ganci Unipok



CONFIGURE

ART.	L mm	P mm	H mm	KG	RAL	€
PERFOM14052	1023	555	2000	800	7035+7016	1.050,00
PERFOM14053	1023	555	2000	800	7035	1.050,00
PERFOM14054	1023	555	2000	800	5012	1.050,00

COMPOSTO DA:

- 1 armadio a porte battente
- 1 kit 2 piani fessurati
- 3 cassetti ad estrazione semplice
- 4 cassetti ad estrazione telescopica

PERFOM 1023x555x2000

ARMADI A PORTE BATTENTE 54x27 EH



CONFIGURE



CONFIGURE



CONFIGURE

ART.	L mm	P mm	H mm	KG	RAL	€
PERFOM14010	1023	555	2000	800	7035+7016	544,80
PERFOM14011	1023	555	2000	800	7035	544,80
PERFOM14012	1023	555	2000	800	5012	544,80

COMPOSTO DA:

- 1 armadio a porte battente fessurate
- 1 parete divisorio
- 1 kit tubo Ø 22 appendiabiti per piano forato
- 1 kit 1 piano-pannello forato
- 1 kit 3 piani fessurati

ART.	L mm	P mm	H mm	KG	RAL	€
PERFOM14013	1023	555	2000	800	7035+7016	927,30
PERFOM14014	1023	555	2000	800	7035	927,30
PERFOM14015	1023	555	2000	800	5012	927,30

COMPOSTO DA:

- 1 armadio a porte battente
- 1 coppia pannelli forati per porte a battente
- 10 barre aggancio contenitori + 40 contenitori Picking Box mis. 1
- 5 contenitori Picking Box mis. 2
- 20 contenitori Picking Box mis. 3A2
- 6 contenitori Picking Box mis. 4
- 6 contenitori Picking Box mis. 4A2
- 1 kit 3 piani fessurati profondità 345 mm
- 1 kit 2 piani fessurati profondità 345 mm
- 1 kit 3 piani fessurati profondità 500 mm

ART.	L mm	P mm	H mm	KG	RAL	€
PERFOM14016	1023	555	2000	800	7035+7016	1.067,10
PERFOM14017	1023	555	2000	800	7035	1.067,10
PERFOM14018	1023	555	2000	800	5012	1.067,10

COMPOSTO DA:

- 1 armadio a porte battente
- 1 coppia pannelli forati per porte a battente
- 1 kit 1 piano-pannello forato
- 1 kit 1 piano fessurato profondità 500 mm
- 2 kit 2 piani fessurati profondità 345 mm
- 3 cassette ad estrazione semplice
- 10 barre aggancio contenitori + 40 contenitori Picking Box mis. 1
- 6 barre aggancio contenitori + 18 contenitori Picking Box mis. 2
- 20 Picking Box mis. 3A2
- 5 Picking Box mis. 2

PERFOM COMPONENTI

ARMADI VUOTI



CONFIGURE



ARMADIO A PORTE BATTENTE 64x27 EH

ART.	L mm	P mm	H mm	KG	RAL	€
FAA1520C000PD	1193	555	1000	800	7035+7016	402,00
FAA1520C00008	1193	555	1000	800	7035	402,00
FAA1520C00004	1193	555	1000	800	5012	402,00

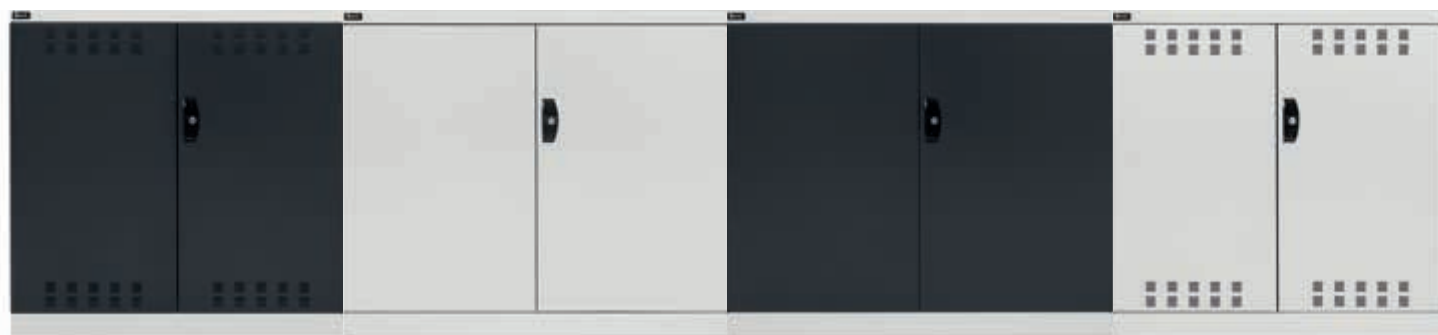

CONFIGURE



ARMADIO A PORTE BATTENTE 64x27 EH

ART.	L mm	P mm	H mm	KG	RAL	€
FAA1720C000PD	1193	555	2000	800	7035+7016	465,00
FAA1720C00008	1193	555	2000	800	7035	465,00
FAA1720C00004	1193	555	2000	800	5012	465,00

PERFOM COMPONENTI

ARMADI VUOTI



CONFIGURE



ARMADIO A PORTE BATTENTE 24x27 EH

ART.	L mm	P mm	H mm	KG	RAL	€
FAA1120C000PD	512	555	1000	800	7035+7016	231,00
FAA1120C00008	512	555	1000	800	7035	231,00
FAA1120C00004	512	555	1000	800	5012	231,00



CONFIGURE



ARMADIO A PORTE BATTENTE FESSURATE 24x27 EH

ART.	L mm	P mm	H mm	KG	RAL	€
FAA1130C00030	512	555	1000	800	1004	231,00
FAA1130C000PD	512	555	1000	800	7035+7016	231,00
FAA1130C00008	512	555	1000	800	7035	231,00
FAA1130C00004	512	555	1000	800	5012	231,00



CONFIGURE



ARMADIO A PORTE BATTENTE 54x27 EH

ART.	L mm	P mm	H mm	KG	RAL	€
FAA1220C000PD	1023	555	1000	800	7035+7016	336,00
FAA1220C00008	1023	555	1000	800	7035	336,00
FAA1220C00004	1023	555	1000	800	5012	336,00



CONFIGURE



ARMADIO A PORTE BATTENTE FESSURATE 54x27 EH

ART.	L mm	P mm	H mm	KG	RAL	€
FAA1230C00030	1023	555	1000	800	1004	336,00
FAA1230C0002Y	1023	555	1000	800	3020	336,00
FAA1230C000PD	1023	555	1000	800	7035+7016	336,00
FAA1230C00008	1023	555	1000	800	7035	336,00
FAA1230C00004	1023	555	1000	800	5012	336,00



RAL 1004



RAL 3020



RAL 5012



RAL 7035



RAL 7035+RAL 7016



PORTATA KG

PERFOM COMPONENTI

ARMADI VUOTI



[CONFIGURE](#)



ARMADI A PORTE BATTENTE 54x27 EH

ART.	L mm	P mm	H mm	KG	RAL	€
FAA1420C000PD	1023	555	2000	800	7035+7016	402,00
FAA1420C00008	1023	555	2000	800	7035	402,00
FAA1420C00004	1023	555	2000	800	5012	402,00



[CONFIGURE](#)



ARMADI A PORTE BATTENTE FESSURATE 54x27 EH

ART.	L mm	P mm	H mm	KG	RAL	€
FAA1430C00030	1023	555	2000	800	1004	402,00
FAA1430C000PD	1023	555	2000	800	7035+7016	402,00
FAA1430C00008	1023	555	2000	800	7035	402,00
FAA1430C00004	1023	555	2000	800	5012	402,00



PERFOM COMPONENTI

ARMADI VUOTI



ARMADI A PORTE BATTENTE FESSURATE IN POLICARBONATO 54x27 EH

ART.	L mm	P mm	H mm	KG	RAL	€
FAA1440C000PD	1023	555	2000	800	7035+7016	540,00
FAA1440C00008	1023	555	2000	800	7035	540,00
FAA1440C00004	1023	555	2000	800	5012	540,00



ARMADI A PORTE BATTENTE FESSURATE SAFE CRASH 54x27 EH

ART.	L mm	P mm	H mm	KG	RAL	€
FAA1440C0SC2Y	1023	555	2000	800	3020	600,00



PERFOM COMPONENTI

TOP A 3 BORDI RIVESTITO IN PVC

ART.	L mm	P mm	H mm	colore	€
FAC9911290007	512	555	23	nero	51,00
FAC9912290007	1023	555	23	nero	63,00
FAC9915290007	1193	555	23	nero	64,50



KIT PIANI FESSURATI

ART.	L mm	P mm	H mm	KG	n. piani	colore	€
FAC9911010099	484	500	35	100	1	zincato	13,50
FAC9911020099	484	500	35	100	2	zincato	25,50
FAC9911030099	484	500	35	100	3	zincato	37,50
FAC9912010099	995	500	35	100	1	zincato	22,80
FAC9912020099	995	500	35	100	2	zincato	45,00
FAC9912030099	995	500	35	100	3	zincato	66,60
FAC9912040099	995	500	35	100	4	zincato	88,50
FAC9915010099	1165	500	35	100	1	zincato	28,50
FAC9915020099	1165	500	35	100	2	zincato	55,50
FAC9915030099	1165	500	35	100	3	zincato	84,00



KIT PIANI FESSURATI

ART.	L mm	P mm	H mm	KG	n. piani	colore	€
FAC9912050099	995	345	35	100	2	zincato	45,00
FAC9912060099	995	345	35	100	3	zincato	66,60



MIS. 2



MIS. 3A2

CONTENITORI VEDI
PAG. 160-161



BARRE AGGANCIO CONTENITORI CON 4 CONTENITORI PICKING BOX MIS. 1

ART.	L mm	P mm	H mm	colore contenitori	€
FBLIT011000 (IDEAONE05221)	445	168	85	grigio	9,30
FBLIT029000	445	168	85	blu	9,30



PIANO-PANNELLO FORATO

APPLICABILE IN

3 DIVERSE POSIZIONI:

1. PANNELLO FORATO VERTICALE
2. PIANO ORIZZONTALE
3. MENSOLA FORATA A 4 BORDI



1.

KIT PIANI-PANNELLI FORATI

ART.	L mm	P mm	H mm	KG	n. piani-pannelli	RAL	€
FAC9912070039	995	500	30	100	1	7016	54,00
FAC9912070008	995	500	30	100	1	7035	54,00
FAC9912070004	995	500	30	100	1	5012	54,00
FAC9912080008	995	500	30	100	2	7035	102,00
FAC9912080004	995	500	30	100	2	5012	102,00



2.

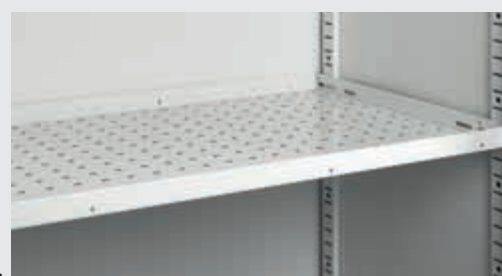

3.

IRON TEAM + UNIPOK

vedi pag. 60-71



CASSETTI AD ESTRAZIONE SEMPLICE 24x27 EH

ART.	L mm	P mm	H mm	frontale cassetto	ESTRAZIONE	KG	RAL	€
FAC9911180008	398	449	85	100	87%	50	7035	57,00
FAC9911180004	398	449	85	100	87%	50	5012	57,00

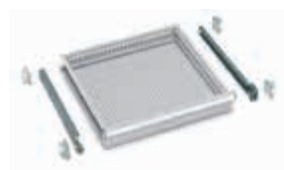

CASSETTI AD ESTRAZIONE SEMPLICE 54x27 EH

ART.	L mm	P mm	H mm	frontale cassetto	ESTRAZIONE	KG	RAL	€
FAC9912180008	908	449	85	100	87%	50	7035	69,00
FAC9912180004	908	449	85	100	87%	50	5012	69,00



CASSETTI AD ESTRAZIONE TELESCOPICA 54x27 EH

ART.	L mm	P mm	H mm	frontale cassetto	ESTRAZIONE	KG	RAL	€
FAC9912190008	908	449	85	100	100%	100	7035	93,00
FAC9912190004	908	449	85	100	100%	100	5012	93,00
FAC9912210008	908	449	135	150	100%	100	7035	99,00
FAC9912210004	908	449	135	150	100%	100	5012	99,00



CASSETTI AD ESTRAZIONE TELESCOPICA 64x27 EH

ART.	L mm	P mm	H mm	frontale cassetto	ESTRAZIONE	KG	RAL	€
FAC9915190008	1078	449	85	100	100%	100	7035	120,00
FAC9915190004	1078	449	85	100	100%	100	5012	120,00

PERFOM COMPONENTI



COPPIA PANNELLI FORATI PER PORTE A BATTENTE

ART.	L mm	P mm	H mm	RAL	€
FAC9912250039	381	20	824	7016	49,50



SI POSSONO POSIZIONARE FINO AD UN MASSIMO DI 2 COPPIE PANNELLI PER PORTA

BREVETTATO*



CANALETTA ELETTRICA PER MULTIPRESE PER ARMADIO L=1023

ART.	L mm	P mm	H mm	RAL	€
FAC9912220039	1008	70	139	7016	21,00



magneto-termico multipresa 4 posti multipresa 2 posti multipresa 2 posti USB ricarica



applicazione canaletta elettrica sulla parte **superiore** del piano-pannello forato



applicazione canaletta elettrica sulla parte **inferiore** del piano-pannello forato



canaletta elettrica integrabile con **piano-pannello forato** in posizione verticale



SUPPORTO LATERALE PER MULTIPRESA

ART.	L mm	P mm	H mm	RAL	€
FAC9912240039	463	10	77	7016	12,00



multipresa 4 posti



Esempio di applicazione con:
1 supporto art. FAC9912240039
1 multipresa art. FBLET005007
1 cavo di collegamento art. FBLET016007



GRIGLIA VENTOLE PER ARMADIO L=1023

ART.	L mm	P mm	H mm	RAL	€
FAC9912230039	994	123	136	7016	25,50



Esempio di applicazione con:
 1 griglia art. FAC9912230039
 2 ventole art. FAS32200100
 1 multi presa art. FBLET005007
 1 cavo di collegamento art. FBLET016007



applicazione griglia nella parte superiore dell'armadio **senza** l'ausilio del piano-pannello forato



applicazione griglia nella parte **superiore** dell'armadio **con** l'ausilio del piano-pannello forato



applicazione griglia nella parte **inferiore** dell'armadio con l'ausilio del piano-pannello forato

VENTOLA 230V SENZA GRIGLIA CON SPINA SCHUKO

ART.	colore	€
FAS32200100 (IDEAONE03066)	nero	28,50



IRON TEAM ELECTRIC

vedi pag. 68-70



[FBLET012007](#)
(IDEAONE05178)



[FBLET004007](#)
(IDEAONE05165)



[FBLET005007](#)
(IDEAONE05166)



[FBLET016007](#)
(IDEAONE05179)



[FBLET014007](#)
(IDEAONE05174)



[FBLET020007](#)



[FBL99400008](#)

APPLICAZIONE DELLA LAMPADA SOTTO IL PIANO FORATO



PERFOM COMPONENTI



ZOCCOLI PER TRANSPALLET COMPLETO DI CHIUSURA

ART.	L mm	P mm	H mm	KG	RAL	€
FAC9912170039	1018	548	100	800	7016	138,00
FAC9915170039	1188	548	100	800	7016	159,00



BREVETTATO*

VASCA STAGNA ESTERNA RACCOLTA LIQUIDI

ART.	L mm	P mm	H mm	KG	RAL	L	€
FAC9912130039	1048	600	100	800	7016	59	90,00



KIT VASCHE STAGNE INTERNE RACCOLTA LIQUIDI

ART.	L mm	P mm	H mm	KG	n. vasche	L	colore	€
FAC9911090099	484	500	42	50	1	9	zincato	45,00
FAC9911100099	484	500	42	50	2	9	zincato	90,00
FAC9912090099	995	500	42	50	1	19	zincato	49,50
FAC9912100099	995	500	42	50	2	19	zincato	99,00



KIT PIANO FESSURATO CON 2 SEPARATORI E 6 TANICHE 10 L. CON RUBINETTO A SFERA

ART.	L mm	P mm	H mm	KG	colore	€
FAC9912280099	995	495	307	60	zincato	339,00





PARETE DIVISORIO

ART.	rif.	L mm	P mm	H mm	RAL	€
FAC9912260039	A	27	500	1615	7016	46,50

KIT TUBO Ø 22 APPENDIABILI

ART.	rif.	L mm	P mm	H mm	KG	colore	€
FAC9912270099	B	460	23	56	15	zincato	4,80



PIANO-PANNELLO FORATO

ART.	rif.	L mm	P mm	H mm	KG	RAL	€
FAC9912070039	C	995	500	30	100	7016	54,00

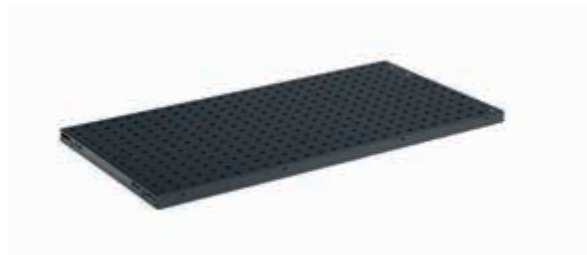

KIT PIANI FESSURATI

ART.	rif.	L mm	P mm	H mm	KG	n. piani	colore	€
FAC9911030099	D	484	500	35	100	3	zincato	37,50



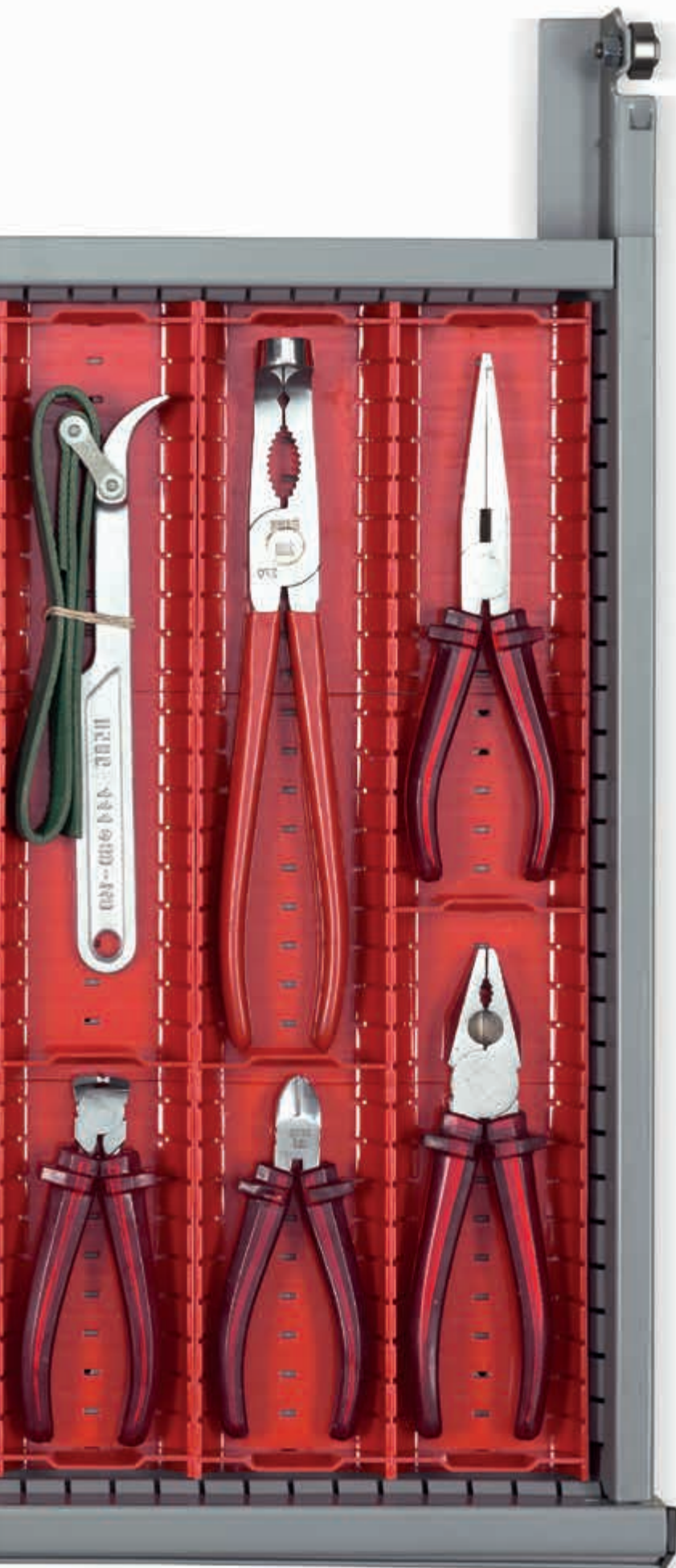

MATERIALE DI SEPARAZIONE 24x27 EH ARMADIO L=512 mm

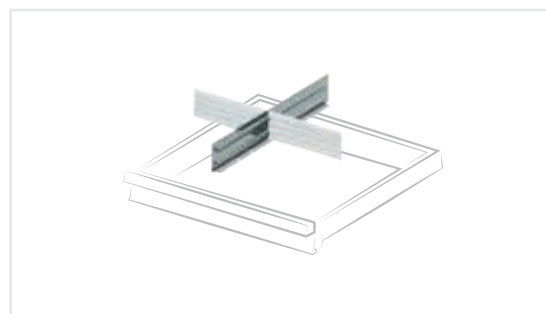

ART.	per altezza frontale mm	€
FFH00500100	100	4,80

Composto da 1 divisorio longitudinale fessurato 455 mm, 2 divisori trasversali 200 mm

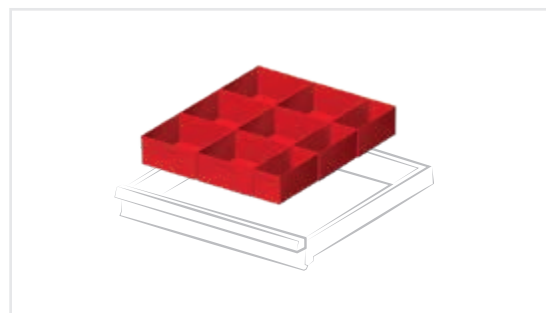

ART.	per altezza frontale mm	€
FFH00500800	100	13,80

Composto da 3 cassette divisorio 150x75 mm, 6 cassette divisorio 150x150 mm

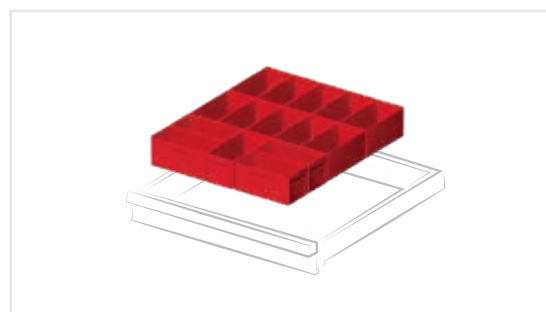

ART.	per altezza frontale mm	€
FFH00500900	100	16,50

Composto da 15 cassette divisorio 150x75 mm

MATERIALE DI SEPARAZIONE **54x27** EH
ARMADIO L=1023 mm

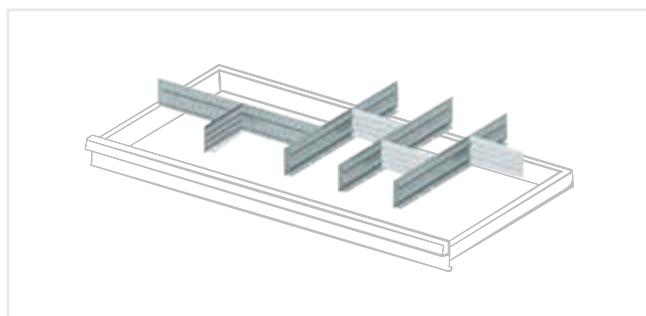

ART.	per altezza frontale mm	€
FFH02000100	100	14,40

Composto da 4 divisori longitudinali fessurati 455 mm, 4 divisori trasversali 149 mm

MATERIALE DI SEPARAZIONE **64x27** EH
ARMADIO L=1193 mm

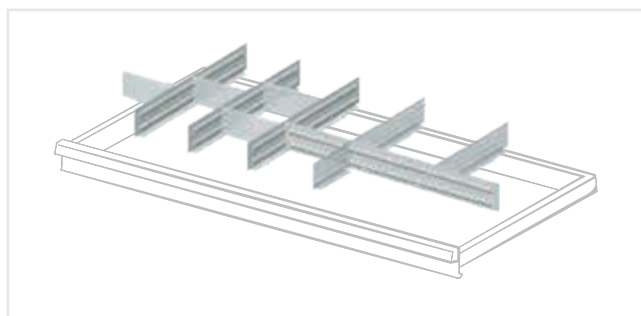

ART.	per altezza frontale mm	€
FFH02500300	100	19,50

Composto da 3 divisori longitudinali fessurati 455 mm, 1 divisorio longitudinale fessurato 600 mm, 3 divisori trasversali 149 mm, 2 divisori trasversali 166 mm, 2 divisori trasversali 302 mm

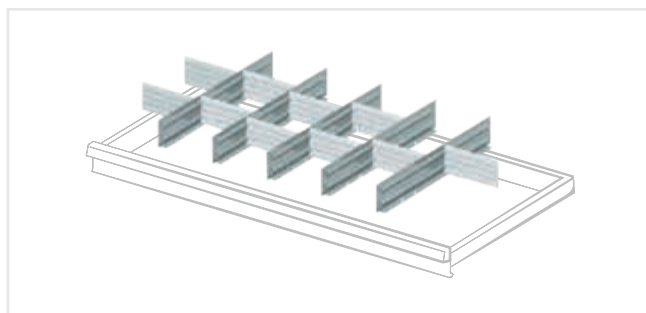

ART.	per altezza frontale mm	€
FFH02000200	100	21,60

Composto da 5 divisori longitudinali fessurati 455 mm, 10 divisori trasversali 149 mm

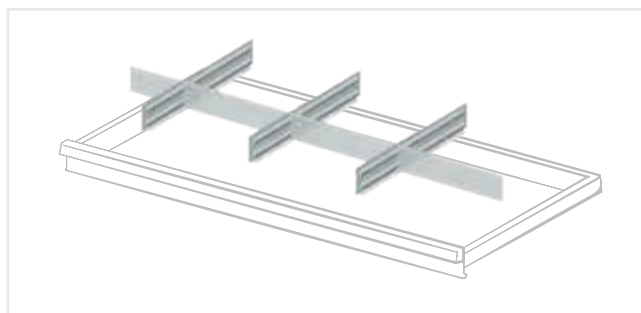

ART.	per altezza frontale mm	€
FFH02500400	100	14,10

Composto da 3 divisori longitudinali fessurati 455 mm, 1 divisorio trasversale 166 mm, 3 divisori trasversali 302 mm

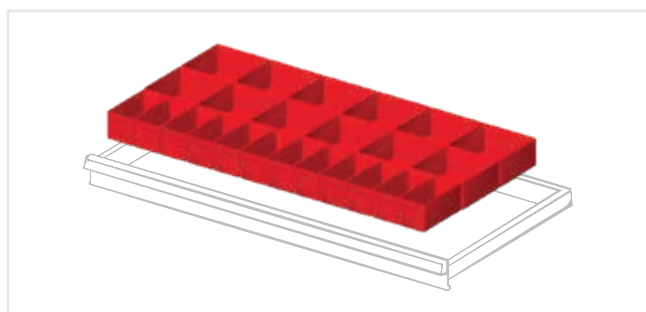

ART.	per altezza frontale mm	€
FFH02000600	100	34,50

Composto da 12 cassette divisorio 150x75 mm, 12 cassette divisorio 150x150 mm

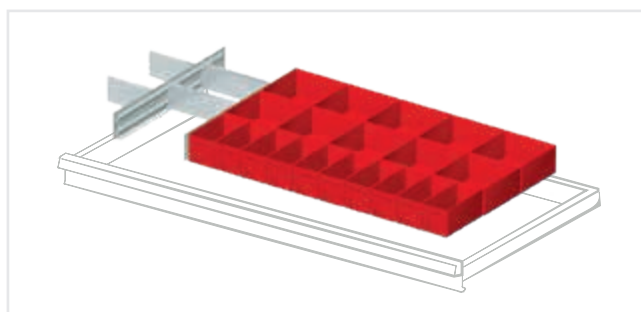

ART.	per altezza frontale mm	€
FFH02500600	100	38,10

Composto da 2 divisori longitudinali fessurati 455 mm, 2 divisori trasversali 132 mm, 2 divisori trasversali 200 mm, 10 cassette divisorio 150x75 mm, 10 cassette divisorio 150x150 mm

PERFOM

ARMADI CON PORTE SCORREVOLI



PORTATA PER
CAMPATA 800 KG



GARANZIA
PORTE

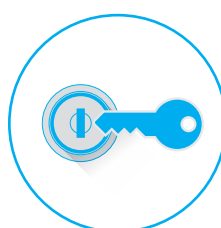

CHIUSURA
A CHIAVE

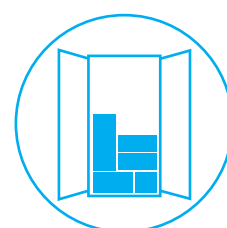

ARMADIO MONTATO
+ ACCESSORI CONFEZIONATI
ALL'INTERNO DELL'ARMADIO



armadio					piani			RAL	€
ART.	L mm	P mm	H mm	KG	n.	profondità mm	KG		
FAB5100C00208	1500	450	1000	600	1	370	100	7035	633,00
FAB5100C00204	1500	450	1000	600	1	370	100	5012	633,00





armadio					piani			RAL	€
ART.	L mm	P mm	H mm	KG	n.	profondità mm	KG		
FAB5300C00208	1500	450	2000	800	4	370	100	7035	861,00
FAB5300C00204	1500	450	2000	800	4	370	100	5012	861,00





armadio					piani			RAL	€
ART.	L mm	P mm	H mm	KG	n.	profondità mm	KG		
FAB7300C00108	2046	450	2000	800+800	8	370	100	7035	1.227,00
FAB7300C00104	2046	450	2000	800+800	8	370	100	5012	1.227,00





armadio					piani			RAL	€
ART.	L mm	P mm	H mm	 KG	n.	profondità mm	 KG		
FAB6100C00208	1500	600	1000	600	1	500	100	7035	678,00
FAB6100C00204	1500	600	1000	600	1	500	100	5012	678,00







armadio					piani			RAL	€
ART.	L mm	P mm	H mm	 KG	n.	profondità mm	 KG		
FAB6300C00208	1500	600	2000	800	4	500	100	7035	921,00
FAB6300C00204	1500	600	2000	800	4	500	100	5012	921,00



armadio					piani			RAL	€
ART.	L mm	P mm	H mm		n.	profondità mm			
FAB8300C00108	2046	600	2000	800+800	8	500	100	7035	1.233,00
FAB8300C00104	2046	600	2000	800+800	8	500	100	5012	1.233,00



armadio					piani			cassetti			RAL	€	
ART.	L mm	P mm	H mm		n.	profondità mm		n.	H 100 mm				
FAB8300C00908	2046	600	2000	800+800	8	500	100	6	6	87%	50	7035	1.635,00
FAB8300C00904	2046	600	2000	800+800	8	500	100	6	6	87%	50	5012	1.635,00

PERFOM

ARMADI SPOGLIATOIO



**PIEDINI IN
POLIPROPILENE
FACILE PULIZIA**

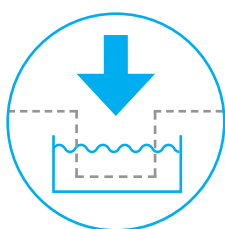

**VERNICIATURA
IN ELETTROFORESI**



**VERSIONE CON VANO
PORTA CASCO**

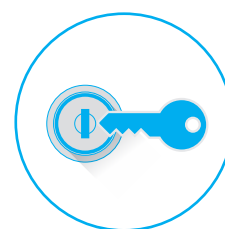

**CHIUSURA
A CHIAVE**



ART.	L mm	P mm	H mm	RAL	€
PERFOMANO1	1195	500	1950	7035	450,00

COMPOSTO DA:

- 1 armadio spogliatoio a 4 scomparti
- 1 coppia piedini in polipropilene



ART.	L mm	P mm	H mm	RAL	€
PERFOMANO2	1195	500	1950	7035	450,00

COMPOSTO DA:

- 1 armadio spogliatoio a 3 scomparti
- 1 coppia piedini in polipropilene



ART.	L mm	P mm	H mm	RAL	€
PERFOMANO3	1195	500	2141	7035	517,50

COMPOSTO DA:

- 1 armadio spogliatoio a 4 scomparti
- 1 tetto inclinato aggiuntivo
- 1 coppia piedini in polipropilene



ART.	L mm	P mm	H mm	RAL	€
PERFOMANO4	1195	500	2141	7035	517,50

COMPOSTO DA:

- 1 armadio spogliatoio a 3 scomparti
- 1 tetto inclinato aggiuntivo
- 1 coppia piedini in polipropilene

ARMADI SPOGLIATOIO



[CONFIGURE](#)

ART.	L mm	P mm	H mm	scomparti	RAL	€
FAN1302C00108 (IDEAONE04045)	610	500	1750	2	7035	264,00

Con chiusura a cilindro e vano porta casco

TETTO INCLINATO AGGIUNTIVO

ART.	L mm	P mm	H mm	RAL	€
FAN51400008 (IDEAONE04037)	607	502	191	7035	46,50



[CONFIGURE](#)

ART.	L mm	P mm	H mm	scomparti	RAL	€
FAN1303C00108 (IDEAONE04046)	900	500	1750	3	7035	339,00

Con chiusura a cilindro e vano porta casco

TETTO INCLINATO AGGIUNTIVO

ART.	L mm	P mm	H mm	RAL	€
FAN51600008 (IDEAONE04039)	899	502	191	7035	58,50



[CONFIGURE](#)

ART.	L mm	P mm	H mm	scomparti	RAL	€
FAN1502C03108 (IDEAONE04043)	805	500	1750	2	7035	321,00

Con divisorio sporco/pulito zincato, chiusura a cilindro e vano porta casco

TETTO INCLINATO AGGIUNTIVO

ART.	L mm	P mm	H mm	RAL	€
FAN51500008 (IDEAONE04038)	801	502	191	7035	51,00



[CONFIGURE](#)

ART.	L mm	P mm	H mm	scomparti	RAL	€
FAN1503C03108 (IDEAONE04044)	1195	500	1750	3	7035	438,00

Con divisorio sporco/pulito zincato, chiusura a cilindro e vano porta casco

TETTO INCLINATO AGGIUNTIVO

ART.	L mm	P mm	H mm	RAL	€
FAN51800008 (IDEAONE04040)	1191	502	191	7035	67,50



ART.	L mm	P mm	H mm	scomparti	RAL	€
FAN1304C00108 (IDEAONE04047)	1195	500	1750	4	7035	438,00

Con chiusura a cilindro e vano porta casco

TETTO INCLINATO AGGIUNTIVO

ART.	L mm	P mm	H mm	RAL	€
FAN51800008 (IDEAONE04040)	1191	502	191	7035	67,50

TETTO inclinato aggiuntivo



FAN51400008 - FAN51600008 -
FAN51500008 - FAN51800008



KIT PIEDINI

ART.	L mm	P mm	H mm	colore	€
FRR23100001 (IDEAONE04048)	135	500	200	grigio	12,00

PANCA SPOGLIATOIO SINGOLA



ART.	L mm	P mm	H mm	RAL	€
FAN95400001 (IDEAONE04033)	1000	360	385	7000	72,00



ART.	L mm	P mm	H mm	RAL	€
FAN95500001 (IDEAONE04032)	1495	360	385	7000	87,00



ART.	L mm	P mm	H mm	RAL	€
FAN95600001 (IDEAONE04031)	2000	360	385	7000	123,00

NC

PORTA UTENSILI



**CASSETTI AD
ESTRAZIONE TOTALE**



**ARMADIO
PORTATA 800 KG**

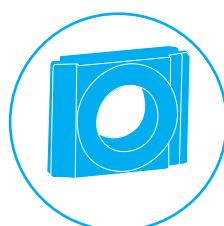

**VASTA GAMMA DI
BOCCOLE**



CONFIGURABILE

NC PORTA UTENSILI

ARMADI PORTE A BATTENTE - CARRELLI



[CONFIGURE](#)



[CONFIGURE](#)

ART.	L mm	P mm	H mm	KG	telai	cassetti	boccole	tipo boccole	RAL	€
PERFOMNC01	1023	555	2000	800	4	-	168	ISO 40	7035	1.164,00
PERFOMNC02	1023	555	2000	800	4	-	168	ISO 40	5012	1.164,00
PERFOMNC03	1023	555	2000	800	4	-	100	ISO 50	7035	990,00
PERFOMNC04	1023	555	2000	800	4	-	100	ISO 50	5012	990,00
PERFOMNC05	1023	555	2000	800	4	-	120	HSK A63-B80	7035	1.056,00
PERFOMNC06	1023	555	2000	800	4	-	120	HSK A63-B80	5012	1.056,00
PERFOMNC07	1023	555	2000	800	2	2	154	ISO 40	7035	1.266,00
PERFOMNC08	1023	555	2000	800	2	2	154	ISO 40	5012	1.266,00
PERFOMNC09	1023	555	2000	800	2	2	90	ISO 50	7035	1.101,00
PERFOMNC10	1023	555	2000	800	2	2	90	ISO 50	5012	1.101,00
PERFOMNC11	1023	555	2000	800	2	2	120	HSK A63-B80	7035	1.200,00
PERFOMNC12	1023	555	2000	800	2	2	120	HSK A63-B80	5012	1.200,00



[CONFIGURE](#)

ART.	L mm	P mm	H mm	KG	boccole	tipo boccole	RAL	€
COMBINC01	1064	512	890	500	35	ISO 40	7035+7000	507,00
COMBINC02	1064	512	890	500	35	ISO 40	5012+7000	507,00
COMBINC03	1064	512	890	500	25	ISO 50	7035+7000	484,50
COMBINC04	1064	512	890	500	25	ISO 50	5012+7000	484,50
COMBINC05	1064	512	890	500	25	HSK A63-B80	7035+7000	484,50
COMBINC06	1064	512	890	500	25	HSK A63-B80	5012+7000	484,50

RAL 5012
 RAL 7035





 RAL 5012+RAL 7000

 RAL 7035+RAL 7000
 KG PORTATA KG



TELAIO PORTA BOCCOLE DA BANCO

ART.	L mm	P mm	H mm	RAL	€
FNC20100008 (IDEAONE16027)	565	450	350	7035	81,00
FNC20100004 (IDEAONE16001)	565	450	350	5012	81,00

boccola								€ cadauno
ART.	tipo	multiplo d'ordine	q.tà max. 	q.tà max. 	q.tà max. 	q.tà max. 	q.tà max. 	
FNC95100003	ISO 30	7	7	21	42	35	21	3,00
FNC95300003 (IDEAONE16035)	ISO 40	7	7	21	42	35	21	3,00
FNC95400003	ISO 45	6	6	18	30	30	18	3,30
FNC95500003 (IDEAONE16036)	ISO 50	5	5	15	25	20	15	3,30
FNC95600003	VDI 30	7	7	21	42	35	21	3,30
FNC95700003	VDI 40	5	5	15	30	30	15	3,30
FNC95800003	VDI 50	5	5	15	30	30	15	4,20
FNC95900003	VDI 60	5	5	15	25	20	15	7,20
FNC97200003	CONO MORSE 2	7	7	21	42	35	21	3,30
FNC97300003	CONO MORSE 3	7	7	21	42	35	21	3,30
FNC97400003	CONO MORSE 4	7	7	21	42	35	21	3,30
FNC97500003	CONO MORSE 5	5	5	15	30	30	15	3,30
FNC92700003	CAPTO C3	7	7	21	42	35	21	4,20
FNC92750003	CAPTO C4	5	5	15	30	30	15	4,20
FNC92800003	CAPTO C5	5	5	15	30	30	15	4,20
FNC92850003	CAPTO C6	5	5	15	30	30	15	4,20
FNC92900003	CAPTO C8	5	5	15	20	20	15	4,20
FNC92100003	HSK A32-B40	7	7	21	42	35	21	3,30
FNC92200003	HSK A40-B50	7	7	21	42	35	21	3,30
FNC92300003	HSK A50-B63	5	5	15	30	30	15	3,30
FNC92400003 (IDEAONE16034)	HSK A63-B80	5	5	15	30	30	15	3,30
FNC92500003	HSK A80-B100	5	5	15	20	20	15	4,20
FNC92600003	HSK A100-B125	5	5	15	20	20	15	4,20
FNC96400003	2"	6	6	18	30	30	18	4,20
FNC96500003	2 ¹ / ₄ "	5	5	15	25	20	15	7,20

NC COMPONENTI

ARMADI A PORTE BATTENTE 54x27 EH

ART.	L mm	P mm	H mm	KG	RAL	€
FAA1420C000PD	1023	555	2000	800	7035+7016	402,00
FAA1420C00008	1023	555	2000	800	7035	402,00
FAA1420C00004	1023	555	2000	800	5012	402,00



CASSETTO A ESTRAZIONE TELESCOPICA 54x27 EH

ART.	L mm	P mm	H mm	frontale cassetto	KG	RAL	€
FAC9912190008	908	449	85	100	100%	7035	93,00
FAC9912190004	908	449	85	100	100%	5012	93,00
FAC9912210008	908	449	135	150	100%	7035	99,00
FAC9912210004	908	449	135	150	100%	5012	99,00



TELAIO PORTA BOCCOLE A 3 FILE PER CASSETTI COMPLETO DI SUPPORTI

ART.	L mm	P mm	H mm	RAL	€
FNC5140S101 (IDEAONE16032)	890	444	69	7000	87,00

CONFEZIONE 2 PZ. - BOCCOLE ESCLUSE

x2

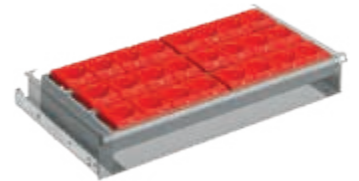

x2



TELAIO PORTA BOCCOLE A 3 FILE INCLINABILE

ART.	L mm	P mm	H mm	KG	RAL	€
FNC5160S101 (IDEAONE16031)	965	495	69	150	7000	129,00

CONFEZIONE 2 PZ.



CARRELLO PORTA UTENSILI CON RUOTE SENZA BOCCOLE

ART.	carrello					ruote							RAL	€
	L mm	P mm	H mm	KG	telai	Ø mm	KG	H mm	materiale	ruota girevole	ruota girevole con freno	ruota fissa		
FCNF1001056 (IDEAONE16028)	1064	512	890	500	3	125	180	160	nylon	1	1	2	7035+7000	402,00
FCNF1001051 (IDEAONE16004)	1064	512	890	500	3	125	180	160	nylon	1	1	2	5012+7000	402,00

ruota girevole
 ruota girevole con freno
 ruota fissa



ECOLOGIA

Le vasche di raccolta prevengono gli sversamenti accidentali di sostanze pericolose ed inquinanti, in ottemperanza al D.Lgs. N.152/2006 e D.Lgs. N.81/2008.

Attenzione! Si ricorda di non stoccare nella stessa vasca sostanze chimiche che a contatto tra loro possano reagire e di verificare la compatibilità delle sostanze pericolose stoccate con il materiale di fabbricazione di vasca e griglia.

La capacità dei contenitori stoccabili sopra ogni vasca e le informazioni fornite, non esaustive né vincolanti, sono valide per il territorio italiano. Per altri Paesi, attenersi alle disposizioni specifiche vigenti nel Paese di utilizzo e contattare le autorità locali competenti per maggiori informazioni.



VASCHE DI RACCOLTA + RIPIANI E VASCHE PERFORM IN ACCIAIO

Idonee a liquidi infiammabili delle categorie GHS 1 – 3 e liquidi inquinanti per le acque delle categorie GHS 1 – 4.

Non sono ammesse sostanze corrosive.



VASCHE DI RACCOLTA IN PE

Idonee a liquidi inquinanti per le acque delle categorie GHS 1 – 4. Non sono ammesse sostanze infiammabili.

ECOLOGIA

BENNE PORTA TRUCIOLI COMPLETAMENTE RIBALTABILI



A



B



C

BENNA RIBALTABILE CON RUOTE PREDISPOSTA PER GRIGLIA E RUBINETTO

ART.	benna					ruote						RAL	€
	L mm	P mm	H mm	L	KG	Ø mm	KG	H mm	materiale				
FAXLT0300000004 (IDEAONE14001)	820	1370	870	285	600	125	275	155	nylon	2	2	5012	720,00
FAXLT0500000004 (IDEAONE14002)	920	1370	900	490	1000	160	350	200	nylon	2	2	5012	903,00
FAXLT0400000004 (IDEAONE14003)	820	1370	855	420	800	125	275	155	nylon	2	2	5012	777,00

ruota girevole con freno

ruota fissa



RUOTE FORNITE SMONTATE



KIT RUBINETTO + GRIGLIA

ART.	L mm	P mm	H mm	adatto per art.	RAL	€
FAXLT0300KTG004 (IDEAONE14007)	310	730	68	FAXLT0300000004 FAXLT0400000004	5012	115,50
FAXLT0500KTG004 (IDEAONE14008)	306	830	68	FAXLT0500000004	5012	120,00



VASCA DI SICUREZZA IN LAMIERA CON GRIGLIA (CISTERNA ESCLUSA)

ART.	vasca			per cisterna		RAL	€
	L mm	P mm	H mm	n.	L		
FAXVDRHV0000054 (IDEAONE17005)	1350	1504	630	1	1000	5012+zincato	690,00

ECOLOGIA

PORTA FUSTI - VASCHE IN PLASTICA

STRUTTURA PORTA FUSTI CON VASCA DI RACCOLTA

ART.	RAL	€
EC01301	5012+ zincato	852,00

COMPOSTO DA:

- 1 vasca di raccolta senza pareti per 4 fusti
- 1 supporto sovrapponibile per 2 fusti da 200 litri
- 1 supporto sovrapponibile per 3 fusti da 60 litri



vedi pag. 3

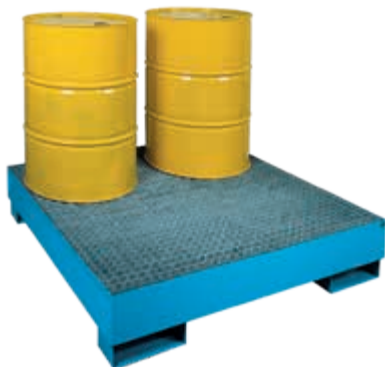

VASCA DI RACCOLTA SENZA PARETI

ART.	vasca			per fusti		RAL	€
	L mm	P mm	H mm	n.	L		
FML08100054 (IDEAONE17001)	960	960	332	1	200	5012+ zincato	294,00
FML08200054 (IDEAONE17002)	1355	875	332	2	250	5012+ zincato	333,00
FML08300054 (IDEAONE17003)	1355	1255	290	4	300	5012+ zincato	414,00



vedi pag. 3



PORTA FUSTI IMPILABILE

ART.	porta fusti			per fusti		RAL	€
	L mm	P mm	H mm	n.	L		
FML08501204 (IDEAONE17022)	1410	646	756	2	200	5012	213,00



PORTA FUSTI IMPILABILE

ART.	porta fusti			per fusti		RAL	€
	L mm	P mm	H mm	n.	L		
FML08501304 (IDEAONE17023)	1420	670	760	3	60	5012	225,00



PORTA FUSTI NON IMPILABILE

ART.	porta fusti			per fusti		RAL	€
	L mm	P mm	H mm	n.	L		
FML08600104 (IDEAONE17011)	876	604	386	1	200	5012	117,00



PORTA FUSTI NON IMPILABILE

ART.	porta fusti			per fusti		RAL	€
	L mm	P mm	H mm	n.	L		
FML08600204 (IDEAONE17012)	1366	604	386	2	200	5012	138,00



SUPPORTO IN POLIETILENE PER RIALZO

ART.	supporto				per fusti		colore	€
	rif.	L mm	P mm	H mm	n.	L		
FAX002068000005 (IDEAONE21005)	A	465	610	410	1	200	giallo	129,00
FAX002070000005 (IDEAONE21006)	B	1200	780	255	2	200	giallo	315,00



VASCA DI RACCOLTA IN POLIETILENE CON GRIGLIA PER FUSTI

ART.	rif.	supporto			volume di contenimento lt.	adatto per art.	per fusti		colore	€
		L mm	P mm	H mm			n.	L		
FAX002064000005 (IDEAONE21001)	C	925	800	420	225	-	1	200	giallo	321,00
FAX002065000005 (IDEAONE21002)	D	1350	800	420	305	FAX002068000005	2	200	giallo	549,00
FAX002066000005 (IDEAONE21003)	E	1350	1350	460	500	FAX002070000005	4	200	giallo	750,00



vedi pag. 3



VASCA DI SICUREZZA IN POLIETILENE CON GRIGLIA PER CONTENITORE

ART.	supporto					per contenitore		colore	€
	rif.	L mm	P mm	H mm	volume di contenimento lt.	n.	L		
FAX002067000005 (IDEAONE21004)	F	1350	1350	950	1050	1	1000	giallo	1.080,00



vedi pag. 3

ECOLOGIA

ARMADI PORTE A BATTENTE



CONFIGURE

BREVETTATO*

ART.	L mm	P mm	H mm	KG	RAL	€
PERFOM14025	1023	555	2000	800	1004	558,60
PERFOM14026	1023	555	2000	800	7035+7016	558,60
PERFOM14027	1023	555	2000	800	7035	558,60
PERFOM14028	1023	555	2000	800	5012	558,60

COMPOSTO DA:

- 1 armadio a porte battente fessurate
- 1 kit 3 piani fessurati
- 1 vasca stagna esterna raccolta liquidi



vedi pag. 3



CONFIGURE

ART.	L mm	P mm	H mm	KG	RAL	€
PERFOM14029	1023	555	2000	800	1004	600,00
PERFOM14030	1023	555	2000	800	7035+7016	600,00
PERFOM14031	1023	555	2000	800	7035	600,00
PERFOM14032	1023	555	2000	800	5012	600,00

COMPOSTO DA:

- 1 armadio a porte battente fessurate
- 2 kit 2 vasche tenuta stagna



vedi pag. 3



CONFIGURE

BREVETTATO*

ART.	L mm	P mm	H mm	KG	RAL	€
PERFOM14022	1023	555	2000	800	7035+7016	1.581,30
PERFOM14023	1023	555	2000	800	7035	1.581,30
PERFOM14024	1023	555	2000	800	5012	1.581,30

COMPOSTO DA:

- 1 armadio a porte battente fessurate
- 1 kit 1 piano fessurato
- 3 kit piani fessurati con 2 separatori e 6 taniche
- 1 kit 1 vasca tenuta stagna
- 1 vasca stagna esterna raccolta liquidi



CONFIGURE



BREVETTATO*

ART.	L mm	P mm	H mm	KG	RAL	€
PERFORM12013	1023	555	1000	800	1004	448,80
PERFORM12014	1023	555	1000	800	7035+7016	448,80
PERFORM12015	1023	555	1000	800	7035	448,80
PERFORM12016	1023	555	1000	800	5012	448,80

COMPOSTO DA:

- 1 armadio a porte battente fessurate
- 1 piano fessurato
- 1 vasca stagna esterna raccolta liquidi



vedi pag. 3



CONFIGURE



ART.	L mm	P mm	H mm	KG	RAL	€
PERFORM12017	1023	555	1000	800	1004	435,00
PERFORM12018	1023	555	1000	800	7035+7016	435,00
PERFORM12019	1023	555	1000	800	7035	435,00
PERFORM12020	1023	555	1000	800	5012	435,00

COMPOSTO DA:

- 1 armadio a porte battente fessurate
- 1 kit 2 vasche stagne interne raccolta liquidi



vedi pag. 3



CLEVER - COMBI

CARRELLI



FACILI DA MONTARE



PORTATA PIANI
100 kg



CONFIGURABILE

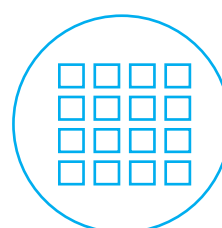

FORI QUADRI
10x10

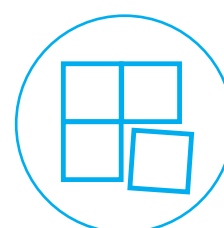

COMPONIBILI

CLEVER SMALL

CONFIGURE 



A

CONFIGURE 



B

ART.	rif.	carrello								ruote			RAL	€
		L mm	P mm	H mm	pannelli forati	coppia porte	piani in acciaio	piani in legno	cassetti	Ø	KG	materiale		
CLEVER0903	A	904	515	817	-	-	2	-	-	100	225	gomma standard	7035	132,00
CLEVER0904	A	904	515	817	-	-	2	-	-	100	225	gomma standard	5012	132,00
CLEVER0905	B	904	515	817	-	-	3	-	-	100	225	gomma standard	7035	171,00
CLEVER0906	B	904	515	817	-	-	3	-	-	100	225	gomma standard	5012	171,00

CONFIGURE 



ART.	L mm	P mm	H mm	KG	RAL	€
CLEVER0907	904	515	847	300	7035	183,00
CLEVER0908	904	515	847	300	5012	183,00

COMPOSTO DA:

- 1 carrello serie clever small smontato senza ruote
- 1 kit ruote in gomma antistrada sintetica Ø 125 mm
- 1 piano aggiuntivo

CLEVER LARGE

CONFIGURE 



A

CONFIGURE 



B

CONFIGURE 



C

CONFIGURE 



D

CONFIGURE 



E

CONFIGURE 



F

ART.	rif.	carrello								ruote			RAL	€
		L mm	P mm	H mm	pannelli forati	coppia porte	piani in acciaio	piani in legno	cassetti	Ø	KG	materiale		
CLEVER1003	A	1024	615	817	-	-	2	-	-	100	225	gomma standard	7035	144,00
CLEVER1004	A	1024	615	817	-	-	2	-	-	100	225	gomma standard	5012	144,00
CLEVER1005	B	1024	615	847	-	-	3	-	-	125	300	gomma standard	7035	193,50
CLEVER1006	B	1024	615	847	-	-	3	-	-	125	300	gomma standard	5012	193,50
CLEVER1007	C	1024	615	847	-	-	3	-	-	125	300	antitraccia sintetica	7035	202,50
CLEVER1008	C	1024	615	847	-	-	3	-	-	125	300	antitraccia sintetica	5012	202,50
CLEVER1009	D	1024	615	870	-	-	2	1	-	125	300	antitraccia sintetica	7035	234,00
CLEVER1010	D	1024	615	870	-	-	2	1	-	125	300	antitraccia sintetica	5012	234,00
CLEVER1011	E	1024	615	847	2	-	3	-	-	125	300	antitraccia sintetica	7035	268,50
CLEVER1012	E	1024	615	847	2	-	3	-	-	125	300	antitraccia sintetica	5012	268,50
CLEVER1013	F	1024	615	870	2	-	2	1	-	125	300	antitraccia sintetica	7035	300,00
CLEVER1014	F	1024	615	870	2	-	2	1	-	125	300	antitraccia sintetica	5012	300,00

CLEVER LARGE

CONFIGURE 



G

CONFIGURE 



H

CONFIGURE 



I

CONFIGURE 



L

CONFIGURE 



M

CONFIGURE 



N

ART.	rif.	carrello								ruote			RAL	€
		L mm	P mm	H mm	pannelli forati	coppia porte	piani in acciaio	piani in legno	cassetti	Ø	KG	materiale		
CLEVER1015	G	1024	615	870	3	-	2	1	-	125	300	antitraccia sintetica	7035	349,50
CLEVER1016	G	1024	615	870	3	-	2	1	-	125	300	antitraccia sintetica	5012	349,50
CLEVER1017	H	1024	615	870	3	1	2	1	-	125	300	antitraccia sintetica	7035	493,50
CLEVER1018	H	1024	615	870	3	1	2	1	-	125	300	antitraccia sintetica	5012	493,50
CLEVER1019	I	1024	615	847	-	-	3	-	1	125	300	antitraccia sintetica	7035+7016	306,00
CLEVER1020	I	1024	615	847	-	-	3	-	1	125	300	antitraccia sintetica	5012	301,50
CLEVER1021	L	1024	615	1540	3	-	2	1	-	125	300	antitraccia sintetica	7035	370,50
CLEVER1022	L	1024	615	1540	3	-	2	1	-	125	300	antitraccia sintetica	5012	370,50
CLEVER1023	M	1024	615	1540	4	1	2	1	-	125	300	antitraccia sintetica	7035	564,00
CLEVER1024	M	1024	615	1540	4	1	2	1	-	125	300	antitraccia sintetica	5012	564,00
CLEVER1025	N	1024	615	1540	1	-	2	1	1	125	300	antitraccia sintetica	7035+7016	408,00
CLEVER1026	N	1024	615	1540	1	-	2	1	1	125	300	antitraccia sintetica	5012	403,50

CLEVER LARGE

CONFIGURE 



ART.	L mm	P mm	H mm	KG	RAL	€
CLEVER1027	1024	615	1540	300	7035	582,00
CLEVER1028	1024	615	1540	300	5012	582,00

COMPOSTO DA:

- 1 carrello smontato senza ruote
- 1 piano in legno
- 1 pannello posteriore forato
- 1 coppia montanti per fissaggio pannello
- 2 pannelli laterali forati
- 1 kit ruote in gomma antitraccia sintetica Ø 125 mm
- 1 kit porta rotolo con carta Ø 240/300 mm
- 2 kit 10 calamite Ø 20 mm
- 1 barra aggancio contenitori con 3 contenitori Picking Box mis. 2
- 1 mensola grande reversibile
- 1 porta bombolette a 6 posti
- 2 porta silicone inclinato a 2 posti

CLEVER SMALL - LARGE COMPONENTI

CARRELLO SERIE CLEVER SMONTATO SENZA RUOTE

ART.	carrello	L mm	P mm	H mm	KG	RAL	€
FCR10S0X208	SMALL	904	515	690	300	7035	102,00
FCR10S0X204	SMALL	904	515	690	300	5012	102,00
FCR11S0X208	LARGE	1024	615	690	300	7035	114,00
FCR11S0X204	LARGE	1024	615	690	300	5012	114,00



SMALL

LARGE

KIT RUOTE

ART.	Ø	KG	H mm	materiale			€
FKRD1002107	100	225	128	gomma standard	2	2	30,00
FKRB1252107	125	300	155	gomma standard	2	2	33,00
FKRU1252101	125	300	155	gomma antitraccia sintetica	2	2	42,00
FKRS1252101	125	750	155	gomma elastica	2	2	69,00

 ruota girevole con freno

 ruota fissa



PANNELLO LATERALE FORATO

ART.	L mm	P mm	H mm	per carrello	RAL	€
FCR11140108	573	3	688	LARGE	7035	33,00
FCR11140104	573	3	688	LARGE	5012	33,00



PANNELLO POSTERIORE FORATO

ART.	L mm	P mm	H mm	per carrello	RAL	€
FCR11150108	895	18	690	LARGE	7035	49,50
FCR11150104	895	18	690	LARGE	5012	49,50



CLEVER SMALL - LARGE COMPONENTI

PANNELLO POSTERIORE FORATO

ART.	L mm	P mm	H mm	per carrello	RAL	€
FCR11150108	895	18	690	LARGE	7035	49,50
FCR11150104	895	18	690	LARGE	5012	49,50



PER INSTALLARE IL PANNELLO FORATO NELLA PARTE SUPERIORE DEL CARRELLO È OBBLIGATORIO ORDINARE LA COPPIA STAFFE.

COPPIA MONTANTI PER FISSAGGIO PANNELLO

ART.	L mm	P mm	H mm	RAL	€
FCR10170139	35	45	690	7016	21,00



COPPIA PORTE BATTENTE

ART.	L mm	P mm	H mm	per carrello	RAL	€
FCR11160108	890	23	690	LARGE	7035	144,00
FCR11160104	890	23	690	LARGE	5012	144,00



PIANO AGGIUNTIVO PER CARRELLO

ART.	L mm	P mm	H mm	KG	per carrello	RAL	€
FCR10120108	810	510	35	100	SMALL	7035	39,00
FCR10120104	810	510	35	100	SMALL	5012	39,00
FCR11120108	930	610	35	100	LARGE	7035	46,50
FCR11120104	930	610	35	100	LARGE	5012	46,50



CLEVER SMALL - LARGE COMPONENTI



PIANO IN LEGNO CON SUPPORTI

ART.	L mm	P mm	H mm	per carrello	KG	€
FCR11130100	930	610	25	LARGE	100	78,00



ARMADIO CON 1 CASSETTO

ART.	L mm	P mm	H mm	KG	RAL	€
FBG03S50C0001PD (IDEAONE06099)	500	607	210	25	7035+7016	103,50
FBG03S50C000104 (IDEAONE06035)	500	607	210	25	5012	99,00

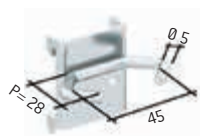
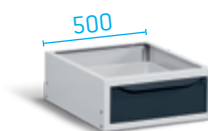

CMV10001
(IDEAONE05092)



CMV10016
(IDEAONE05093)



CMV10022
(IDEAONE05094)

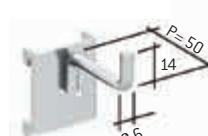

CMV10036
(IDEAONE05095)

GANCI

IRON TEAM vedi pag. 62



FBL95410000
(IDEAONE05108)



FBLIT008039
(IDEAONE05216)



FBLIT004039
(IDEAONE05163)



FBLIT010039
(IDEAONE05220)



FBLIT013000
(IDEAONE05223)



FBLIT017039
(IDEAONE05205)

IRON TEAM ELECTRIC

vedi pag. 68-70



FBLET012007
(IDEAONE05178)



FBLET004007
(IDEAONE05165)



FBLET005007
(IDEAONE05166)



FBLET016007
(IDEAONE05179)

CLEVER LARGE

CONFIGURE



ART.	L mm	P mm	H mm	KG	RAL	€
CLEVER1029	1024	615	1540	300	7035	937,50
CLEVER1030	1024	615	1540	300	5012	937,50

BREVETTATO*

COMPOSTO DA:

- 1 carrello smontato senza ruote
- 1 piano in legno con supporti
- 2 pannelli posteriori forati
- 1 coppia montanti per fissaggio pannello
- 1 coppia porte battente
- 2 pannelli laterali forati
- 1 kit ruote in gomma antitraccia sintetica Ø 125 mm
- 1 kit porta rotolo con carta Ø 240/300 mm
- 2 kit 10 calamite Ø 20 mm
- 2 mensole grandi reversibili
- 1 porta bombole a 6 posti
- 1 cestino capacità 30 lt
- 1 supporto multipresa a 2 scomparti
- 1 supporto multipresa a 4 scomparti
- 1 multipresa Schuko a 2 scomparti
- 1 multipresa Schuko a 4 scomparti
- 1 cavo di collegamento wieland Schuko/FR

COMBI



CARRELLO CON FRENO E BASE IN ACCIAIO

carrello					ruote						RAL	€
ART.	L mm	P mm	H mm	KG	∅	KG	materiale					
FCEP1052004 (IDEAONE08043)	1095	700	1000	500	200	205	gomma standard	1	1	2	5012	294,00

ruota girevole

ruota girevole con freno

ruota fissa



CARRELLO CON FRENO E BASE IN ACCIAIO

carrello					ruote						RAL	€
ART.	L mm	P mm	H mm	KG	∅	KG	materiale					
FCEB1050308 (IDEAONE08012)	1135	700	915	250	125	100	gomma standard	1	1	2	7035	144,00
FCEB1050304 (IDEAONE08005)	1135	700	915	250	125	100	gomma standard	1	1	2	5012	144,00

ruota girevole

ruota girevole con freno

ruota fissa



CARRELLO SENZA FRENI CON BASE IN ACCIAIO

carrello					ruote				RAL	€
ART.	L mm	P mm	H mm	KG	∅	KG	materiale			
FCR00210008 (IDEAONE08036)	555	445	845	150	100	75	gomma standard	4	7035	114,00
FCR00210004 (IDEAONE08035)	555	445	845	150	100	75	gomma standard	4	5012	114,00

ruota fissa

SMART

CARRELLI PER PICKING BOX - VISUAL BOX

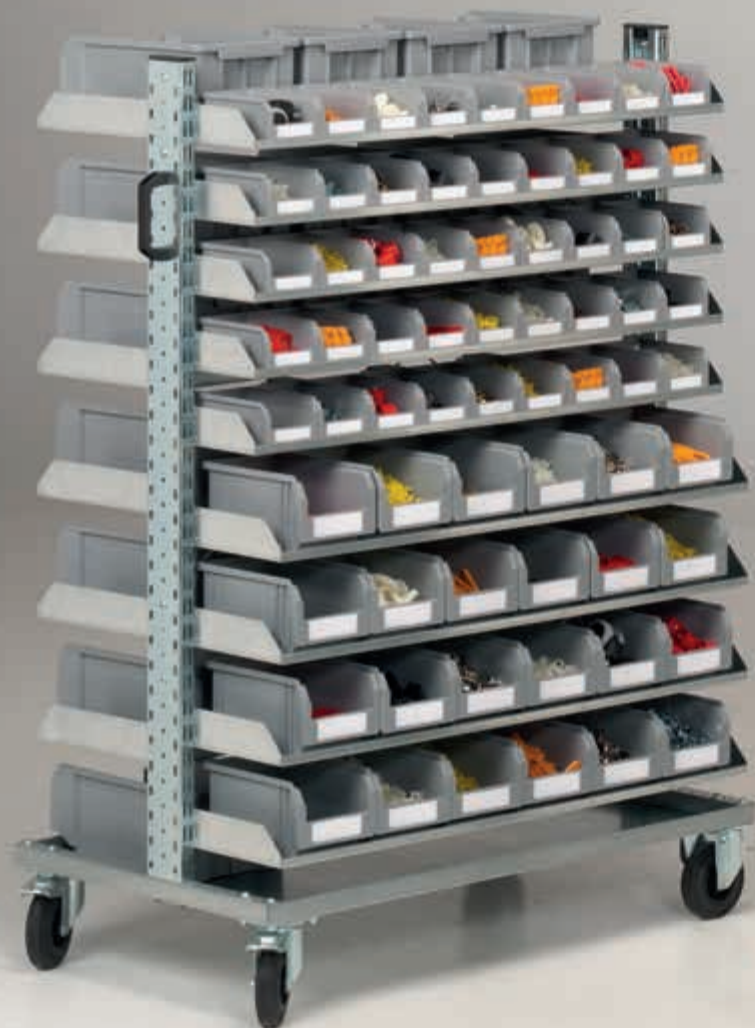

FACILI DA MONTARE



PORTATA CARRELLO
300 kg

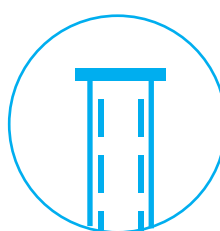

MONTANTE FORATO
PASSO 38 mm

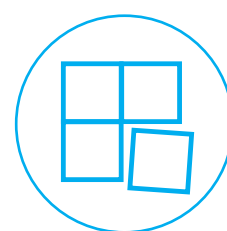

COMPONIBILI

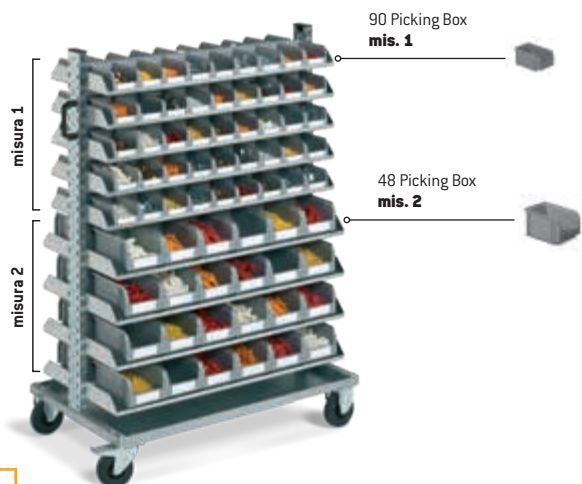

A

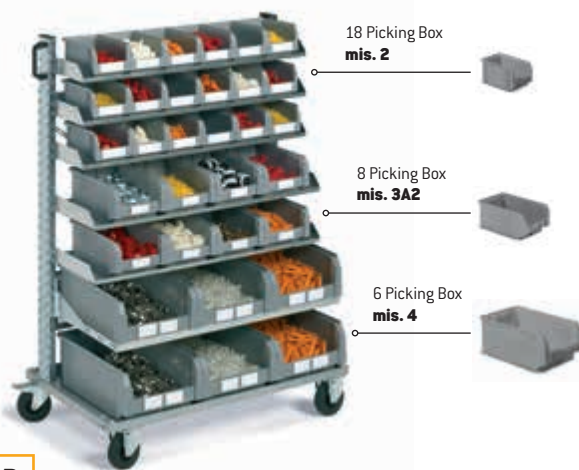

B

ART.	carrello					ruote			RAL	€			
	ref.	L mm	P mm	H mm	KG	Ø	KG	materiale			↺	↻	⬇
FLBB1026352 (IDEAONE11007)	A	1023	613	1430	300 (150 per lato)	125	100	gomma standard	1	1	2	7000 + ZINCATO	528,00
FLBB1015352 (IDEAONE11273)	B	1023	613	1430	300	125	100	gomma standard	1	1	2	7000 + ZINCATO	387,00

↺ ruota girevole

↻ ruota girevole con freno

⬇ ruota fissa

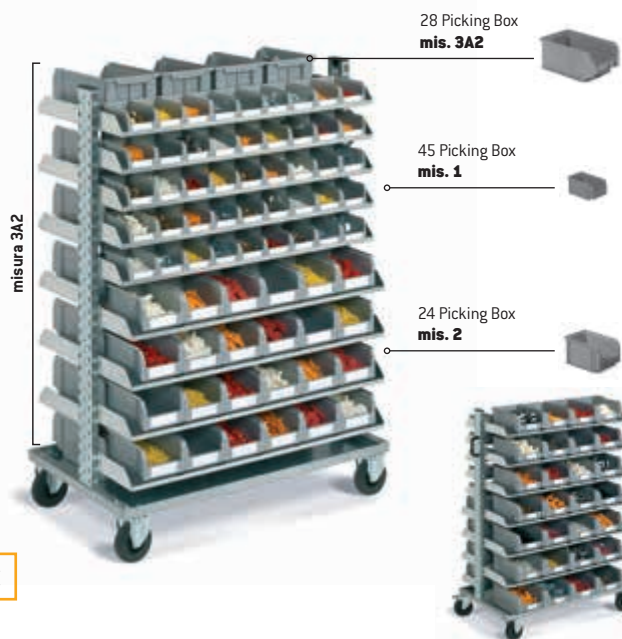

C



D

ART.	carrello					ruote			RAL	€			
	ref.	L mm	P mm	H mm	KG	Ø	KG	materiale			↺	↻	⬇
FLBB1026452 (IDEAONE11275)	C	1023	613	1430	300 (150 per lato)	125	100	gomma standard	1	1	2	7000 + ZINCATO	525,00
FLBB0735452 (IDEAONE11008)	D	725	613	1430	300 (150 per lato)	125	100	gomma standard	1	1	2	7000 + ZINCATO	534,00

↺ ruota girevole

↻ ruota girevole con freno

⬇ ruota fissa

ST

SCAFFALI



FACILI DA MONTARE

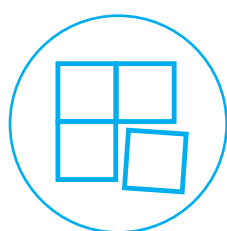

COMPONIBILI

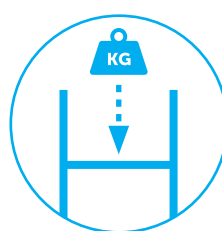

PORTATA PIANI
FINO A 300 KG



PORTATA CAMPATA
2300 KG

CONFIGURE



ART.	L mm	P mm	H mm	colore	€
ST2001	2100	500	2000	zincato	363,00

COMPOSTO DA:

- 3 fiancate con traversini
- 2 kit 5 piani fessurati 1000x500 mm



KIT 5 RINFORZI PER PIANI FESSURATI

ART.	L mm	colore	€
FUF20000199 (IDEAONE15039)	1000	zincato	21,00

[aumenta la portata dei piani fessurati a 300 kg]



KIT 5 PIANI FESSURATI

ART.	L mm	P mm	H mm	KG	colore	€
FST10402099 (IDEAONE15036)	1000	400	35	120	zincato	105,00
FST10502099 (IDEAONE15037)	1000	500	35	120	zincato	114,00

CONFIGURE



ART.	L mm	P mm	H mm	colore	€
ST2601	2700	400	2000	zincato	280,50

COMPOSTO DA:

- 3 fiancate con traversini
- 2 kit 3 coppie supporti porta pneumatici



KIT 3 COPPIE SUPPORTI PORTA PNEUMATICI

ART.	L mm	colore	€
FST95900199 (IDEAONE15038)	1300	zincato	75,00



FIANCATA CON TRAVERSINI

ART.	P mm	H mm	colore	€
FST02034099 (IDEAONE15034)	400	2000	zincato	43,50
FST02035099 (IDEAONE15035)	500	2000	zincato	45,00

STORAGE DOMINO

SCAFFALI

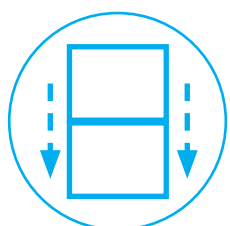

SOVRAPPONIBILI

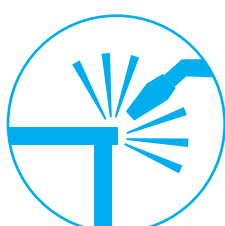

**STRUTTURA
SALDATA**



**PORTATA MODULO
FINO A 1600 KG**



**FERMO
ANTICADUTA**

STORAGE DOMINO

SCAFFALI CON CONTENITORI IN PLASTICA

CONFIGURE



ART.	L mm	P mm	H mm	RAL	€
FED30440101	1025	310	885	7000	300,00

COMPOSTO DA:

- 1 scaffale
- 16 contenitori Picking Box grigi mis. 3



SOVRAPPONIBILITÀ

telai sovrapposti	 di ogni telaio	 di ogni box
2	960	60
max 3	640	40

CONFIGURE



ART.	L mm	P mm	H mm	RAL	€
FED40540101	1765	460	885	7000	459,00

COMPOSTO DA:

- 1 scaffale
- 20 contenitori Picking Box grigi mis. 4

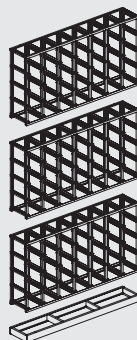

SOVRAPPONIBILITÀ

telai sovrapposti	 di ogni telaio	 di ogni box
max 3	1600	80

STORAGE DOMINO

SCAFFALI CON CONTENITORI IN METALLO

CONFIGURE



ART.	L mm	P mm	H mm	RAL	€
FED30440201	1025	310	885	7000	468,00

COMPOSTO DA:

- 1 scaffale
- 16 contenitori STEEL mis. 3

SOVRAPPONIBILITÀ



telai sovrapposti	KG di ogni telaio	KG di ogni box
2	960	60
max 3	640	40

CONFIGURE



ART.	L mm	P mm	H mm	RAL	€
FED40540201	1765	460	885	7000	702,00

COMPOSTO DA:

- 1 scaffale
- 20 contenitori STEEL mis. 4

SOVRAPPONIBILITÀ

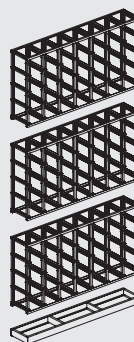

telai sovrapposti	KG di ogni telaio	KG di ogni box
max 3	1600	80

STORAGE DOMINO

SCAFFALI VUOTI - COPERCHI - ZOCCOLI

CONFIGURE



SCAFFALE VUOTO

ART.	L mm	P mm	H mm	RAL	€
FED30440A01 (IDEAONE19002)	1025	310	885	7000	228,00

CONFIGURE



SCAFFALE VUOTO

ART.	L mm	P mm	H mm	RAL	€
FED40540A01 (IDEAONE19005)	1765	460	885	7000	270,00



COPERCHIO PARAPOLVERE

ART.	L mm	P mm	H mm	RAL	€
FED90340001 (IDEAONE19001)	1020	315	20	7000	25,20



COPERCHIO PARAPOLVERE

ART.	L mm	P mm	H mm	RAL	€
FED90450001 (IDEAONE19004)	1765	465	20	7000	33,00



ZOCCOLO DI APPOGGIO

ART.	L mm	P mm	H mm	RAL	€
FED92340001 (IDEAONE19003)	1020	315	85	7000	45,00



ZOCCOLO DI APPOGGIO

ART.	L mm	P mm	H mm	RAL	€
FED92450001 (IDEAONE19006)	1765	465	85	7000	54,00

STEEL

CASSETTE, CONTENITORI E CONTAINERS IN METALLO

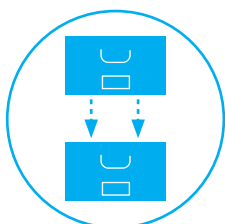

IMPILABILI

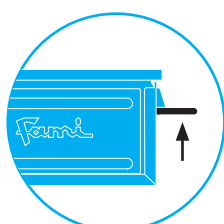

**MANIGLIA
BLOCCO A 90°**

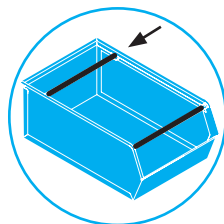

**TRASVERSINO DI
SOLLEVAMENTO**

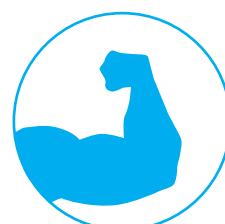

ROBUSTI

STEEL

CASSETTE IN METALLO



A



B



C



D



E

ART.	rif.	multiplo d'ordine	mis.	dim. ingombro			dim. utili			L	RAL	€ cadauno
				L mm	P mm	H mm	L mm	P mm	H mm			
FLA33200A01	A	10	272-3A2	300	200	145	290	183	132	8,7	7000	18,30
FLA41200A01 <small>(IDEAONE13002)</small>	B	8	272-3	300	200	200	290	186	184	12	7000	20,40
FLA65200A01 <small>(IDEAONE13001)</small>	C	6	272-4	450	300	200	442	285	182	27	7000	24,30
FLA73200A01	D	4	272-4A5	450	300	300	440	280	278	40,5	7000	41,70
FLA89200A01	E	6	272-5	630	450	300	617	430	278	85	7000	61,50



STEEL

CONTENITORI IN METALLO



A



B



C



D



E



F



G



H

ART.	rif.	multiplo d'ordine	mis.	dim. ingombro			dim. utili			L	RAL	€ cadauno
				L mm	P mm	H mm	L mm	P mm	H mm			
FLS17000A01	A	20	1	95	160	75	86	138	66	1	7000	4,20
FLS25000A01	B	20	2	140	230	130	131	196	113	3,8	7000	10,80
FLS33000A01	C	10	3A2	200	350	145	181	298	135	9,4	7000	15,90
FLS41000A01 (IDEAONE13003)	D	8	3	200	350	200	185	300	184	12,5	7000	16,20
FLS49000A01	E	9	3P4	200	500	200	184	448	184	18	7000	25,20
FLS57000A01	F	8	4A2	300	500	145	281	448	135	20	7000	28,80
FLS65000A01 (IDEAONE13004)	G	6	4	300	500	200	284	448	185	28	7000	21,90
FLS73000A01	H	4	4A5	300	520	300	288	446	278	42	7000	38,10



TRAVERSINO DI SOLLEVAMENTO
ABBINATO ALLA MANIGLIA BLOCCO
A 90°

**I****L****M****N****O****P****Q****R**

ART.	rif.	multiplo d'ordine	mis.	dim. ingombro			dim. utili			L	RAL	€ cadauno
				L mm	P mm	H mm	L mm	P mm	H mm			
FLS81000A01	I	6	5P4	450	520	300	448	428	278	63	7000	49,80
FLS89000A01	L	6	5	450	700	300	630	428	278	88	7000	49,50
FLS65010A01	M	6	4	300	500	200	448	284	185	28	7000	28,80
FLS73010A01	N	4	4A5	300	520	300	446	288	278	42	7000	45,00
FLS81010A01	O	6	5P4	450	520	300	448	428	278	63	7000	60,90
FLS89010A01	P	4	5	450	700	300	630	428	278	88	7000	60,00
FLS81100A01	Q	4	5P4	450	520	300	448	428	248	63	7000	70,50
FLS89100A01	R	4	5	450	700	300	630	428	278	88	7000	72,00

APPLICAZIONI SPECIALI

CONTENITORI CON DOPPIO TRAVERSINO

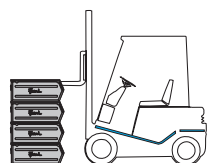

sistema di prelievo con carrello elevatore

CONTENITORI CON SLITTA

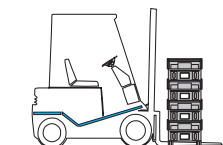

sistema di prelievo con carrello elevatore

STEEL

CONTAINERS



CONTAINER CON FONDO APRIBILE A RULLI

ART.	L mm	P mm	H mm	KG	RAL	€
FML01210001	1000	800	1150	2000	7000	660,00



CONTAINER CON FONDO APRIBILE A RULLI

ART.	L mm	P mm	H mm	KG	RAL	€
FML01110001	1000	800	800	2000	7000	582,00

CONTAINERS CON FONDO APRIBILE A RULLI

Sollevati con carrello elevatore tramite le quattro maniglie saldate al bordo superiore, consentono di scaricare il materiale per mezzo del fondo apribile a rulli (apertura del 87%). L'apertura avviene in modo facile e sicuro tramite la leva posta sul lato da 800 mm, mentre la chiusura mediante un particolare dispositivo composto di leve e rulli d'acciaio.

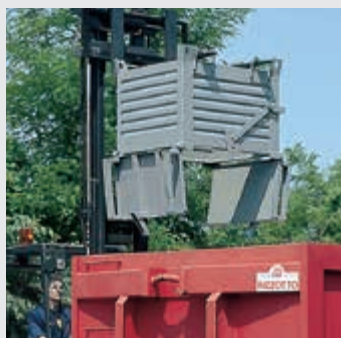

1.



2.



3.



4.



CONTAINER A BOCCA DI LUPO

ART.	multiplo d'ordine	L mm	P mm	H mm	KG	RAL	€ cadauno
FML05100A01	3	800	700	600	1000	7000	162,00



EURO BOX - NESTABLE BOX

PICKING BOX - VISUAL BOX

CASSETTE E CONTENITORI IN PLASTICA



POLIPROPILENE



ECOGREEN



ABS



POLISTIROLO



POLIETILENE

EURO BOX 300x200 POLIPROPILENE

FONDO LISCIO

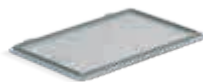

A

B

C

ART.	rif.	mis.	dim. ingombro			dim. utili			L	colore	€
			L mm	P mm	H mm	L mm	P mm	H mm			
FAXEB3212A05101 (IDEAONE09066)	A	3212	300	200	120	259	160	116	5	grigio	4,80
FAXEB3217A05101 (IDEAONE09067)	B	3217	300	200	170	259	160	166	7	grigio	5,10
FAXEB32HG005101 (IDEAONE09068)	C	-	300	200	-	-	-	-	-	grigio	2,70

EURO BOX 400x300 POLIPROPILENE

FONDO LISCIO

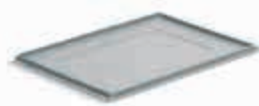

A

B

C

D

E

ART.	rif.	mis.	dim. ingombro			dim. utili			L	colore	€
			L mm	P mm	H mm	L mm	P mm	H mm			
FAXEB4312A05101 (IDEAONE09061)	A	4312	400	300	120	355	255	116	10	grigio	6,30
FAXEB4317A05101 (IDEAONE09062)	B	4317	400	300	170	355	255	166	15	grigio	8,10
FAXEB4322A05101 (IDEAONE09063)	C	4322	400	300	220	355	255	216	20	grigio	8,70
FAXEB4332A05101 (IDEAONE09064)	D	4332	400	300	325	355	255	321	30	grigio	12,60
FAXEB43HG005101 (IDEAONE09065)	E	-	400	300	-	-	-	-	-	grigio	3,60

EURO BOX 600x400 POLIPROPILENE

FONDO LISCIO



A



B



C

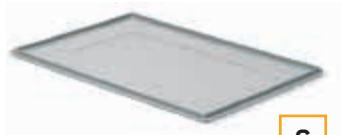

G



D



E



F

ART.	rif.	mis.	dim. ingombro			dim. utili			L	colore	€
			L mm	P mm	H mm	L mm	P mm	H mm			
FAXEB6412A05101 (IDEAONE10062)	A	6412	600	400	120	555	355	116	20	grigio	10,50
FAXEB6417A05101 (IDEAONE10063)	B	6417	600	400	170	555	355	166	30	grigio	12,90
FAXEB6422A05101 (IDEAONE10064)	C	6422	600	400	220	555	355	216	40	grigio	16,80
FAXEB6428A05101 (IDEAONE10068)	D	6428	600	400	285	555	355	276	53	grigio	19,50
FAXEB6432A05101 (IDEAONE10065)	E	6432	600	400	325	555	355	321	60	grigio	21,60
FAXEB6443B05101 (IDEAONE10067)	F	6443	600	400	430	555	355	426	90	grigio	27,90
FAXEB64HG005101 (IDEAONE10066)	G	-	600	400	-	-	-	-	-	grigio	6,90



CARRELLO CON MANIGLIA PER EURO BOX

ART.	carrello				ruote				colore	€
	L mm	P mm	H mm	KG	Ø	materiale	ruota			
FCP20110299	695	415	870	150	100	gomma standard	4	zincato	102,00	

ruota girevole



CARRELLO PER EURO BOX

ART.	carrello				ruote				colore	€
	L mm	P mm	H mm	KG	Ø	materiale	ruota			
FCP20110199	615	415	170	150	100	gomma standard	4	zincato	66,00	

ruota girevole

EURO BOX 800x600 POLIPROPILENE

FONDO RINFORZATO



A



B



C



D



E



F

ART.	rif.	mis.	dim. ingombro			dim. utili			L	colore	€
			L mm	P mm	H mm	L mm	P mm	H mm			
FAXEB8612C05101 (IDEAONE09069)	A	8612	800	600	120	755	555	101	49	grigio	26,70
FAXEB8617C05101 (IDEAONE09070)	B	8617	800	600	170	755	555	151	69	grigio	28,80
FAXEB8622C05101 (IDEAONE09071)	C	8622	800	600	220	755	555	201	90	grigio	29,70
FAXEB8632C05101 (IDEAONE09072)	D	8632	800	600	325	755	555	306	130	grigio	33,90
FAXEB8643C05101 (IDEAONE09073)	E	8643	800	600	430	755	555	411	175	grigio	39,00
FAXEB86SE005101 (IDEAONE09074)	F	-	800	600	-	-	-	-	-	grigio	11,10



KIT RUOTE

ART.	Ø	KG	H mm	materiale			€
FKRD1002107 (IDEAONE09075)	100	75	128	gomma standard	2	2	30,00

ruota girevole con freno

ruota fissa

SET VITI PER FISSAGGIO RUOTE SU CASSETTA FAMI EURO BOX



ART.	pz. per confezione	€
FVT01380000	16	2,40

EURO BOX 400x300 ECOGREEN

FONDO LISCIO



A



B



C



D



E

ART.	rif.	mis.	dim. ingombro			dim. utili			L	colore	€
			L mm	P mm	H mm	L mm	P mm	H mm			
FAXEB4312A05401 (IDEAONE09005)	A	4312	400	300	120	355	255	116	10	grigio scuro	5,40
FAXEB4317A05401 (IDEAONE09006)	B	4317	400	300	170	355	255	166	15	grigio scuro	6,90
FAXEB4322A05401 (IDEAONE09007)	C	4322	400	300	220	355	255	216	20	grigio scuro	7,50
FAXEB4332A05401 (IDEAONE09055)	D	4332	400	300	325	355	255	321	30	grigio scuro	10,20
FAXEB43HG005401 (IDEAONE09009)	E	-	400	300	-	-	-	-	-	grigio scuro	3,00

EURO BOX 600x400 ECOGREEN

FONDO LISCIO



A



B



C



D



E

ART.	rif.	mis.	dim. ingombro			dim. utili			L	colore	€
			L mm	P mm	H mm	L mm	P mm	H mm			
FAXEB6412A05401 (IDEAONE10005)	A	6412	600	400	120	555	355	116	20	grigio scuro	9,00
FAXEB6417A05401 (IDEAONE10006)	B	6417	600	400	170	555	355	166	30	grigio scuro	10,80
FAXEB6422A05401 (IDEAONE10055)	C	6422	600	400	220	555	355	216	40	grigio scuro	13,50
FAXEB6432A05401 (IDEAONE10056)	D	6432	600	400	325	555	355	321	60	grigio scuro	17,40
FAXEB64HG005401 (IDEAONE10009)	E	-	600	400	-	-	-	-	-	grigio scuro	5,70

NESTABLE BOX LIGHT 600x400 POLIPROPILENE

FONDO LISCIO

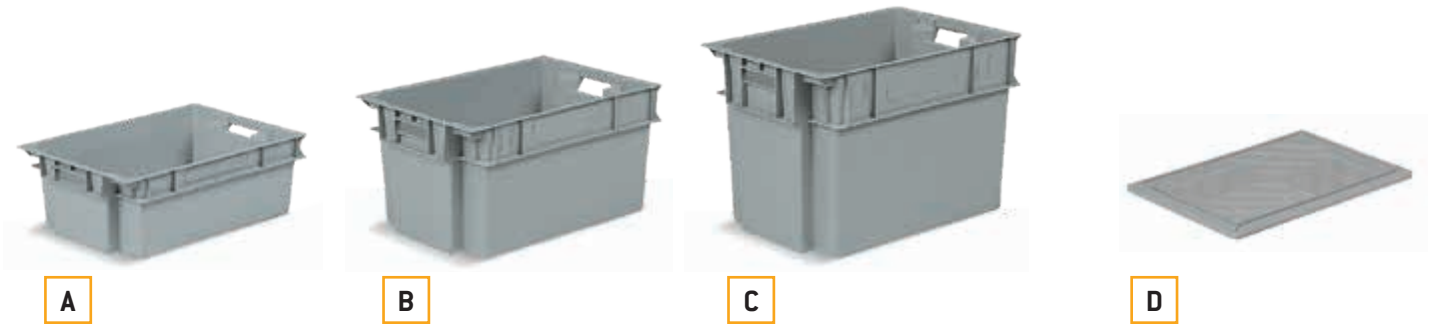

ART.	rif.	mis.	dim. ingombro			dim. utili			L	colore	€
			L mm	P mm	H mm	L mm	P mm	H mm			
FAXNL6420B05101 (IDEAONE09076)	A	6420	600	400	200	453	336	197	32	grigio	12,60
FAXNL6430B05101 (IDEAONE09077)	B	6430	600	400	300	453	336	297	50	grigio	18,90
FAXNL6440B05101 (IDEAONE09078)	C	6440	600	400	400	453	336	397	70	grigio	24,30
FAXNL64SE005101 (IDEAONE09079)	D	-	600	400	-	-	-	-	-	grigio	8,70

PICKING BOX ECOGREEN



ART.	rif.	multiplo d'ordine	mis.	dim. ingombro			dim. utili			L	colore	€ cadauno
				L mm	P mm	H mm	L mm	P mm	H mm			
FAXPBC001A05401 (IDEAONE11015)	A	50	1	102	168	75	88	134	65	1	grigio scuro	0,90
FAXPBC002A05401 (IDEAONE11025)	B	54	2	140	230	130	124	190	111	3,8	grigio scuro	1,50
FAXPBC3A2B05401 (IDEAONE11036)	C	21	3A2	200	350	145	182	285	130	9,4	grigio scuro	3,90
FAXPBC003B05401 (IDEAONE11035)	D	15	3	200	350	200	180	278	187	12,5	grigio scuro	4,50
FAXPBC004B05401 (IDEAONE11045)	E	10	4	300	500	200	281	435	186	28	grigio scuro	8,40

PICKING BOX POLIPROPILENE



A



B



C



D



E

ART.	rif.	multiplo d'ordine	mis.	dim. ingombro			dim. utili			L	colore	€ cadauno
				L mm	P mm	H mm	L mm	P mm	H mm			
FAXPBC001A05101 (IDEAONE11247)	A	50	1	102	168	75	88	134	65	1	grigio	1,20
FAXPBC001A05102 (IDEAONE11248)	A	50	1	102	168	75	88	134	65	1	verde	1,20
FAXPBC001A05103 (IDEAONE11249)	A	50	1	102	168	75	88	134	65	1	rosso	1,20
FAXPBC001A05104 (IDEAONE11250)	A	50	1	102	168	75	88	134	65	1	blu	1,20
FAXPBC001A05105 (IDEAONE11251)	A	50	1	102	168	75	88	134	65	1	giallo	1,20
FAXPBC002A05101 (IDEAONE11252)	B	54	2	140	230	130	124	190	111	3,8	grigio	1,80
FAXPBC002A05102 (IDEAONE11253)	B	54	2	140	230	130	124	190	111	3,8	verde	1,80
FAXPBC002A05103 (IDEAONE11254)	B	54	2	140	230	130	124	190	111	3,8	rosso	1,80
FAXPBC002A05104 (IDEAONE11255)	B	54	2	140	230	130	124	190	111	3,8	blu	1,80
FAXPBC002A05105 (IDEAONE11256)	B	54	2	140	230	130	124	190	111	3,8	giallo	1,80
FAXPBC3A2B05101 (IDEAONE11257)	C	21	3A2	200	350	145	182	285	130	9,4	grigio	4,50
FAXPBC3A2B05102 (IDEAONE11258)	C	21	3A2	200	350	145	182	285	130	9,4	verde	4,50
FAXPBC3A2B05103 (IDEAONE11259)	C	21	3A2	200	350	145	182	285	130	9,4	rosso	4,50
FAXPBC3A2B05104 (IDEAONE11260)	C	21	3A2	200	350	145	182	285	130	9,4	blu	4,50
FAXPBC3A2B05105 (IDEAONE11261)	C	21	3A2	200	350	145	182	285	130	9,4	giallo	4,50
FAXPBC003B05101 (IDEAONE11262)	D	15	3	200	350	200	180	278	187	12,5	grigio	5,10
FAXPBC003B05102 (IDEAONE11263)	D	15	3	200	350	200	180	278	187	12,5	verde	5,10
FAXPBC003B05103 (IDEAONE11264)	D	15	3	200	350	200	180	278	187	12,5	rosso	5,10
FAXPBC003B05104 (IDEAONE11265)	D	15	3	200	350	200	180	278	187	12,5	blu	5,10
FAXPBC003B05105 (IDEAONE11266)	D	15	3	200	350	200	180	278	187	12,5	giallo	5,10
FAXPBC4A2B05101	E	14	4A2	300	500	145	283	428	126	20	grigio	8,70
FAXPBC4A2B05102	E	14	4A2	300	500	145	283	428	126	20	verde	8,70
FAXPBC4A2B05103	E	14	4A2	300	500	145	283	428	126	20	rosso	8,70
FAXPBC4A2B05104	E	14	4A2	300	500	145	283	428	126	20	blu	8,70
FAXPBC4A2B05105	E	14	4A2	300	500	145	283	428	126	20	giallo	8,70



F



G



H



I

ART.	rif.	multiplo d'ordine	mis.	dim. ingombro			dim. utili			L	colore	€ cadauno
				L mm	P mm	H mm	L mm	P mm	H mm			
FAXPBC004B05101 (IDEAONE11267)	F	10	4	300	500	200	281	435	186	28	grigio	9,90
FAXPBC004B05102 (IDEAONE11268)	F	10	4	300	500	200	281	435	186	28	verde	9,90
FAXPBC004B05103 (IDEAONE11269)	F	10	4	300	500	200	281	435	186	28	rosso	9,90
FAXPBC004B05104 (IDEAONE11270)	F	10	4	300	500	200	281	435	186	28	blu	9,90
FAXPBC004B05105 (IDEAONE11271)	F	10	4	300	500	200	281	435	186	28	giallo	9,90
FAXPBC4A5B05101	G	6	4A5	300	500	300	284	424	284	42	grigio	12,00
FAXPBC4A5B05102	G	6	4A5	300	500	300	284	424	284	42	verde	12,00
FAXPBC4A5B05103	G	6	4A5	300	500	300	284	424	284	42	rosso	12,00
FAXPBC4A5B05104	G	6	4A5	300	500	300	284	424	284	42	blu	12,00
FAXPBC4A5B05105	G	6	4A5	300	500	300	284	424	284	42	giallo	12,00
FAXPBZ5P4E05101	H	-	5P4	450	520	300	434	432	275	63	grigio	22,50
FAXPBZ5P4E05102	H	-	5P4	450	520	300	434	432	275	63	verde	22,50
FAXPBZ5P4E05103	H	-	5P4	450	520	300	434	432	275	63	rosso	22,50
FAXPBZ5P4E05104	H	-	5P4	450	520	300	434	432	275	63	blu	22,50
FAXPBZ5P4E05105	H	-	5P4	450	520	300	434	432	275	63	giallo	22,50
FAXPBZ005E05101	I	-	5	450	700	300	434	615	275	88	grigio	28,50
FAXPBZ005E05102	I	-	5	450	700	300	434	615	275	88	verde	28,50
FAXPBZ005E05103	I	-	5	450	700	300	434	615	275	88	rosso	28,50
FAXPBZ005E05104	I	-	5	450	700	300	434	615	275	88	blu	28,50
FAXPBZ005E05105	I	-	5	450	700	300	434	615	275	88	giallo	28,50

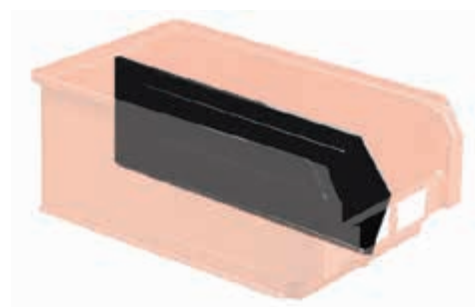

DIVISORIO LONGITUDINALE IN PLASTICA

ART.	multiplo d'ordine	per contenitore mis.	L mm	H mm	colore	€ cadauno
FAXPBDC3A207107 (IDEAONE9082)	10	3A2	300	105	nero	1,80
FAXPBDC00307107 (IDEAONE9080)	10	3	305	160	nero	2,40
FAXPBDC00407107 (IDEAONE9081)	10	4	460	160	nero	3,30



NERO



GRIGIO



VERDE



ROSSO



BLU



GIALLO



CAPACITÀ LITRI

VISUAL BOX ABS - POLISTIROLO

STRUTTURA IN ABS - CASSETTI IN POLISTIROLO



A



B



C



D



E



F

ART.	rif.	multiplo d'ordine	dim. ingombro			dim. utili			colore	€ cadauno
			L mm	P mm	H mm	L mm	P mm	H mm		
FAXVBCH00900001 (IDEAONE12001)	A	2	600	69	77	55	45	49	grigio + trasparente	12,30
FAXVBCH00600001 (IDEAONE12002)	B	2	600	98	112	81	64	72	grigio + trasparente	14,70
FAXVBCH00500001 (IDEAONE12003)	C	-	600	141	164	99	100	110	grigio + trasparente	23,40
FAXVBCH00400001 (IDEAONE12004)	D	-	600	174	206	128	130	135	grigio + trasparente	30,90
FAXVBCH00300001 (IDEAONE12005)	E	-	600	209	240	184	146	164	grigio + trasparente	36,30
FAXVBCH00200001 (IDEAONE12006)	F	-	600	311	353	610	325	365	grigio + trasparente	65,70



SCAFFALE VUOTO DA PARETE PER CASSETTIERE VISUAL BOX

ART.	L mm	P mm	H mm	RAL	€
FVBSW1500000001 (IDEAONE12007)	600	41	1500	7000	34,80
FVBSW1950000001 (IDEAONE12011)	600	41	1950	7000	38,10

BASE PER SCAFFALE

ART.	L mm	P mm	H mm	RAL	€
FVBSBASE00000001 (IDEAONE12014)	600	300	100	7000	27,00



MAT POLIETILENE

TAPPETI ANTISDRUCCIOLO



TAPPETO ANTISDRUCCIOLO CHIUSO

ART.	L mm	P mm	H mm	colore	€
FAXSMTC08004001	800	400	25	grigio scuro	14,40
FAXSMTC08004006	800	400	25	rosso mattone	14,40

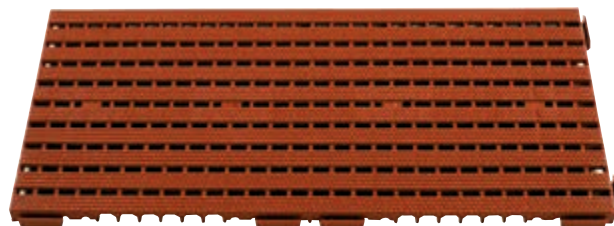

TAPPETO ANTISDRUCCIOLO APERTO

ART.	L mm	P mm	H mm	colore	€
FAXSMTA08004001	800	400	25	grigio scuro	13,20
FAXSMTA08004006	800	400	25	rosso mattone	13,20



RACCORDO PER TAPPETO

ART.	L mm	P mm	H mm	colore	€
FAXSMRC04001205	400	120	25	giallo	3,30



ANGOLO PER TAPPETO

ART.	L mm	P mm	H mm	colore	€
FAXSMAN01201205	120	120	25	giallo	1,80



CLIP ZINCATO

ART.	colore	€
FAXSMCLO0000099	zincato	0,30



FAMI SHOP



Scopri tutti i colori da cui scegliere il tuo armadio Fami in soli sei secondi (1000000)

Arredamenti metallici in vendita online

Scopri gli arredamenti metallici professionali per magazzino, officina, industria e ufficio in vendita su Fami Shop!



È ARRIVATO FAMI SHOP! L'E-COMMERCE SVILUPPATO PER I NOSTRI PARTNERS

+ 300 PRODOTTI

Su Fami Shop puoi trovare una vasta gamma di prodotti Fami Ideaone per arredare le diverse aree della tua azienda!

PRONTA CONSEGNA

Conoscenza immediata della disponibilità:

>10 giorni lavorativi indicati in VERDE

>20 giorni lavorativi indicati in ROSSO

FACILITÀ DI ACQUISTO

Registrati, scegli il prodotto e la quantità e aggiungi gli articoli alla tua lista dei desideri o al carrello per acquistarli subito.

CONSEGNA GRATUITA

La consegna è gratuita per gli ordini superiori a 250,00 €. Per ordini di importo inferiore, i costi di spedizione sono pari a 30,00 €.

VIRTUAL SHOW ROOM



L'EVOLUZIONE DIGITALE DI FAMI È AL TUO FIANCO IN OGNI MOMENTO.

Visita lo showroom virtuale Fami e potrai:

Vedere da vicino tutte le novità e i nostri best seller in versione 3D;

Ottenere informazioni di prodotto, attraverso grafiche, immagini a 360° e brevi video;

Acquistare i prodotti esposti, con un semplice click!

Una newsletter dedicata ti informerà del periodico aggiornamento dello showroom, con prodotti e novità sempre diversi.

CONDIZIONI GENERALI DI GARANZIA

Gentile Cliente,

ogni acquisto di prodotti di Fami S.r.l. è accompagnato da una garanzia convenzionale (la "Garanzia"), disciplinata in conformità alle modalità ed ai termini qui di seguito indicati.

1. PREMESSE:

Nelle Condizioni che seguono, i termini sotto indicati avranno il seguente significato:

a) Venditore: Fami S.r.l.

b) Acquirente: qualunque soggetto (persona fisica, società, ente, entità giuridica) che acquisti i Prodotti del Venditore;

c) Prodotto/i: i beni fabbricati, assemblati e/o commercializzati dal Venditore, esclusi i Prodotti a marchio Store Van;

2. OGGETTO DELLA GARANZIA

2.1 Fami S.r.l. garantisce che i Prodotti sono esenti da vizi e conformi alle specifiche tecniche dichiarate dal Venditore.

2.2 Resta inteso che le dimensioni dei Prodotti sono da intendersi tenendo conto dei margini di tolleranza d'uso nel commercio con riferimento al tipo, quantità, qualità dei Prodotti. Il Venditore, pertanto, non garantisce la rispondenza dei Prodotti a particolari specifiche o caratteristiche tecniche o la loro idoneità ad usi particolari diversi rispetto a quelle indicate nelle specifiche tecniche dichiarate da Fami S.r.l. e previste nel manuale d'uso e manutenzione, se non nella misura in cui tali caratteristiche siano state espressamente convenute nel contratto di vendita.

2.3 Qualora venga segnalata dal Cliente ed accertata la presenza di difetti sui Prodotti, il Cliente avrà diritto alla loro riparazione gratuita ovvero, qualora la riparazione risulti impossibile o eccessivamente onerosa, alla sostituzione gratuita del Prodotto, ad insindacabile giudizio del Venditore, con esclusione di ogni ulteriore e diversa obbligazione in capo a Fami S.r.l..

2.4 La Garanzia non pregiudica, e rimangono quindi salvi, i diritti previsti nel Decreto Legislativo 6.9.2005 n. 206 e successive modifiche ed integrazioni (il "Codice del Consumo"), nel caso in cui il Cliente sia qualificabile come "consumatore".

3. CONDIZIONI DI OPERATIVITÀ DELLA GARANZIA

3.1 Ai fini dell'attivazione della Garanzia, il Cliente avrà l'onere di informare Fami S.r.l., nei limiti temporali di cui agli articoli 4 e 5 che seguono, della scoperta di difetti tramite una segnalazione (la "Segnalazione") avente i contenuti indicati nel seguente articolo 5.

3.2 Il Cliente, fatta la Segnalazione, dovrà interrompere immediatamente l'utilizzo del/i Prodotto/i difettoso/i.

3.3 A seguito della ricezione della Segnalazione, il Venditore porrà in essere quanto necessario per accertare l'esistenza, la natura e la consistenza dei difetti e per verificare la tempestività della Segnalazione ai sensi del seguente articolo 5. A tali scopi il Cliente sarà tenuto a rendere disponibile/i il Prodotto/i difettoso/i per la loro ispezione anche tramite l'invio di documentazione fotografica ovvero l'utilizzo di sistemi di videoconferenza. Il Prodotto verrà riparato dal Venditore presso la propria sede, la propria filiale, o presso un proprio rivenditore autorizzato. Il Venditore si riserva la facoltà di riparare il Prodotto presso il Cliente. Qualora sia necessario, il Cliente dovrà provvedere ad inviare a proprie spese il Prodotto difettoso presso uno dei predetti luoghi, così come indicato dal Venditore, fatte salve le norme del Codice del Consumo. Il Venditore trasmetterà al Cliente il nuovo Prodotto o il Prodotto riparato, sostenendo i costi di spedizione.

3.4 La riparazione di un Prodotto difettoso sarà effettuata in tempi congrui rispetto all'entità del difetto.

4. DURATA – PERIODO DI COPERTURA

4.1 La durata della Garanzia per i Prodotti è di 10 anni che decorre dalla data di consegna dei Prodotti, salvo che si tratti di Prodotti commercializzati, componenti elettronici, software e le parti di usura, per i quali viene prevista una garanzia di 12 mesi che decorre, sempre, dalla data di consegna degli stessi. Si precisa che per "data di consegna" si intende la data in cui i Prodotti hanno lasciato i magazzini di Fami S.r.l. per essere consegnati al Cliente, salva diversa previsione nel contratto di vendita.

4.2 Per i Prodotti riparati o sostituiti, la garanzia decorre nuovamente ed ha una durata di 12 mesi dalla riparazione oppure dalla sostituzione. Complessivamente, pertanto, la durata della Garanzia per Prodotti riparati o sostituiti dal Venditore è di massimo 11 anni ovvero, per i Prodotti commercializzati, componenti elettronici, software e le parti di usura, di massimo 24 mesi dall'inizio della durata della Garanzia di cui al precedente articolo 4.1.

4.3 Alla scadenza del termine di cui al precedente articolo 4.1, il diritto di regresso previsto dall'art. 131 del Codice del Consumo, qualora esso sia applicabile, dovrà intendersi come prescritto ed inammissibile.

5. TEMPI E MODI DELLA SEGNALEZIONE

5.1 Durante il periodo di vigenza della Garanzia, eventuali reclami relativi allo stato dell'imballo, quantità, numero o alle caratteristiche esteriori dei Prodotti (vizi e difetti non occulti e visibili dall'esterno), dovranno essere annotati dal Cliente sulla bolla di consegna, firmando il D.D.T. indicando la dicitura "riserva specifica". Entro e non oltre 2 (due) giorni lavorativi dalla data di ricevimento dei Prodotti, il Cliente dovrà inviare al Venditore, tramite messaggio di posta elettronica al seguente indirizzo assistance@famisp.it, copia della bolla di consegna e relativo rilievo fotografico, fornendo informazioni dettagliate sulle condizioni dei Prodotti e sulla natura dei difetti rilevati.

5.2 Eventuali reclami relativi a difetti non individuabili mediante un diligente controllo al momento del ricevimento (vizi occulti) dovranno essere notificati al Venditore, a pena di decadenza, entro e non oltre 7 (sette) giorni dalla data della scoperta del difetto, tramite messaggio di posta elettronica certificata al seguente indirizzo pec@pec.famisp.it, specificando con precisione il codice prodotto, il lotto (se disponibile), la data di consegna e la natura del difetto.

6. ESCLUSIONI E LIMITAZIONE DELLA RESPONSABILITÀ

6.1 La garanzia non opera con riferimento a Prodotti i cui difetti sono dovuti a: a) operazioni di trasporto; b) mancato rispetto di accorgimenti rientranti nell'ordinaria prassi di manutenzione; negligenza e trascuratezza nell'uso; c) mancata osservanza delle istruzioni fornite dal Venditore per l'utilizzo e/o lo stoccaggio del Prodotto; d) mancato rispetto delle norme d'installazione e/o di ogni altra indicazione o istruzione riportata sulle note tecniche a corredo del Prodotto qualora l'installazione non sia stata curata direttamente dal Venditore; e) manomissioni, manutenzioni in genere, interventi operati al Cliente o da personale non autorizzato dal Venditore; f) uso anomalo e/o improprio del Prodotto, collocazione dello stesso in locali umidi, eccessivamente caldi o freddi, polverosi o aggressivi (presenza di cloro, lacche, vernici o altri agenti chimici e/o tossici) o comunque in locali non idonei alla corretta conservazione dei Prodotti nei limiti in cui tali circostanze non siano state documentate al Venditore prima dell'acquisto dei Prodotti ed il Venditore abbia garantito la tollerabilità dei Prodotti a tali ambienti; g) aggravio dei danni causato dall'utilizzo dei Prodotti da parte del Cliente una volta che si siano manifestati i difetti; h) utilizzo di parti di ricambio, componenti ed accessori non originali o non consigliati dal Venditore (non può essere richiesta la sostituzione o la riparazione di pezzi non originali) e danni provocati al Prodotto dall'uso degli stessi; i) anomalie o difettoso funzionamento dell'alimentazione elettrica;

l) corrosioni, incrostazioni o rotture provocate da correnti vaganti, condense, aggressività o acidità dell'acqua, trattamenti disincrostanti effettuati impropriamente, depositi di fanghi o calcare; m) caso fortuito, cause di forza maggiore quali, a titolo esemplificativo e non esaustivo, gelo, surriscaldamento, incendio, furto, eventi naturali (come ad esempio, grandine, trombe d'aria, fulmini, inondazioni, terremoti), atti vandalici, incidenti e altri simili avvenimenti.

6.2 La Garanzia non opera se il prezzo di vendita dei Prodotti non è stato interamente saldato, con la precisazione che qualora il pagamento sia previsto in più scadenze, la Garanzia sarà da subito operativa e rimarrà tale fino a quando le scadenze di pagamento resteranno tempestivamente onorate.

6.3 Il Venditore non è responsabile per eventuali danni che possano, direttamente o indirettamente, derivare a persone, cose o animali, in conseguenza della mancata osservanza di tutte le prescrizioni indicate nel libretto di installazione, uso e manutenzione.

6.4 Il Venditore declina ogni responsabilità relativa a danni indiretti causati dalla difettosità di un Prodotto come, a titolo puramente indicativo ma non esaustivo, il fermo di produzione ovvero la mancata spedizione o cessione a terzi del Prodotto.

6.5 In ogni caso, la responsabilità del Venditore non potrà comunque eccedere il prezzo pagato dal Cliente per il singolo contratto di vendita dal cui contenuto è derivata la fattispecie inerente all'eventuale richiesta di danno e/o risarcimento.

6.6 I Prodotti dovranno essere utilizzati solo ed esclusivamente per gli scopi indicati e nel rispetto delle normative sulla sicurezza, conformemente alle previsioni del manuale di installazione, uso e manutenzione fornito dal Venditore; nel caso in cui il Cliente dovesse utilizzare o rivendere i Prodotti acquistati e/o Prodotti dal Venditore per scopi diversi, lo fa a proprio esclusivo rischio e pericolo, con ogni conseguente responsabilità. In tal caso, è esclusa la responsabilità contrattuale e/o extracontrattuale del Venditore per eventuali danni diretti ed indiretti subiti anche da terzi, nonché in caso di cattiva manutenzione, utilizzo improprio, non osservanza di norme di sicurezza ed altre ipotesi e il Cliente dovrà tenere il Venditore indenne da costi e/o responsabilità che potrebbero derivare a suo carico.

7. FORO COMPETENTE E LEGGE APPLICABILE

7.1 Per qualunque controversia derivante o connessa alle presenti Condizioni Generali di Garanzia quali, a titolo meramente esemplificativo e non esaustivo, controversie relative alla loro esistenza, validità, interpretazione, efficacia, esecuzione, è competente a decidere in via esclusiva il Tribunale di Vicenza, anche qualora il Contratto presenti elementi di internazionalità, fatte salve le norme inderogabili del Codice del Consumo.

7.2 Le presenti Condizioni Generali di Garanzia sono interamente soggetti alla legge italiana e interpretati secondo la stessa, anche qualora il Contratto presenti elementi di internazionalità, con espressa esclusione della Convenzione di Vienna del 1980.

CONDIZIONI GENERALI DI VENDITA

1. Definizioni

1.1 Nel contesto delle presenti Condizioni, i termini di seguito indicati avranno il seguente significato:

- a) Venditore: Fami S.r.l.
- b) Acquirente: qualunque società, ente, entità giuridica che acquisti i Prodotti del Venditore;
- c) Prodotti: i beni fabbricati, assemblati e/o commercializzati dal Venditore;
- d) Ordine: ciascuna proposta di acquisto dei Prodotti inoltrata dall'Acquirente al Venditore;
- e) Conferma d'Ordine: l'accettazione scritta dell'Ordine da parte del Venditore;
- f) Contratto: la vendita conclusa tra il Venditore e l'Acquirente a seguito del ricevimento da parte dell'Acquirente della Conferma d'Ordine.
- g) Parti: il Venditore e l'Acquirente congiuntamente;
- h) Marchi: tutti i marchi di cui il Venditore è proprietario o licenziatario;
- i) Diritti di Proprietà Intellettuale: tutti i diritti di proprietà intellettuale e/o industriale di Fami S.r.l., ivi inclusi, senza limitazione alcuna, i diritti relativi a: brevetti per invenzioni, disegni o modelli, modelli di utilità, Marchi, know-how, specifiche tecniche, dati, software, indipendentemente dalla registrazione o meno di tali diritti, nonché qualsivoglia domanda o registrazione relativa a tali diritti ed ad ogni altro diritto o forma di protezione di natura similare o avente effetto equivalente.

2. Disposizioni Generali

- 2.1 Le presenti Condizioni Generali di Vendita (di seguito, le "Condizioni") formano parte integrante dei Contratti conclusi tra il Venditore e l'Acquirente per la fornitura dei Prodotti.
- 2.2 Le Condizioni si applicano tra Fami S.r.l. (di seguito, "Fami") e l'Acquirente senza la necessità che vi sia un espresso richiamo alle stesse o uno specifico accordo in tal senso. Qualsiasi condizione o termine differente trova applicazione soltanto se confermato per iscritto da parte del Venditore.
- 2.3 Il Venditore si riserva il diritto di modificare, integrare o eliminare qualsiasi previsione delle presenti Condizioni Generali di Vendita, in qualsiasi momento, dandone notizia anche tramite la pagina a ciò dedicata del sito aziendale, restando inteso che tali aggiunte, modifiche o cancellazioni si applicheranno a tutte le Vendite concluse a partire dal 15° giorno successivo alla comunicazione (tramite pubblicazione sul sito web oppure tramite invio di newsletter o qualsivoglia corrispondenza inviata per iscritto) all'Acquirente delle nuove Condizioni di Vendita.
- 2.4 Qualsiasi riferimento a termini commerciali (come EXW, DPA, DPU, DDP, etc.) è da intendersi come richiamo agli Incoterms® della Camera di Commercio Internazionale, nel testo in vigore alla data di stipulazione del Contratto.

3. Ambito di applicazione

- 3.1 Le presenti Condizioni Generali di Vendita (di seguito, le "Condizioni") si applicano a tutti i Contratti (siano essi conclusi telefonicamente, a mezzo telefax, e-mail o sito internet), ove non espressamente derogate per iscritto dalle Parti e formano parte integrante e sostanziale di ogni Ordine, Conferma d'Ordine, anche se non espressamente citate.
- 3.2 L'Acquirente non può invocare né eccepire condizioni diverse dalle presenti Condizioni. Pertanto, non hanno alcuna validità le eventuali condizioni precisate per iscritto dall'Acquirente sull'Ordine, ovvero in qualsiasi altra fase della trattativa contrattuale nonché successivamente alla Conferma d'Ordine, così come le eventuali condizioni generali di acquisto dell'Acquirente stesso. Qualsiasi condizione scritta o verbale inviata da parte di collaboratori, dipendenti, agenti o rappresentanti del Venditore è priva di valore se non riprodotta nel testo della Conferma d'Ordine o se non confermata per iscritto dal Venditore. In tal senso, l'esecuzione, anche parziale, dell'Ordine da parte di Fami od ogni altro suo adempimento nei confronti dell'Acquirente non valgono e non possono essere interpretati come tacita o implicita accettazione di qualsivoglia condizione generale di contratto che non sia stata espressamente sottoscritta da Fami.
- 3.3 Le Condizioni sono valide esclusivamente per rapporti contrattuali tra Fami e operatori professionali, per cui non troverà alcuna applicazione il D.Lgs. 6 settembre 2005, n. 206 (Codice del Consumo) e successive modifiche.

4. Offerte e Ordini

- 4.1 Le offerte del Venditore non sono da considerarsi vincolanti. Le indicazioni riportate su cataloghi, prospetti e listini non impegnano il Venditore, che si riserva la facoltà di apportare qualsiasi modifica ai Prodotti ed ai relativi prezzi; pertanto, il Venditore si considera vincolato esclusivamente da quanto riportato nella Conferma d'Ordine.
- 4.2 Ciascun Ordine inviato dall'Acquirente, sia direttamente a Fami sia per il tramite degli agenti o dei rappresentanti del Venditore, è da intendersi come una proposta irrevocabile d'acquisto, destinata a rimanere efficace per 30 (trenta) giorni, decorrenti dalla data della sua regolare ricezione da parte del Venditore, salvo esplicita deroga indicata di volta in volta.
- 4.3 L'invio dell'Ordine da parte dell'Acquirente implica l'integrale presa visione e la conoscenza da parte dello stesso di tutte le presenti Condizioni, le quali dovranno quindi intendersi integralmente accettate dall'Acquirente senza limitazioni e riserve.
- 4.4 Gli Ordini e/o le eventuali modifiche degli Ordini effettuati verbalmente o telefonicamente devono essere confermati per iscritto da parte dell'Acquirente. In caso contrario, il Venditore non si assume alcuna responsabilità con riguardo ad eventuali errori o possibili fraintendimenti.
- 4.5 Il Venditore si riserva espressamente di valutare ogni Ordine, non essendo vincolato alla loro accettazione.
- 4.6 Gli Ordini regolarmente accettati dal Venditore mediante Conferma d'Ordine non potranno essere annullati dal Compratore senza il consenso scritto del Venditore.

5. Conclusione del Contratto

- 5.1 Il Contratto potrà dirsi concluso solo a seguito dell'invio di una Conferma d'Ordine da parte di Fami (via e-mail, telefax o altri mezzi telematici equipollenti), con riferimento ad ogni singolo Ordine. In ogni caso, l'emissione della fattura da parte del Venditore oppure l'esecuzione dell'Ordine da parte del Venditore sarà considerata quale conferma.
- 5.2 Qualora la Conferma d'Ordine contenga aggiunte, limitazioni o altre variazioni rispetto all'Ordine, l'assenso dell'Acquirente a tali variazioni si intenderà tacitamente prestato salvo contestazione scritta da far pervenire per iscritto al Venditore entro 2 giorni lavorativi dal ricevimento della stessa.
- 5.3 Modifiche e integrazioni richieste dall'Acquirente successivamente alla conclusione del Contratto non avranno valore ed efficacia se non accettate per iscritto da parte del Venditore, con l'eventuale precisazione dei nuovi termini di consegna, del prezzo e delle modalità di pagamento.
- 5.4 Tutti i Contratti si intendono sempre conclusi presso la sede legale di Fami S.r.l. in Italia, 36027 Rosà (Vi), Via Stazione Rossano n. 13

6. Prezzi

- 6.1 I prezzi dei Prodotti saranno quelli indicati nel listino prezzi del Venditore in vigore al momento della conclusione dell'Ordine o, qualora il Prodotto non sia inserito nel listino prezzi o il listino prezzi non sia disponibile, quelli indicati nella Conferma d'Ordine.
- 6.2 I prezzi dei Prodotti saranno quelli indicati nella Conferma d'Ordine e, salvo patto contrario, si intendono per merce resa franco fabbrica [EXW]. Tali prezzi, fatta salva diversa indicazione nella Conferma d'Ordine, non comprendono i costi e le spese di imballaggi speciali, spedizione, assicurazione e trasporto dai locali del Venditore, ogni spesa, tassa o imposta inerente alla vendita dei Prodotti, inclusi i costi di tutte le formalità doganali [a titolo esemplificativo e non esaustivo: dazi, tasse ed altri oneri per l'esportazione dei Prodotti], che restano a carico dell'Acquirente.
- 6.3 Il Venditore si riserva il diritto di effettuare un adeguamento del prezzo nel caso di modifica [a] del Contratto, richiesto dall'Acquirente successivamente alla conclusione dello stesso ed accettato dal Venditore e [b] del tipo della fornitura, del materiale o dell'esecuzione dei Prodotti dovuti all'incompletezza ovvero alla non correttezza delle informazioni e/o della documentazione fornita dall'Acquirente.

7. Termini di pagamento

- 7.1 Al momento della conclusione del contratto, il Venditore potrà richiedere all'Acquirente il versamento di una caparra confirmatoria pari al 30% del valore della fornitura. Le Parti in ogni caso possono pattuire il versamento di una caparra confirmatoria diversa previo accordo per iscritto nel Contratto.
- 7.2 In caso di mancato versamento della caparra confirmatoria, ove prevista, il Contratto si intende risolto ipso iure ed il Venditore potrà richiedere il pagamento delle somme sin a quel momento maturate, oltre al risarcimento di tutti i danni patrimoniali e non patrimoniali, nonché le spese, anche legali, eventualmente sostenute.
- 7.3 Ove nel Contratto non vengano precisate le condizioni di pagamento, esso dovrà essere effettuato a 30 gg. data fattura fine mese, mediante bonifico bancario. Il pagamento si considera effettuato quando la somma entra nella disponibilità del Venditore presso la sua Banca in Italia. Ove le Parti abbiano pattuito il pagamento anticipato senza ulteriori indicazioni, si presume che il pagamento anticipato si riferisca all'intero prezzo dei Prodotti inclusi nella fornitura. In caso di consegna ripartita in più soluzioni, l'acquirente dovrà, per ognuna di esse, versare l'importo corrispondente alla merce consegnata, salvo diverso accordo scritto previsto nel Contratto.
- 7.4 I pagamenti devono essere effettuati nella valuta concordata ed eventuali spese o commissioni bancarie dovute in relazione al pagamento saranno integralmente a carico dell'Acquirente.
- 7.5 In caso di mancato o ritardato pagamento, anche parziale, da parte dell'Acquirente, il Venditore, salvi tutti gli altri suoi diritti, avrà facoltà di sospendere le ulteriori consegne anche se queste fossero dovute in dipendenza di altri contratti e richiedere l'immediato ed integrale pagamento di tutto il materiale ordinato nonché di differire le proprie consegne per un termine pari al ritardo nei pagamenti, qualunque ne sia l'importo e ciò sino al saldo di tali pagamento e dei relativi interessi moratori.
- 7.6 Sui mancati e ritardati pagamenti il Venditore ha diritto al riconoscimento e al pagamento a suo favore degli interessi di mora ex D.Lgs. 231/2002, oltre alle spese, anche legali, che dovessero ritenersi necessarie per il recupero delle somme a qualsiasi titolo spettanti al Venditore.
- 7.7 Il mancato pagamento anche di una sola fattura comporterà per il Venditore il diritto di risolvere ogni Contratto in essere con l'Acquirente ai sensi dell'art. 1456 c.c. e di sospendere l'evasione o la consegna di ogni altra fornitura in corso di esecuzione, salvo in ogni caso il risarcimento integrale del danno conseguito dall'inadempimento o dal ritardo dell'Acquirente. Eventuali ritardi nell'evasione degli Ordini o nelle consegne causati da precedenti sospensioni della produzione per mancati pagamenti dell'Acquirente non costituiranno inadempimento del Venditore.
- 7.8 Qualsiasi reclamo o contestazione non darà diritto all'Acquirente di sospendere o ritardare i pagamenti.

8. Termini di consegna

- 8.1 Il termine di consegna sarà quella indicati nella Conferma d'Ordine e, salvo patto contrario, si intende stabilita ex-works [EXW] presso lo stabilimento del Venditore. Se richiesto ed espressamente pattuito per iscritto nel Contratto, Fami si occuperà del trasporto dei Prodotti a rischio, costi e spese dell'Acquirente. Le eventuali spese di trasposto saranno a carico dell'Acquirente e ciò non inciderà

in alcun modo sui rischi della spedizione che resteranno anche essi in capo all'Acquirente al più tardi con la consegna dei Prodotti al primo trasportatore.

8.2. La consegna dei Prodotti dovrà avvenire entro il termine indicato nel Contratto, computato in giorni lavorativi, precisato peraltro che i termini di consegna restano puramente indicativi e non sono termini essenziali e, in ogni caso, non includono i tempi di trasporto. Il Venditore, quindi, non risponderà del ritardo nella consegna per alcun motivo.

8.3. Qualora l'Acquirente richieda al Venditore una variazione del termine di consegna, dovrà effettuare la relativa richiesta per iscritto e procedere comunque al saldo della fornitura entro i termini indicati nell'articolo 7 delle presenti Condizioni. Restano esclusi i soli eventuali costi di custodia, consegna, montaggio, smontaggio e installazione, i quali dovranno essere saldati entro la nuova data di consegna pattuita.

8.4. Dal ricevimento dell'avviso di merce pronta l'Acquirente dovrà ritirare la merce nel termine massimo di 10 (dieci) giorni. In difetto, i Prodotti potranno essere stoccati all'aperto, con esonero del Venditore da ogni responsabilità e decadenza, a beneficio di quest'ultima, di tutte le garanzie e con addebito all'Acquirente dei costi di movimentazione e magazzinaggio, nonché di ogni altra eventuale spesa, sostenuti dal Venditore, che altresì si riserva la facoltà di far depositare la merce a spese dell'Acquirente.

8.5 Entro 10 (dieci) giorni dall'avviso di merce pronta il Venditore avrà la facoltà di emettere regolare fattura.

8.6 In caso di ritardo nel ritiro della merce, comunque approntata, per una qualsiasi ragione non dipendente dalla volontà del Venditore, la consegna si intenderà comunque come eseguita decorsi dieci giorni dalla comunicazione dell'avviso di merce pronta. In tal caso il Venditore avrà il diritto di procedere alla fatturazione e di reclamare l'adempimento delle condizioni di pagamento pattuite e potrà far effettuare l'imballaggio, il trasporto o lo stoccaggio della merce a spese dell'Acquirente, salvo il risarcimento dei danni eventualmente patiti, anche per l'immagazzinamento, la custodia ed il deposito della merce.

9. Garanzia e Reclami

9.1. La regolamentazione sulla Garanzia offerta dal Venditore è contenuta nel documento Condizioni Generali di Garanzia visionabile sul sito www.famispaspa.com e, per quanto riguarda esclusivamente i Prodotti a marchio Store Van, nel documento Condizioni Generali di Garanzia visionabile sul sito www.storevan.com.

9.2 Al momento della presa in consegna dei Prodotti, l'Acquirente è tenuto ad esaminare i Prodotti alla presenza del trasportatore incaricato della consegna per verificare l'eventuale presenza di difetti visibili dall'esterno (a titolo esemplificativo e non esaustivo, le quantità e l'imballaggio dei Prodotti, la conformità dei Prodotti rispetto a quanto indicato nella Conferma d'Ordine).

9.3 Eventuali reclami relativi allo stato dell'imballo, quantità, numero o alle caratteristiche esteriori dei Prodotti (vizi e difetti non occulti e visibili dall'esterno), dovranno essere annotati dall'Acquirente sulla bolla di consegna, firmando il D.D.T. indicando la dicitura "riserva specifica". Entro e non oltre 2 (due) giorni lavorativi dalla data di ricevimento dei Prodotti, l'Acquirente dovrà inviare al Venditore, tramite messaggio di posta elettronica al seguente indirizzo assistance@famispaspa.it, copia della bolla di consegna e relativo rilievo fotografico, fornendo informazioni dettagliate sulle condizioni dei Prodotti e sulla natura dei difetti rilevati.

9.4 Fatti salvi i termini di durata della Garanzia offerta dal Venditore, eventuali reclami relativi a difetti non individuabili mediante un diligente controllo al momento della presa in consegna dei Prodotti (vizi e difetti occulti) dovranno essere notificati al Venditore, a pena di decadenza, entro e non oltre 7 (sette) giorni dalla data della scoperta del difetto, tramite messaggio di posta elettronica certificata al seguente indirizzo pec@pec.famispaspa.it, specificando il codice prodotto, il lotto (se disponibile), la data di consegna e la natura del difetto.

9.5 Qualsiasi Prodotto per il quale non sia stata sollevata alcuna contestazione conformemente alle procedure ed ai termini qui sopra indicati viene considerato approvato ed accettato dall'Acquirente.

9.6 In nessun caso agenti, clienti o intermediari del Venditore hanno il potere di rappresentare ed impegnare quest'ultima nei confronti dell'Acquirente o di altre terze parti. A tal fine ogni comunicazione relativa a vizi e difetti dei Prodotti sarà invalida ed inefficace qualora sia stata fatta ad agenti, clienti o intermediari del Venditore, ovvero in forme o modalità diverse da quelle sopraindicate.

10. Riserva di proprietà

10.1 I Prodotti rimangono di proprietà del Venditore fino alla data in cui l'Acquirente non abbia provveduto al pagamento dell'intero prezzo degli stessi e di tutte le somme dovute al Venditore.

10.2 Nel caso in cui nel paese in cui l'Acquirente ha la propria sede, per la validità della riserva di proprietà a favore del Venditore sia necessario l'espletamento di formalità amministrative o legali quali, senza alcuna limitazione, la registrazione dei Prodotti in pubblici registri, ovvero l'apposizione sugli stessi di appositi sigilli, l'Acquirente si impegna fin d'ora a collaborare con il Venditore e a porre in essere tutti gli atti necessari al fine di far ottenere a quest'ultimo un valido diritto, anche nei confronti di eventuali soggetti terzi, con riferimento alla riserva di proprietà.

11. Forza Maggiore

11.1 Sia l'Acquirente che Fami potranno sospendere l'esecuzione dei loro obblighi contrattuali quando tale esecuzione sia resa impossibile o irragionevolmente onerosa da un impedimento imprevedibile ed indipendente dalla loro volontà quale a titolo esemplificativo, non esaustivo, scioperi, epidemia e/o pandemia, boicottaggi, serratte, incendi, guerre, sommosse e rivoluzioni, requisizioni, embarghi, interruzioni di energia.

11.2 La Parte che desiderasse avvalersi della presente clausola dovrà comunicare immediatamente per iscritto, a mezzo posta elettronica certificata, all'altra il verificarsi e la cessazione delle circostanze di forza maggiore.

11.3 Qualora la sospensione dovuta a forza maggiore duri più di otto settimane, ciascuna Parte avrà il diritto di risolvere l'Ordine, previo un preavviso di 10 giorni, da comunicarsi all'altra per iscritto, mediante raccomandata con ricevuta di ritorno o mediante comunicazione a mezzo posta elettronica certificata.

11.4 In ogni caso, resta inteso che il Venditore avrà diritto di ottenere il pagamento dei Prodotti eventualmente già consegnati, oltre al rimborso di eventuali spese già sostenute.

12. Mutamento nelle condizioni patrimoniali dell'Acquirente

12.1 Fami avrà diritto a sospendere l'adempimento delle obbligazioni derivanti dalla fornitura dei Prodotti nel caso in cui le condizioni patrimoniali dell'Acquirente divenissero tali da porre in serio pericolo il conseguimento della controprestazione, salvo che sia prestata idonea garanzia. Resta inteso che il Venditore avrà diritto di ottenere il pagamento dei Prodotti eventualmente già consegnati, oltre al rimborso di eventuali spese già sostenute.

13. Proprietà intellettuali

13.1 I Diritti di Proprietà Intellettuale sono di totale ed esclusiva proprietà del Venditore e la loro comunicazione o utilizzo nell'ambito delle presenti Condizioni non crea, in relazione ad essi, alcun diritto o pretesa in capo all'Acquirente. Quest'ultimo si obbliga a non compiere alcun atto incompatibili con la titolarità dei Diritti di Proprietà Intellettuale.

13.2 L'Acquirente dichiara che: a) il Venditore è l'esclusivo titolare dei Marchi; b) si asterrà dall'utilizzare e da registrare marchi simili e/o confondibili con i Marchi; c) utilizzerà i Marchi esclusivamente in ottemperanza alle istruzioni del Venditore ed esclusivamente per i fini di cui alle presenti Condizioni.

14. Foro competente e legge applicabile

14.1 Per qualunque controversia derivante o connessa alle presenti Condizioni Generali di vendita e/o al singolo Contratto quali, a titolo meramente esemplificativo e non esaustivo, controversie relative alla loro esistenza, validità, interpretazione, efficacia, esecuzione, è competente a decidere in via esclusiva il Tribunale di Vicenza, anche qualora il Contratto presenti elementi di internazionalità.

14.2 In deroga a quanto sopra stabilito, il Venditore ha comunque la facoltà di portare la controversia davanti al giudice competente presso la sede dell'Acquirente.

14.3 Le presenti Condizioni Generali di vendita e/o ogni singolo Contratto sono interamente soggetti alla legge italiana e interpretati secondo la stessa, anche qualora il Contratto presenti elementi di internazionalità, con espressa esclusione della Convenzione di Vienna del 1980.

15. Privacy

15.1. L'Acquirente dichiara di aver ricevuto tutte le informazioni previste ai sensi dell'art. 13 del Regolamento UE n. 2016/679 (GDPR) e presta il consenso al trattamento dei dati personali per le finalità di cui alle presenti condizioni generali di vendita e di essere stato informato che in relazione ai dati conferiti è possibile esercitare i diritti previsti dal D. Lgs. n. 196/2003 e del Regolamento UE n. 2016/679 (GDPR). Il Venditore dichiara che il titolare del trattamento dei dati raccolti è Fami S.r.l., con sede legale in Rosà (VI), Via Stazione Rossano n. 13, partita IVA e codice fiscale 03498610249

16. Osservanza della L. 231/2001

16.1 L'Acquirente prende atto che Fami S.r.l. ha adottato ed attua un Modello di Organizzazione, Gestione e Controllo ex D.lgs. 231/01, con i relativi Codice Etico e Sistema Disciplinare i cui dettagli possono essere visionati sul sito aziendale www.famispaspa.com. L'Acquirente aderisce ai principi al suddetto Modello di organizzazione, gestione e controllo nonché ai suoi allegati e si impegna a rispettarne i contenuti, i principi, e le procedure e, in generale, ad astenersi da qualsivoglia comportamento atto a configurare le ipotesi di reato indicate nel D.lgs 231/01 e sue successive modifiche ed integrazioni e riportate nel predetto Modello di organizzazione, gestione e controllo. L'Acquirente si impegna inoltre a rispettare e a far rispettare ad eventuali suoi collaboratori, tutti i principi contenuti nella suddetta documentazione ed i Protocolli comportamentali previsti dalla nostra organizzazione ai sensi del D. Lgs. 231/2001 ed allegati al presente contratto. La violazione delle regole previste dai sopraccitati documenti rappresenterà grave inadempimento contrattuale.

17. Disposizioni finali

17.1 Qualora una delle Parti ometta di intraprendere un'azione giudiziale o di esercitare un diritto in base alle presenti Condizioni, tale comportamento di acquiescenza non potrà essere interpretato come una definitiva rinuncia ad esercitare in futuro la stessa azione giudiziale o lo stesso diritto.

17.2 La vendita dei Prodotti da parte di Fami all'Acquirente non fa sorgere a favore di quest'ultimo un diritto di esclusiva territoriale né consente all'Acquirente di assumere la qualità di distributore o concessionario di Fami.

17.3 L'invalidità in tutto o in parte di singole disposizioni delle presenti Condizioni non inficia la validità delle restanti previsioni.

BREVETTI

Alcuni componenti sono protetti da modello di design comunitario e/o brevetto di invenzione industriale.

CLEVER LARGE



WWW.FAMISPA.COM

VIA STAZIONE ROSSANO 13
36027 ROSÀ (VICENZA) ITALIA

TEL. +39 0424 58 54 55
FAX +39 0424 58 54 70

E-MAIL: INFO@FAMISPA.IT

TIMBRO RIVENDITORE